

Lanner

Network Appliance Platform

Hardware Platforms for Network Computing

NCA-6110 User Manual

Version: 1.0

Date of Release:2020-02-10

About this Document

This manual describes the overview of the various functionalities of this product and the information you need to get it ready for operation. It is intended for those who are:

- responsible for installing, administering and troubleshooting this system or information technology professionals.
- assumed to be qualified in the servicing of computer equipment, such as professional system integrators, or service personnel and technicians.

The latest version of this document can be found on Lanner's official website, available either through the product page or through the [Lanner Download Center](#) page with a login account and password.



Conventions & Icons

This document utilizes different font types and icons in order to make selected text more transparent and explicable to users. This document contains the following conventions:

Font Conventions

Example	Convention	Usage
<code>iptables -F</code>	Monospace, shaded	A command to be entered at a shell command-line
Setup page	Bold	A title of a dialog box or a page
<Enter>	Between a pair of inequality signs	A physical keyboard button
"Menu"	Between a pair of quotation marks	A menu option or a software button to be clicked
<i>Readme.txt</i>	In Italic	A filename or a file path
<u>IPMI User Guide</u>	Underlined	The name of another document or a chapter in this document

Icon Descriptions

Icon	Usage
 Note or Information	This mark indicates that there is something you should pay special attention to while using the product.
 Warning or Important	This mark indicates that there is a caution or warning and it is something that could damage your property or product.

Online Resources

To obtain additional documentation resources and software updates for your system, please visit the [Lanner Download Center](#). As certain categories of documents are only available to users who are logged in, please be registered for a Lanner Account at <http://www.lannerinc.com/> to access published documents and downloadable resources.

For troubleshooting the issues with your system, please visit the [Lanner Q&A](#) page for diagnostic procedures and troubleshooting steps.

Technical Support

In addition to contacting your distributor or sales representative, you could submit a request to our **Lanner Technical Support** at <http://www.lannerinc.com/technical-support> where you can fill in a support ticket to our technical support department.

Copyright and Trademarks

This document is copyrighted © 2020 by Lanner Electronics Inc. All rights are reserved. The original manufacturer reserves the right to make improvements to the products described in this manual at any time without notice.

No part of this manual may be reproduced, copied, translated or transmitted in any form or by any means without the prior written permission of the original manufacturer.

Information provided in this manual is intended to be accurate and reliable. However, the original manufacturer assumes no responsibility for its use, nor for any infringements upon the rights of third parties that may result from such use.

Documentation Feedback

Your feedback is valuable to us, as it will help us continue to provide you with more accurate and relevant documentation. To provide any feedback, comments or to report an error, please email to contact@lannerinc.com. Thank you for your time.

Contact Information

Taiwan Corporate Headquarters

Lanner Electronics Inc.

7F, No.173, Sec.2, Datong Rd. Xizhi District,
New Taipei City 22184, Taiwan

立端科技股份有限公司

221 新北市汐止區
大同路二段 173 號 7 樓
T: +886-2-8692-6060
F: +886-2-8692-6101

E: contact@lannerinc.com

China

Beijing L&S Lancom Platform Tech. Co., Ltd.

Guodong LOFT 9 Layer No. 9 Huinan Road,
Huilongguan Town, Changping District, Beijing
102208 China

T: +86 010-82795600

F: +86 010-62963250

E: service@ls-china.com.cn

USA

Lanner Electronics Inc.

47790 Westinghouse Drive Fremont, CA 94539

T: +1-855-852-6637

F: +1-510-979-0689

E: sales_us@lannerinc.com

Canada

LEI Technology Canada Ltd

3160A Orlando Drive Mississauga, ON L4V 1R5
Canada

T: +1 877-813-2132

F: +1 905-362-2369

E: sales_ca@lannerinc.com

Aknowledgments

AMD is a trademark of Advanced Micro Devices, Inc.

Microsoft®, Windows®, and Windows Server® are either registered trademarks or trademarks of Microsoft Corporation in the United States and/or other countries.

All other product names or trademarks are properties of their respective owners.

Federal Communication Commission Interference Statement

This equipment has been tested and found to comply with the limits for a Class A digital device, pursuant to Part 15 of FCC Rules. These limits are designed to provide reasonable protection against harmful interference in a residential installation. This equipment generates, uses and can radiate radio frequency energy and, if not installed and used in accordance with the instruction, may cause harmful interference to radio communications. However, there is no guarantee that interference will not occur in a particular installation. If this equipment does cause harmful interference to radio or television reception, which can be determined by turning the equipment off and on, the user is encouraged to try to correct the interference by one or more of the following measures:

- ▶ Reorient or relocate the receiving antenna.
- ▶ Increase the separation between the equipment and receiver.
- ▶ Connect the equipment into an outlet on a circuit different from that to which the receiver is connected.
- ▶ Consult the dealer or an experienced radio/TV technician for help.

FCC Caution

- ▶ Any changes or modifications not expressly approved by the party responsible for compliance could void the user's authority to operate this equipment.
- ▶ This transmitter must not be co-located or operating in conjunction with any other antenna or transmitter.



Note

1. An unshielded-type power cord is required in order to meet FCC emission limits and also to prevent interference to the nearby radio and television reception. It is essential that only the supplied power cord be used.
2. Use only shielded cables to connect I/O devices to this equipment.
3. Changes or modifications not expressly approved by the party responsible for compliance could void the user's authority to operate the equipment.



Important

1. Operations in the 5.15-5.25GHz band are restricted to indoor usage only.
2. This device meets all the other requirements specified in Part 15E, Section 15.407 of the FCC Rules.

Safety Guidelines

Follow these guidelines to ensure general safety:

- ▶ Keep the chassis area clear and dust-free during and after installation.
- ▶ Do not wear loose clothing or jewelry that could get caught in the chassis. Fasten your tie or scarf and roll up your sleeves.
- ▶ Wear safety glasses if you are working under any conditions that might be hazardous to your eyes.
- ▶ Do not perform any action that creates a potential hazard to people or makes the equipment unsafe.
- ▶ Disconnect all power by turning off the power and unplugging the power cord before installing or removing a chassis or working near power supplies
- ▶ Do not work alone if potentially hazardous conditions exist.
- ▶ Never assume that power is disconnected from a circuit; always check the circuit.

Consignes de sécurité

Suivez ces consignes pour assurer la sécurité générale :

- ▶ Laissez la zone du châssis propre et sans poussière pendant et après l'installation.
- ▶ Ne portez pas de vêtements amples ou de bijoux qui pourraient être pris dans le châssis. Attachez votre cravate ou écharpe et remontez vos manches.
- ▶ Portez des lunettes de sécurité pour protéger vos yeux.
- ▶ N'effectuez aucune action qui pourrait créer un danger pour d'autres ou rendre l'équipement dangereux.
- ▶ Coupez complètement l'alimentation en éteignant l'alimentation et en débranchant le cordon d'alimentation avant d'installer ou de retirer un châssis ou de travailler à proximité de sources d'alimentation.
- ▶ Ne travaillez pas seul si des conditions dangereuses sont présentes.
- ▶ Ne considérez jamais que l'alimentation est coupée d'un circuit, vérifiez toujours le circuit. Cet appareil génère, utilise et émet une énergie radiofréquence et, s'il n'est pas installé et utilisé conformément aux instructions des fournisseurs de composants sans fil, il risque de provoquer des interférences dans les communications radio.

Lithium Battery Caution

- ▶ There is risk of explosion if the battery is replaced by an incorrect type.
- ▶ Dispose of used batteries according to the instructions.
- ▶ Installation should be conducted only by a trained electrician or only by an electrically trained person who knows all installation procedures and device specifications which are to be applied.
- ▶ Do not carry the handle of power supplies when moving to another place.
- ▶ Please conform to your local laws and regulations regarding safe disposal of lithium battery.
- ▶ Disposal of a battery into fire or a hot oven, or mechanically crushing or cutting of a battery can result in an explosion.

- ▶ Leaving a battery in an extremely high temperature environment can result in an explosion or the leakage of flammable liquid or gas.
- ▶ A battery subjected to extremely low air pressure may result in an explosion or the leakage of flammable liquid or gas.

Avertissement concernant la pile au lithium

- ▶ Risque d'explosion si la pile est remplacée par une autre d'un mauvais type.
- ▶ Jetez les piles usagées conformément aux instructions.
- ▶ L'installation doit être effectuée par un électricien formé ou une personne formée à l'électricité connaissant toutes les spécifications d'installation et d'appareil du produit.
- ▶ Ne transportez pas l'unité en la tenant par le câble d'alimentation lorsque vous déplacez l'appareil.

Operating Safety

- ▶ Electrical equipment generates heat. Ambient air temperature may not be adequate to cool equipment to acceptable operating temperatures without adequate circulation. Be sure that the room in which you choose to operate your system has adequate air circulation.
- ▶ Ensure that the chassis cover is secure. The chassis design allows cooling air to circulate effectively. An open chassis permits air leaks, which may interrupt and redirect the flow of cooling air from internal components.
- ▶ Electrostatic discharge (ESD) can damage equipment and impair electrical circuitry. ESD damage occurs when electronic components are improperly handled and can result in complete or intermittent failures. Be sure to follow ESD-prevention procedures when removing and replacing components to avoid these problems.
- ▶ Wear an ESD-preventive wrist strap, ensuring that it makes good skin contact. If no wrist strap is available, ground yourself by touching the metal part of the chassis.
- ▶ Periodically check the resistance value of the antistatic strap, which should be between 1 and 10 megohms (Mohms).

Sécurité de fonctionnement

- ▶ L'équipement électrique génère de la chaleur. La température ambiante peut ne pas être adéquate pour refroidir l'équipement à une température de fonctionnement acceptable sans circulation adaptée. Vérifiez que votre site propose une circulation d'air adéquate.
- ▶ Vérifiez que le couvercle du châssis est bien fixé. La conception du châssis permet à l'air de refroidissement de bien circuler. Un châssis ouvert laisse l'air s'échapper, ce qui peut interrompre et rediriger le flux d'air frais destiné aux composants internes.
- ▶ Les décharges électrostatiques (ESD) peuvent endommager l'équipement et gêner les circuits électriques. Des dégâts d'ESD surviennent lorsque des composants électroniques sont mal manipulés et peuvent causer des pannes totales ou intermittentes. Suivez les procédures de prévention d'ESD lors du

retrait et du remplacement de composants.

- ▶ Portez un bracelet anti-ESD et veillez à ce qu'il soit bien au contact de la peau. Si aucun bracelet n'est disponible, reliez votre corps à la terre en touchant la partie métallique du châssis.
- ▶ Vérifiez régulièrement la valeur de résistance du bracelet antistatique, qui doit être comprise entre 1 et 10 mégohms (Mohms).

Mounting Installation Precautions

The following should be put into consideration for rack-mount or similar mounting installations:

- ▶ Do not install and/or operate this unit in any place that flammable objects are stored or used in.
- ▶ The installation of this product must be performed by trained specialists; otherwise, a non-specialist might create the risk of the system's falling to the ground or other damages.
- ▶ Lanner Electronics Inc. shall not be held liable for any losses resulting from insufficient strength for supporting the system or use of inappropriate installation components.
- ▶ Elevated Operating Ambient - If installed in a closed or multi-unit rack assembly, the operating ambient temperature of the rack environment may be greater than room ambient. Therefore, consideration should be given to installing the equipment in an environment compatible with the maximum ambient temperature (T_{ma}) specified by the manufacturer.
- ▶ Reduced Air Flow - Installation of the equipment in a rack should be such that the amount of airflow required for safe operation of the equipment is not compromised.
- ▶ Mechanical Loading - Mounting of the equipment in the rack should be such that a hazardous condition is not achieved due to uneven mechanical loading.
- ▶ Circuit Overloading - Consideration should be given to the connection of the equipment to the supply circuit and the effect that overloading of the circuits might have on overcurrent protection and supply wiring. Appropriate consideration of equipment nameplate ratings should be used when addressing this concern.
- ▶ Reliable Grounding - Reliable grounding of rack mounted equipment should be maintained. Particular attention should be given to supply connections other than direct connections to the branch circuit (e.g. use of power strips).

Electrical Safety Instructions

Before turning on the device, ground the grounding cable of the equipment. Proper grounding (grounding) is very important to protect the equipment against the harmful effects of external noise and to reduce the risk of electrocution in the event of a lightning strike. To uninstall the equipment, disconnect the ground wire after turning off the power. A ground wire is required and the part connecting the conductor must be greater than 4 mm² or 12 AWG.

Consignes de sécurité électrique

- ▶ Avant d'allumer l'appareil, reliez le câble de mise à la terre de l'équipement à la terre.
- ▶ Une bonne mise à la terre (connexion à la terre) est très importante pour protéger l'équipement contre les effets néfastes du bruit externe et réduire les risques d'électrocution en cas de foudre.
- ▶ Pour désinstaller l'équipement, débranchez le câble de mise à la terre après avoir éteint l'appareil.
- ▶ Un câble de mise à la terre est requis et la zone reliant les sections du conducteur doit faire plus de 4 mm² ou 12 AWG.

Grounding Procedure for DC Power Source

- ▶ Loosen the screw of the earthing point.
- ▶ Connect the grounding cable to the ground.
- ▶ The protection device for the DC power source must provide 30 A current.
- ▶ This protection device must be connected to the power source before DC power.

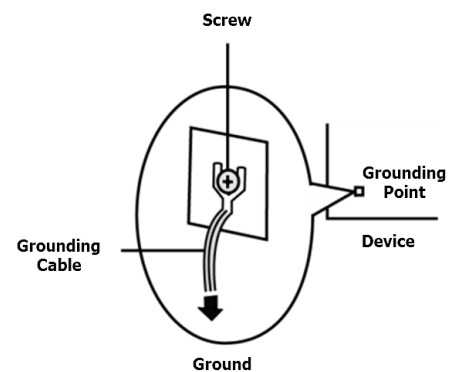

Procédure de mise à la terre pour source d'alimentation CC

- ▶ Desserrez la vis du terminal de mise à la terre.
- ▶ Branchez le câble de mise à la terre à la terre.
- ▶ L'appareil de protection pour la source d'alimentation CC doit fournir 30 A de courant.
- ▶ Cet appareil de protection doit être branché à la source d'alimentation avant l'alimentation CC.

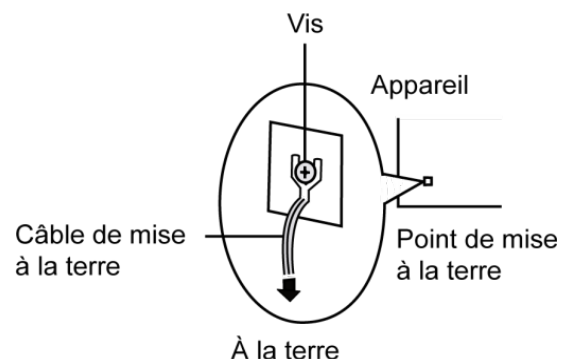



CAUTION: TO DISCONNECT POWER, REMOVE ALL POWER CORDS FROM UNIT.

注意：要断开电源，请将所有电源线从本机上拔下。

WARNUNG: Wenn Sie das Gerät zwecks Wartungsarbeiten vom Netz trennen müssen, müssen Sie beide Netzteile abnehmen.

ATTENTION: DÉBRANCHER LES TOUT CORDONS D'ALIMENTATION POUR DÉCONNECTER L'UNITÉ DU SECTEUR.

- ▶ This equipment must be grounded. The power cord for product should be connected to a socket-outlet with earthing connection.

Cet équipement doit être mis à la terre. La fiche d'alimentation doit être connectée à une prise de terre correctement câblée

- ▶ Suitable for installation in Information Technology Rooms in accordance with Article 645 of the National Electrical Code and NFPA 75.

Peut être installé dans des salles de matériel de traitement de l'information conformément à l'article 645 du National Electrical Code et à la NFPA 75.

- ▶ The machine can only be used in a restricted access location and has installation instructions by a skilled person.

Les matériels sont destinés à être installés dans des EMBLEMES À ACCÈS RESTREINT.

The product is only to be connected to PoE network without routing to outside plant.

Instruction for the installation of the conductor to building earth by a skilled person.

Table of Contents

Chapter 1: Product Overview	13
Main Features.....	13
Package Content.....	13
Optional Accessories	13
Ordering Information	14
System Specifications	15
Front Panel	16
Rear Panel.....	17
Motherboard Information.....	18
 Chapter 2: Hardware Setup	 29
Opening the Chassis	29
Installing the CPU	31
Installing the Disk Drive(s)	34
Installing the NIC Modules	36
Installing the System Memory.....	38
Replacing the Cooling Fans.....	41
Installing the AC Power Supply.....	42
Mounting the System	43
 Chapter 3: Software Setup	 49
Remote Server Management	49
Installing Operating System.....	58
BIOS Setup	59
 Appendix A: LED Indicator Explanations	 93

Appendix B: Dual BIOS Introduction 94

Why Dual BIOS? 94

Addressing BIOS Start-up Failure with Dual BIOS 95

Appendix C: Terms and Conditions 98

Warranty Policy 98

RMA Service..... 98

RMA Service Request Form 99

CHAPTER 1: PRODUCT OVERVIEW

The NCA-6110, a high-performance 2U rackmount network security appliance, is powered by the AMD EPYC™7000 Series CPU and offers support for 40Gbps encryption/decryption security acceleration, up to eight F.A.S.T. solution compatible NIC modules slots, 512GB DDR4 system memory, dual GbE RJ45 ports, 4x or 2x 3.5" or 2.5" swappable bays, 1x RJ45 console port and 2x PCIe*8 FHHL or 1x PCIe*16 FHFL.

Main Features

- ▶ AMD EPYC™ 7000 Series, Up to 32C64T CPU
- ▶ 16x 288-pin DIMM, Max. 512GB DDR4 2666MHz ECC R-DIMM
- ▶ 2x GbE RJ45 Intel® i210, Max. 8x NIC Module Slots
- ▶ Max. 4x 3.5" or 2.5" Swappable Bays, 1x RJ45 Console
- ▶ 2x PCIe*8 FHHL or 1x PCIe*16 FHFL

Package Content

Your package contains the following items:

- ▶ 1x NCA-6110 Network Security Platform
- ▶ 2x Power Cable (Default US Type)
- ▶ 1x Short Ear Rack mount kit with screws
- ▶ 1x Console cable (RJ45)
- ▶ 1x LAN Cable (RJ45)



Note

If you should find any components missing or damaged, please contact your dealer immediately for assistance.

Optional Accessories

Type	Description		
CPU	011W000359000	AMD	CPU X86 EPYC 7551 2.0GHz FCLGA 4094P AMD L3/64MB 180W
	011W000301000	AMD	CPU X86 EPYC 7501 2.0GHz LGA 4094P AMD 32-Core 155W
	011W000360000	AMD	CPU X86 EPYC 7451 2.30GHz FCLGA 4094P AMD L3/64MB 180W
	011W000316000	AMD	CPU X86 EPYC 7281 2.1GHz LGA 4094P AMD 16-Core L3/32MB 155W
RAM	020W000341000	ADATA	DIMM DDR4 AD4R2666316G19-BSSC 16GB 288P CL=19 PC4-21300 0.75ns A-DATA 2048Mx72 Samsung C-Die
	020W000340000	ADATA	DIMM DDR4 ECC+REG AD4R266638G19-BSSC 8GB 288P CL=19 PC4-21300 0.75ns A-DATA 1024Mx 72 Samsung C-Die
	020W000246000	INNODISK	DIMM DDR4 ECC+REG M4R0-BGS3GCIK-A90 32GB 288P CL=19 PC4-21300 0.75ns INNODISK 2Gx4

Rail Kit	098W000300014	Lanner	2U Slide Rail for Chassis Width: 438mm
Riser Card Kit	MSE5877-010	Lanner	62101A kit (Rear PCIE) 1*PCI-Ex16 Gen3, reserved 100W PSU input for supporting FHFL card
	PSF6819-010	Lanner	RC-62102A kit (Rear PCIE) 2*PCI-Ex8 Gen3, support 2x FHFL card, reserved power input connector to support 100W card
DC PSU	0P1W000089000 x2		DC 800W
IPMI card	PSE7129-002		IAC-AST2500B
	080W1K1205001		VGA cable (Rear) Internal VGA cable, 12P to 15P, Pitch=2.0mm 50CM,HO-BASE
TPM 2.0 module	PSE2811-111		IAC-TPM01C

It is strongly recommended to use Lanner Slim type NIC modules on this system; please consult Lanner for product compatibility if you consider adopting modules manufactured by other vendors.

Slim Type NIC Module					
Module	Ports	Connector Speed	Chipset	PCIe Interface	LAN Bypass
NCS2-IGM806A	8	1Gb RJ-45	Intel i350AM-4	2* PCIe4	G3
NCS2-ISM405A	4	1Gb SFP	Intel i350AM-4	1* PCIe4	Fiber Bypass Non-Latching
NCS2-ISM802A	8	1Gb SFP	Intel i350AM-4	2* PCIe4	N/A
NCS2-IMM802A	4+4	1Gb SFP 1Gb RJ-45	Intel i350AM-4	2*PCIEx4	G3
NCS2-IXM405A	4	10Gb SFP+	Intel 82599ES PEX8724	1* PCIe8	N/A
NCS2-IXM407A	4	10Gb SFP+	Intel XL710-BM1	1* PCIe8	N/A
NCS2-IQM201A	2	40Gb QSFP+	Intel XL710-BM2	1* PCIe8	N/A
NCS2-IXM801A	8	10Gb SFP+	Intel XL710-BM1	2*PCIEx4	N/A
NCS2-ISM406A	4	1Gb SFP	Intel i350AM-4	1* PCIe4	N/A
NCS2-IGM808A	8	1Gb RJ-45	PEX8618 Intel I210AT	1* PCIe8	G3
NCS2-IGM428A	4	1Gb RJ-45	Intel i350AM-4	1* PCIe4	G3
NCS2-IXM205A	2	10Gb SFP+	Intel 82599ES	1* PCIe8	Fiber Bypass Non-Latching Controller
NCS2-IXM409A	4	10Gb SFP+	Intel XL710-BM1	1* PCIe8	multi mode / latch

Ordering Information

SKU No.	Main Features
NCA-6110A	AMD EYPC 7000 Series, Up to 32C64T, 2x GbE RJ45, 4 x 2.5" or 3.5" SSD/HDD, 4x NIC Module Slots, 1 x RJ45 Console
NCA-6110B	AMD EYPC 7000 Series, Up to 32C64T, 2x GbE RJ45, 2 x 2.5" or 3.5" SSD/HDD, 8x NIC Module Slots, 1 x RJ45 Console

System Specifications

Form Factor		2U 19" Rackmount
Platform	Processor Options	AMD EPYC™ 7001/7002 64C128T
	CPU Socket	SP3
	Chipset	N/A
	Security Acceleration	40Gbps Encryption + 40Gbps Decryption
BIOS		AMI SPI Flash BIOS
System Memory	Technology	DDR4 2666 MHz REG DIMM
	Max. Capacity	512 GB
	Socket	16x 288pin DIMM
Networking	Ethernet Ports (By SKU)	1 x GbE RJ45 Intel® i210
	Bypass	N/A
	NIC Module Slot	8 or 4
LOM	IO Interface	1x RJ45
	OPMA slot	Yes
I/O Interface	Reset Button	1
	LED	Power/Status/Storage
	Power Button	1x ATX Power Switch
	Console	1x RJ45
	USB	2x USB 2.0
	LCD Module	N/A (Optional)
	Display	1 x VGA (Optional)
	Power input	AC Power Inlet on PSU
Storage	HDD/SSD Support	2 or 4 x 3.5" Swappable Bays
	Onboard Slots	1 x mSATA
Expansion	PCIe	2x PCIe*8 FH or 1x PCIe*16 FH
	mini-PCIe	N/A
Miscellaneous	Watchdog	Yes
	Internal RTC with Li Battery	Yes
	TPM	Yes (Optional)
Cooling	Processor	Passive CPU heat sink
	System	4 x Individual Hot-swappable Cooling Fans
Environmental Parameters	Temperature	0~40°C Operating -20~70°C Non-Operating
	Humidity (RH)	5~90% Operating 5~ 95% Non-Operating
System Dimensions	(WxDxH)	437 x 647 x 89 mm
	Weight	24 kg
Package Dimensions	(WxDxH)	825 x 600 x 270 mm
	Weight	26 kg
Power	Type/Watts	850W 1+1 ATX Redundant PSUs
	Input	AC 100~240V @47~63 Hz
Approvals and Compliance		RoHS, CE/FCC, UL

Front Panel

SKU A

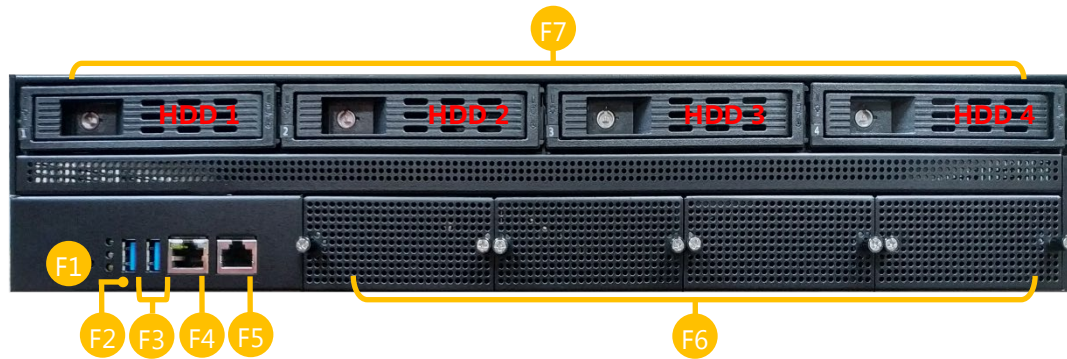

SKU B



No.	Description	
F1	Reset Button	<ul style="list-style-type: none"> - Press once for software reset - Press twice for hardware reset
F2	LED Indicators	 <ul style="list-style-type: none"> System Power System Status HDD Activity
F3	USB Ports	2x USB 3.0
F4	Management Port	1x RJ-45 Management Port (LOM) port
F5	Console Port	1x RJ-45 Console Port
F6	NCS2 Module	SKU A: 4 x STD NIC Module SKU B: 8 x STD NIC Module
F7	HDD Tray	SKU A: 4x 3.5"/2.5" HDD/SSD Tray SKU B: 2x 3.5"/2.5" HDD/SSD Tray

Rear Panel

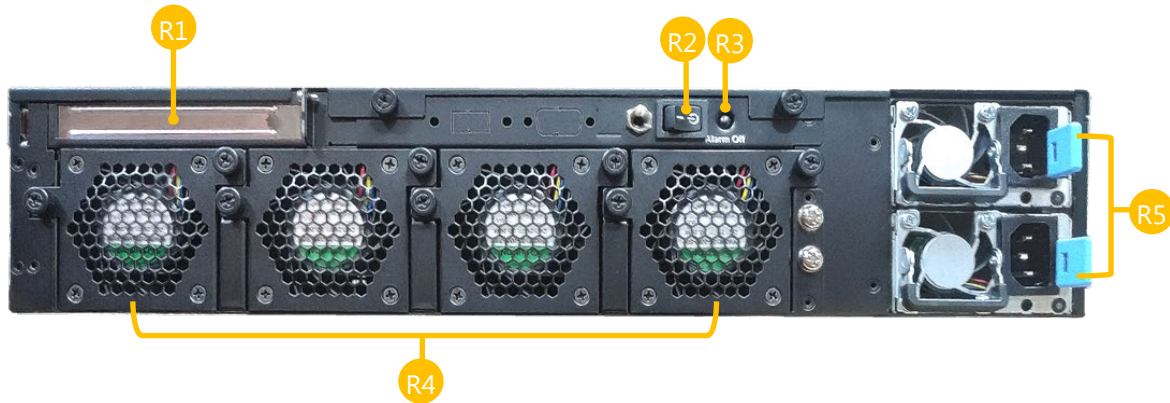

No.	Description	
R1	Rear PCIe Expansion	1 x PCIe expansion slot (Optional)
R2	Power Switch	1 x Power Button - Short press to power off the system; - Long press (> 4sec) to force the system to shut down - Short press twice to have GPIO select NMI EVENT
R3	Alarm off Button	An audible alarm will sound when the system's redundant power is missing. Press this button to turn the alarm off.
R4	Fans	4 x Independent Swappable Fans
R5	Power Supply	2 x 850W Redundant (N+1 Design)

Motherboard Information

Block Diagram

The block diagram indicates how data flows among components on the motherboard. Please refer to the following figure for your motherboard's layout design.

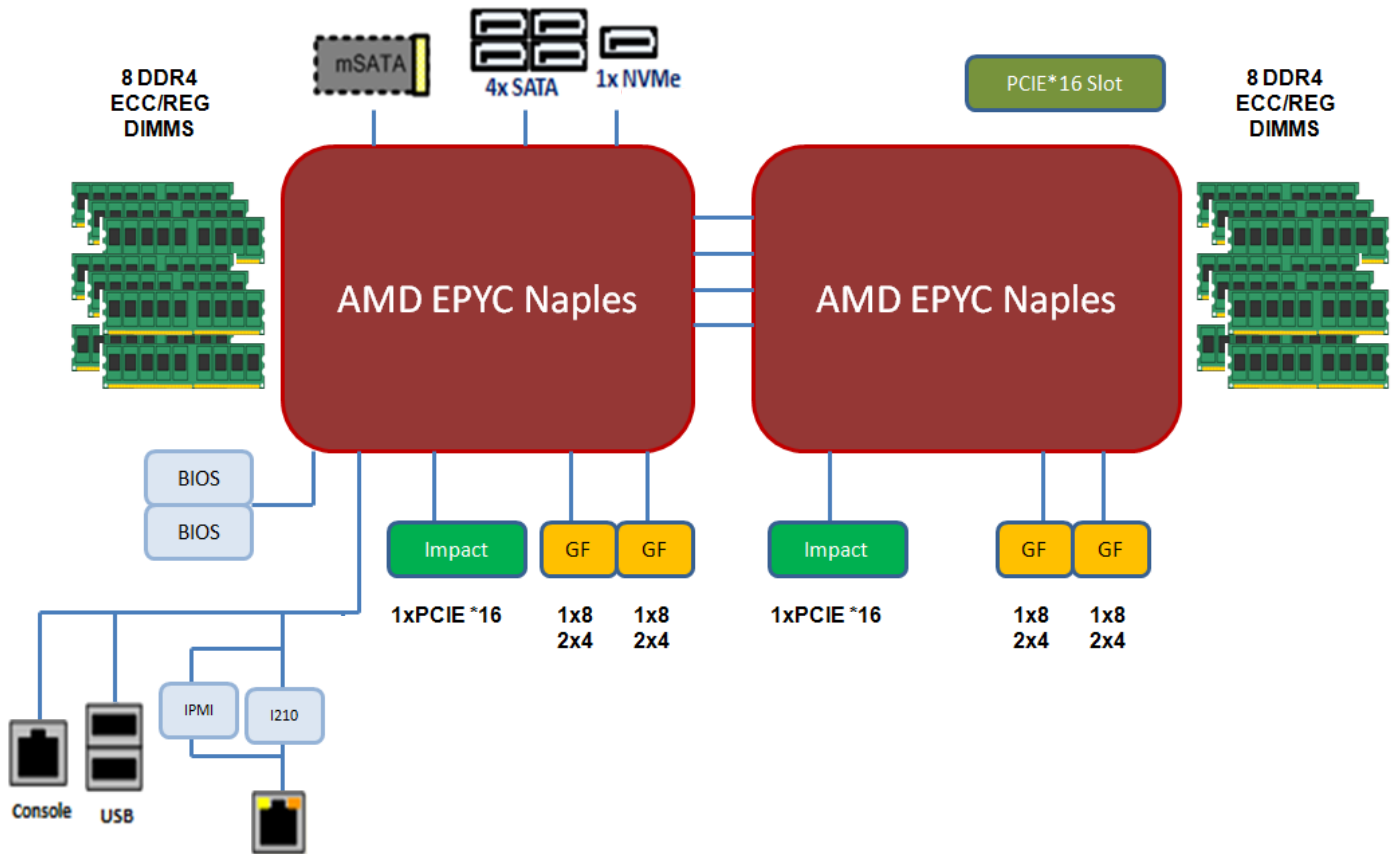

Motherboard Layout

The motherboard layout shows the connectors and jumpers on the board. Refer to the following picture as a reference of the pin assignments and the internal connectors.

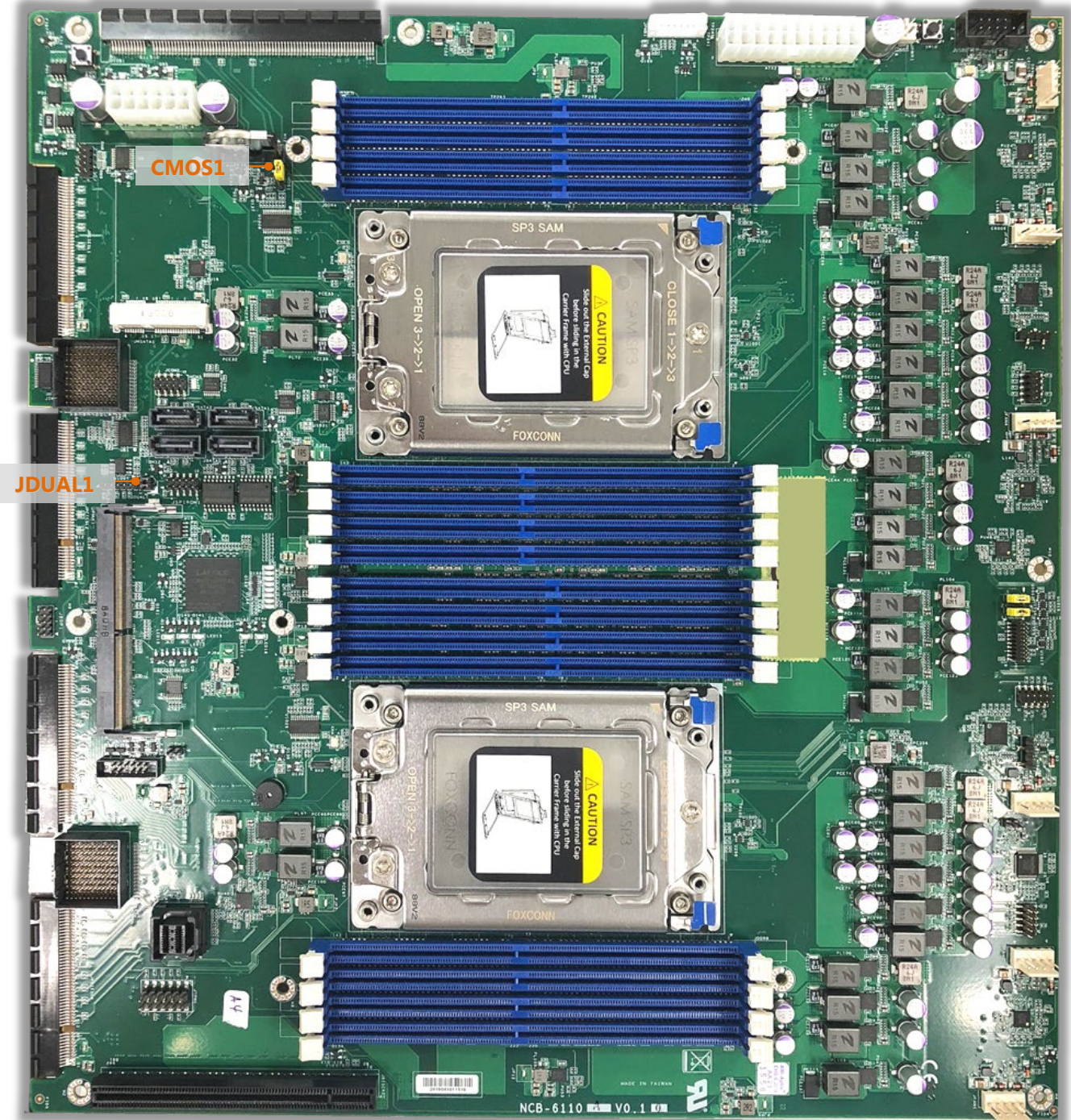





Internal Jumpers

The pin headers on the motherboard are often associated with important functions. With the shunt (Jumper) pushed down on the designated pins (the pin numbers are printed on the circuit board, surrounding the pin header), certain feature can be enabled or disabled. While changing the jumpers, make sure your system is turned off.

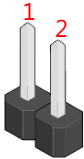
Jumper Setting

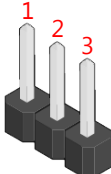
To short the designated pins, push the jumper down on them so that they become **SHORT**. To make the pins setting **OPEN**, simply remove the jumper cap.

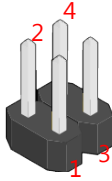
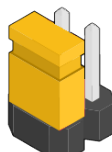
2-pin Header		3-pin Header		4-pin Header	
					
Open	Short	Open	(1-2) Jumped	Open	(1-2) Jumped

JDUAL1 : DUAL BIOS Switch

Configuration	Function
1-2 & 3-4	Flash 1 st BIOS(U2)(Default)
1-3 & 2-4	Flash 2nd BIOS(U3)



Pin	Description	Pin	Description
1	SPI_CS0#	2	SPI_CS0#_DUAL
3	SPI_CS1#_DUAL	4	SPI_CS1#

JCMOS1 : Clear CMOS

Pin	Description
1	VRTC
2	P0_VDDBT_RTC_G
3	GND



Function	Description
1-2	Normal
2-3	Clear CMOS

JOPEN1 : Enable / Disable CASE OPEN#

Pin	Description
1	FM_INTRUDER#
2	GND

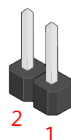

Internal Connectors

The IO board layout shows the connectors and jumpers on the board. Refer to the below picture as a reference of the pin assignments and the internal connectors.

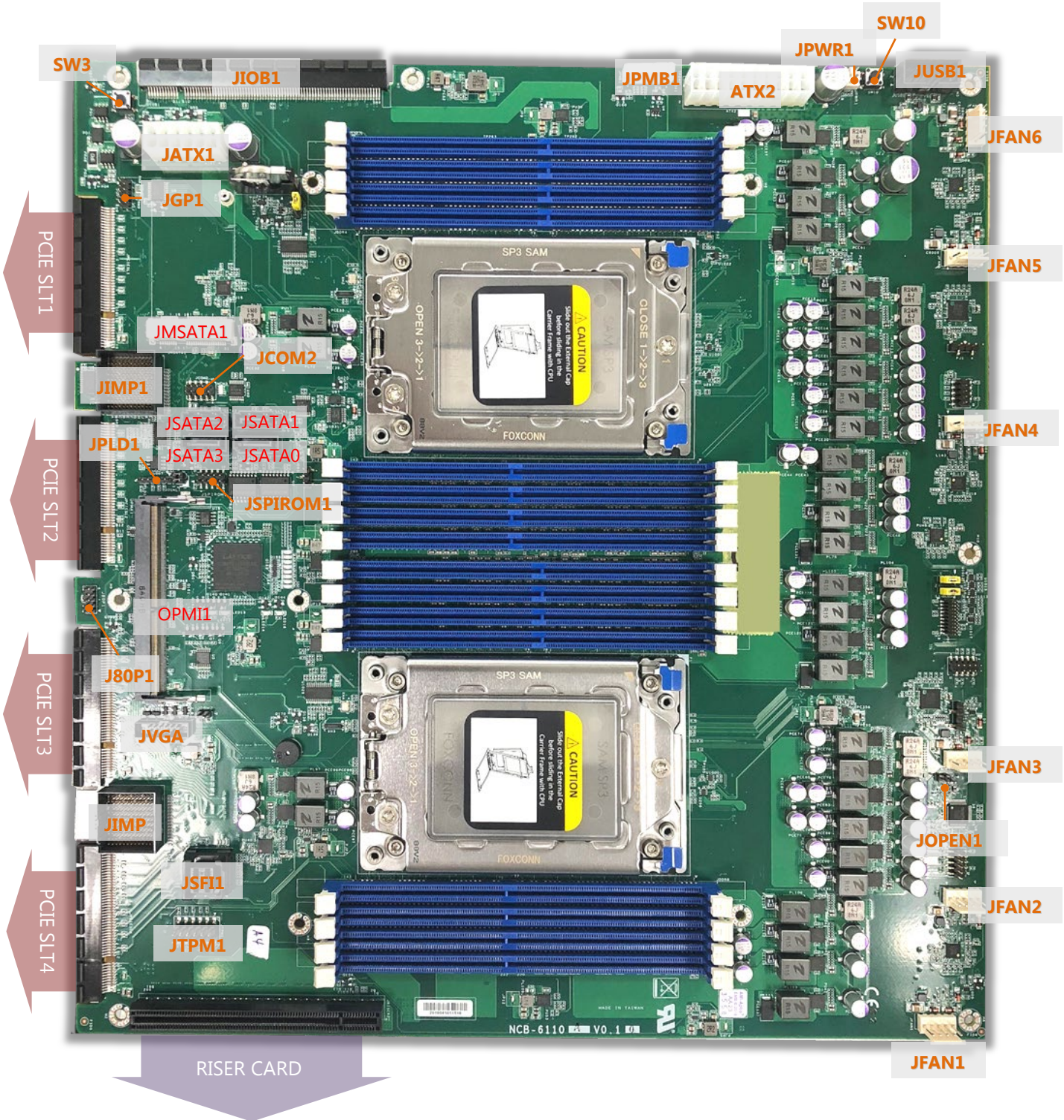

JPWR1 : Power Button Connector

PIN	Description
1	GND
2	PWRON#

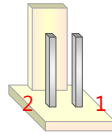

JVGA1

PIN	Description	PIN	Description
1	DAC_RO	2	GND
3	DAC_GO	4	GND
5	DAC_BO	6	GND
7	HSYNC_O	8	--
9	VSYNC_O	10	GND
11	DDC_DATA	12	DDC_CLK

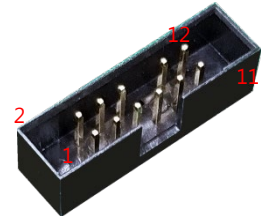

J80P1 : 80 Port connector

PIN	Description	PIN	Description
1	CLK_24M_DB	2	LPC_LAD1
3	PLT_RST#	4	LPC_LAD0
5	LPC_LFRAME#	6	+P3V3
7	LPC_LAD3	8	NC
9	LPC_LAD2	10	GND

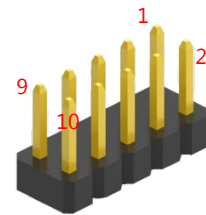

SW10 : Power Button

PIN	Description	PIN	Description
1	GND	2	GND
3	PWRON#	4	PWRON#

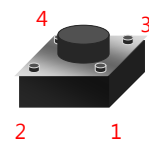

Function	Description
Short press >1 Sec	Normal shutdown/power-on
Long press 4 Sec	Forced shutdown
Press twice. The interval between the two short presses should not exceed 0.4 Sec	NMI event

SW3 : Reset Button

PIN	Description	PIN	Description
1	GND	2	GND
3	FP_RST#	4	FP_RST#

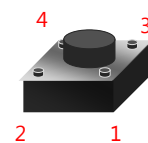

Function	Description
Short press >1 Sec	Software Reset
Press twice. The interval between the two short presses should not exceed 0.4 Sec	Hardware Reset

JPMB1 : PMBUS Connector

PIN	Description	PIN	Description
1	--	2	--
3	ATX_PSON#	4	GND
5	ATXPWGD	6	PMBUS_CLK
7	PMBUS_DAT	8	PMBUS_ALERT#

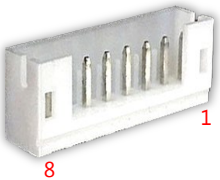

ATX1: 12 Pin Power Connector

PIN	Description	PIN	Description
1	GND	2	P12V
3	GND	4	P12V
5	GND	6	P5V
7	GND	8	P3V3
9	GND	10	P3V3
11	GND	12	P12V_SB

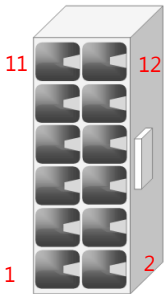

ATX2: 20 pin Power Connector

PIN	Description	PIN	Description
1	GND	2	P3V3
3	GND	4	GND
5	GND	6	GND
7	GND	8	GND
9	GND	10	GND
11	P12V	12	P12V
13	P12V	14	P12V
15	P12V	16	P12V
17	P12V	18	P12V
19	P12V	20	P12V

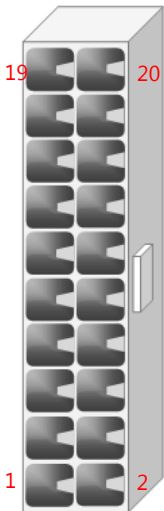

JSATA 0-3 : SATA connector

PIN	Description
1	GND
2	TX_P
3	TX_N
4	GND



5	RX_N
6	RX_P
7	GND

JTPM1 : TPM connector

PIN	Description	PIN	Description
1	P0_SERIRQ	2	P0_LFRAME_L
3	P0_LAD0	4	TPM_LPCCLK
5	P0_LAD1	6	+ P3V3_SB
7	P0_LAD2	8	NC
9	P0_LAD3	10	+P3V3
11	TPM_RST#	12	GND

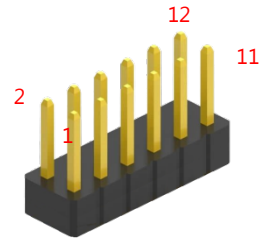

JSPIROM1 : SPI ROM programming connector to flash BIOS

PIN	Description	PIN	Description
1	SPI_HD1#	2	SPI_CS1#_DUAL
3	SPI_CS0#_DUAL	4	+P3V3_SPI_ME
5	SPI_MISO	6	SPI_PCH_IO3
7	NC	8	SPI_CLK
9	GND	10	SPI_MOSI

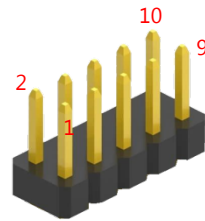

JUSB1 : USB 2.0 Port Connector

PIN	Description	PIN	Description
1	+P5V_USB1	2	--
3	USB20_N3_L	4	--
5	USB20_P3_L	6	--
7	GND USBGND1	8	--
9	NC	10	--

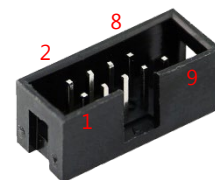

JFAN1 -6 : FAN connector

PIN	Description
1	Ground
2	12V
3	RPM Sense
4	RPM Sense
5	PWM Status



JGP1: EXT GPIO header

PIN	Description	PIN	Description
1	GPO_B_1	2	GPI_B_1
3	GPO_B_2	4	GPI_B_2
5	GPO_B_3	6	GPI_B_3
7	GPO_B_4	8	GPI_B_4
9	GND	10	GND

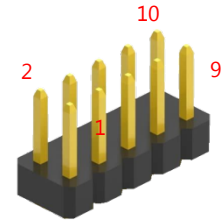

JCOM2 : Serials port pin header

PIN	Description	PIN	Description
1	--	2	--
3	BMC_COM2_RX	4	BMC_COM2_RTS
5	BMC_COM2_TX	6	BMC_COM2_CTS#
7	--	8	--
9	IO_GND2	10	--

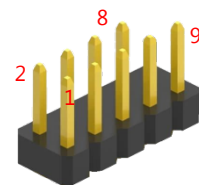

JIOB : IO HI-Speed BUS connector to connect IO-61101

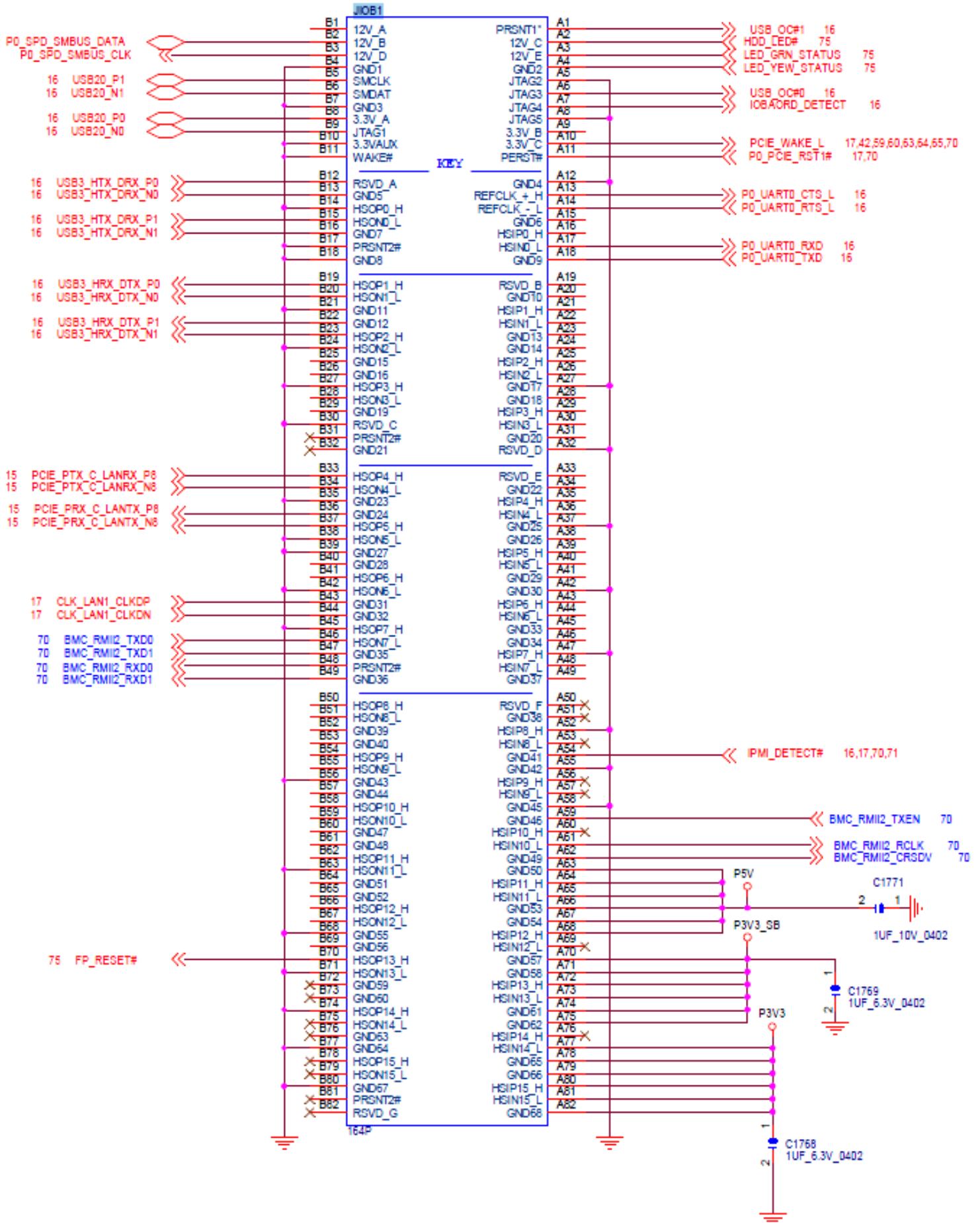

JRISER2

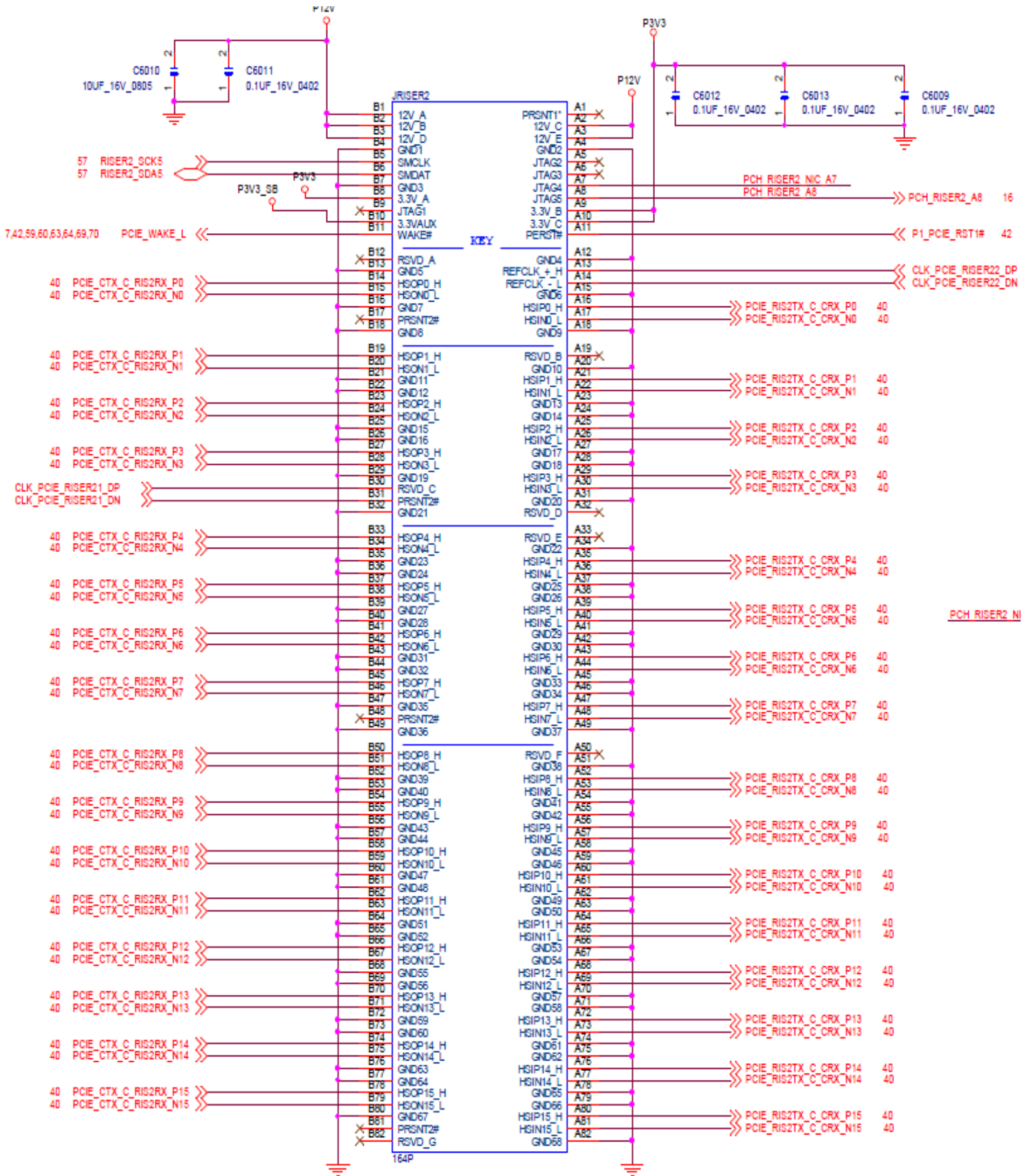

MSATA: for B Key M.2 storage

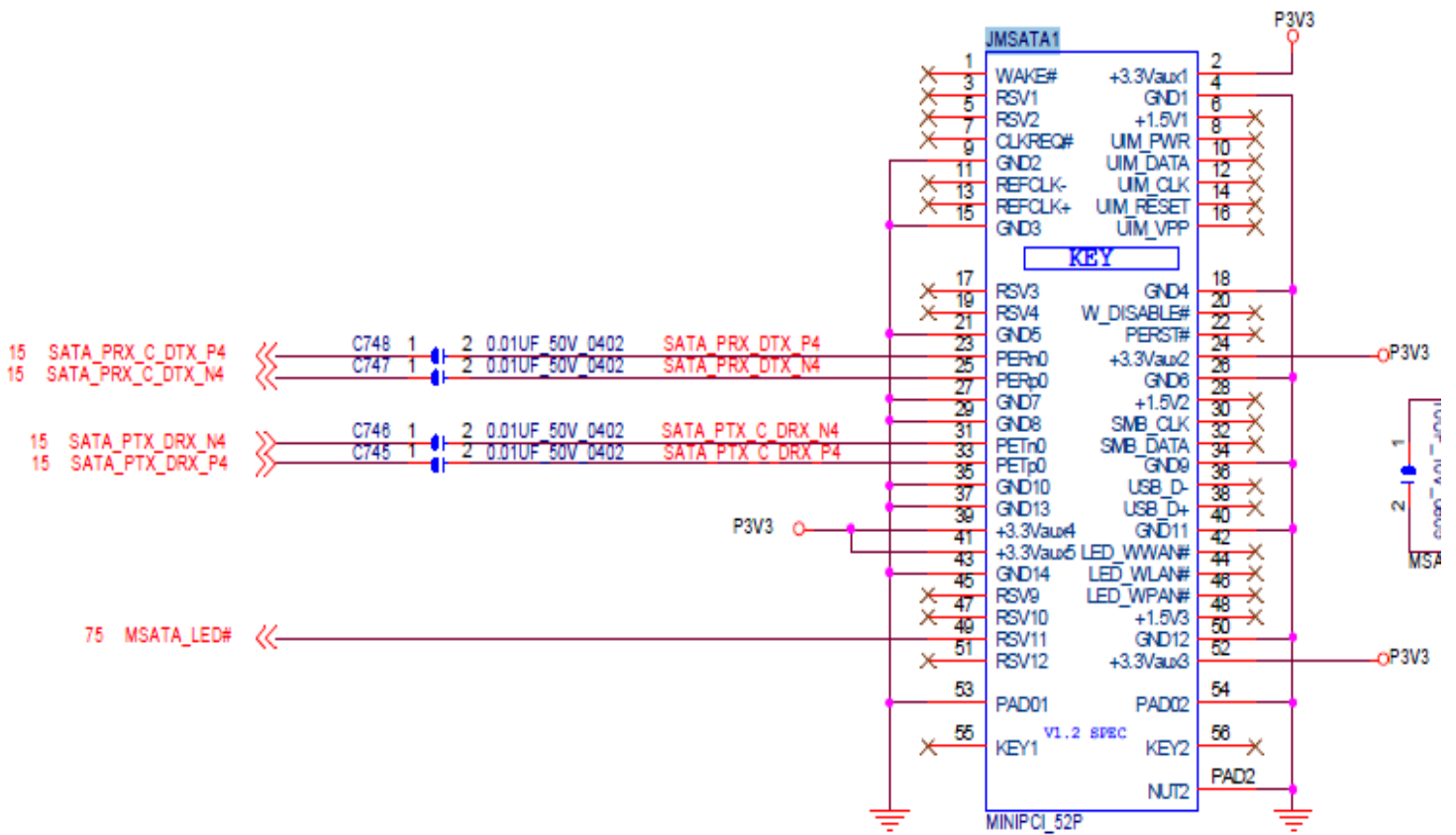

CHAPTER 2: HARDWARE SETUP

To reduce the risk of personal injury, electric shock, or damage to the system, please remove all power connections to shut down the device completely. Also, please wear ESD protection gloves when conducting the steps in this chapter.

Opening the Chassis

1. Loosen the 2 thumb screws on the rear panel.
2. Gently pull the top cover backward a bit, and lift the cover up to remove it.
3. Remove the cover that encloses the CPUs and the fans.

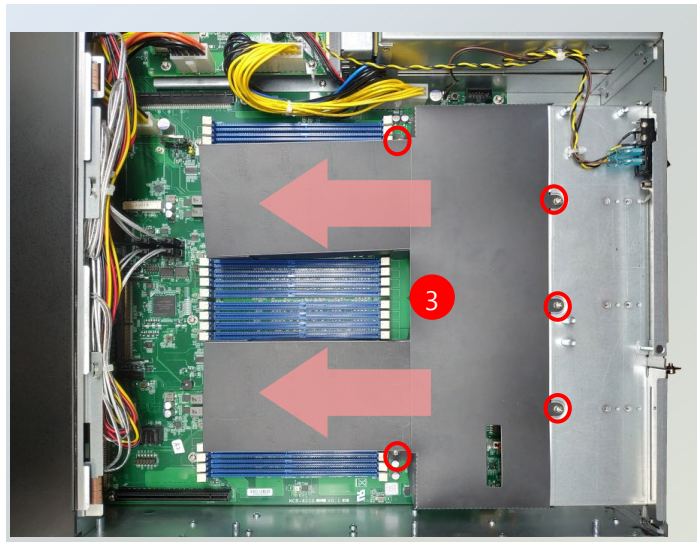
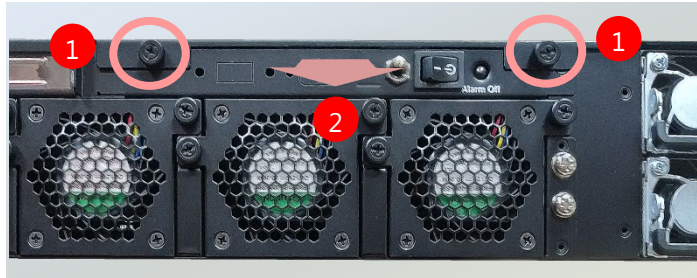

Based on your application and modules used, install modules in the corresponding slots.

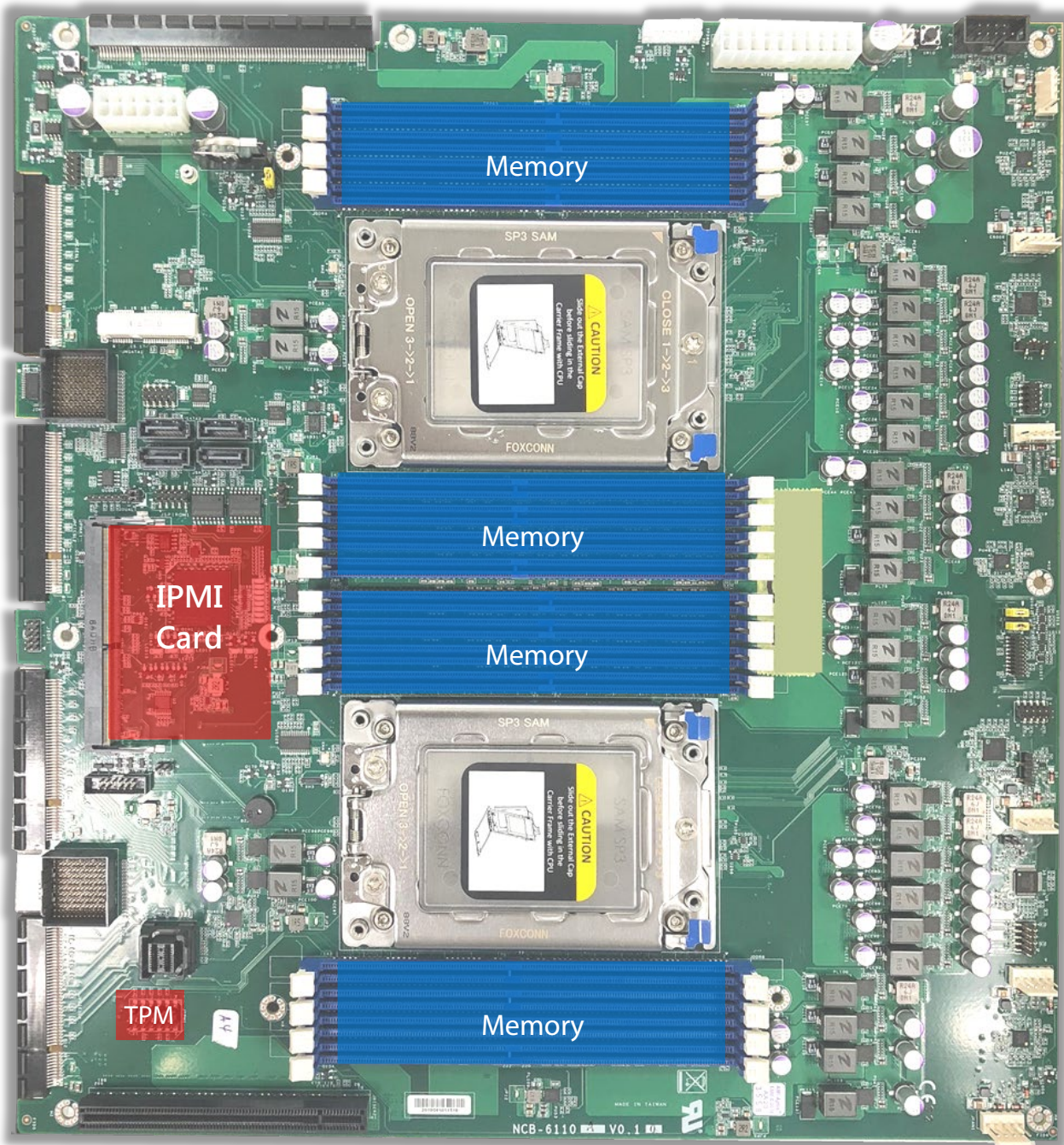



Installing the CPU

Please note that the system delivered to you comes with rather sophisticated design; therefore, the assembly of which must be handled with exclusive tools and extreme care by professionals. It is strongly recommended that you not make any adjustments to, remove or even re-install the processor on your own. If handling the processor on your own is inevitable, please read through the instructions in this section to make sure you have acquired the necessary knowledge and comply with the requirements.

Installing the processor onto motherboard involves two stages:

1. Remove the protective plastic cap.
2. Install the processor.
3. Install the Heatsink onto the motherboard.

Tools Required

Tool	Description
Torque screwdriver (Star T20)	For opening/closing the CPU sockets. 
ESD Protection (ESD gloves, ESD-safe work surface, etc.)	During the entire assembly process, at least wear a pair of ESD gloves to avoid damaging or contaminating the electronic parts while enhancing your own safety. 



Note

The images of tools shown in this document are merely for reference; the actual tools you use might differ.

Mounting the CPU onto the Heat Sink

1. Loosen the screws that secure metal frame in the sequence of **#3**→**#2**→**#1** using the T20 torque.

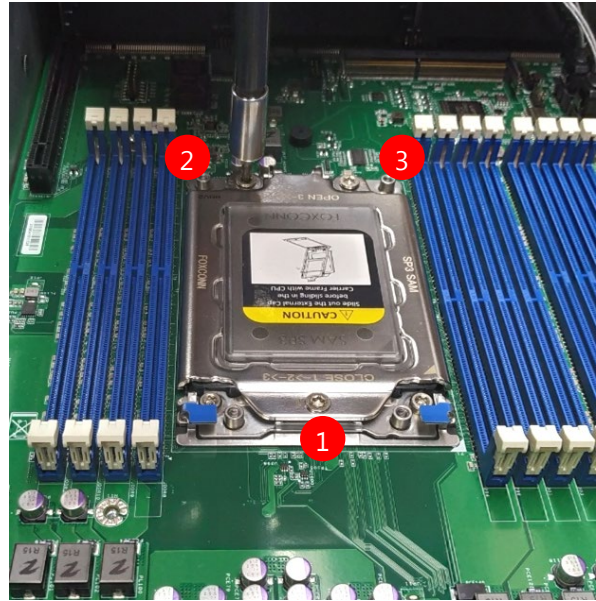

Once **#1** screw is loosened, the metal frame will pop up by itself.

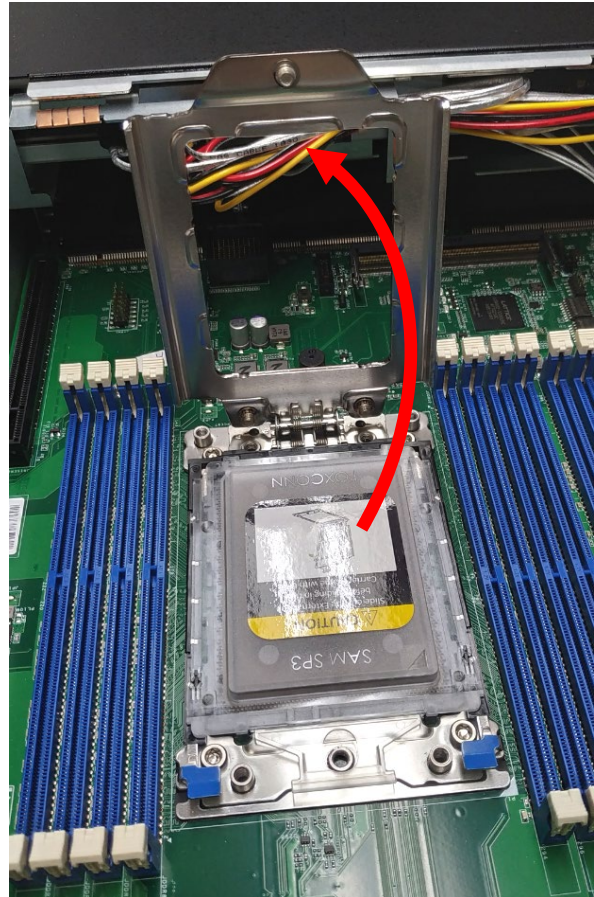

Gently lift the inner frame by the blue tab, and pull out the protective cap.

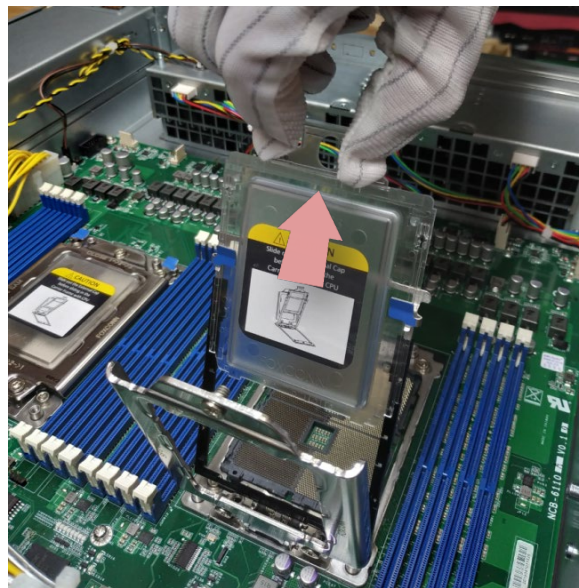

2. Carefully insert the CPU. Make sure the alignment corner marked on the CPU matches that of the metal frame. When securing the metal frame, fasten the screws in the sequence of #1→#2→#3.

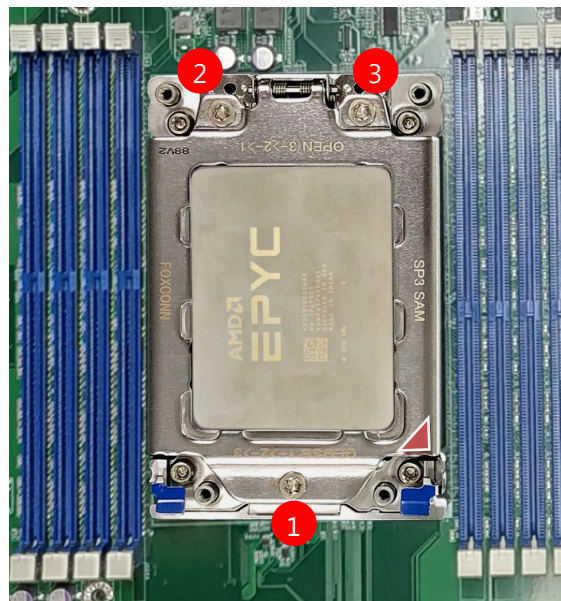

Installing the Disk Drive(s)

This system is built with drive bays that can accommodate 2.5 or 3.5 HDD/SSD. The following will discuss disk drive installation procedures based on their HDD/SSD designs.



1. Power off the system. Locate the disk bay on the front panel.

2. To remove the tray, put your finger on the tab and pull it open, hold the tab and then pull out the tray.

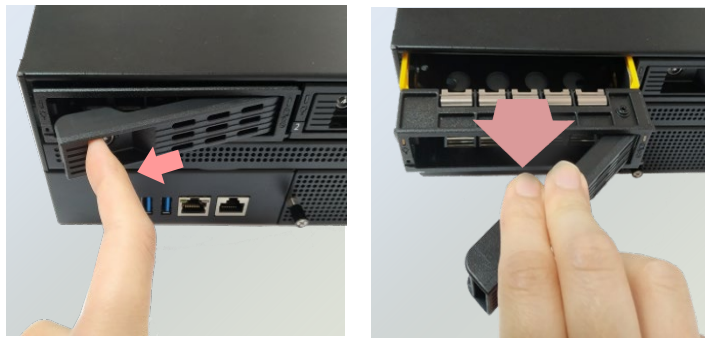

3. The tray is designed to accommodate one 3.5" hard disk or one 2.5" hard disk.

[Mounting a 3.5" hard disk](#)

Secure the hard disk on the tray with 4~6x #6-32 disk screws. Make sure the SATA contacts of the disk face towards the SATA connector inside the system.



Mounting a 2.5" hard disk

Secure the hard disk on the tray with 3x M3 disk screws. Make sure the SATA contacts of the disk face towards the SATA connector inside the system.

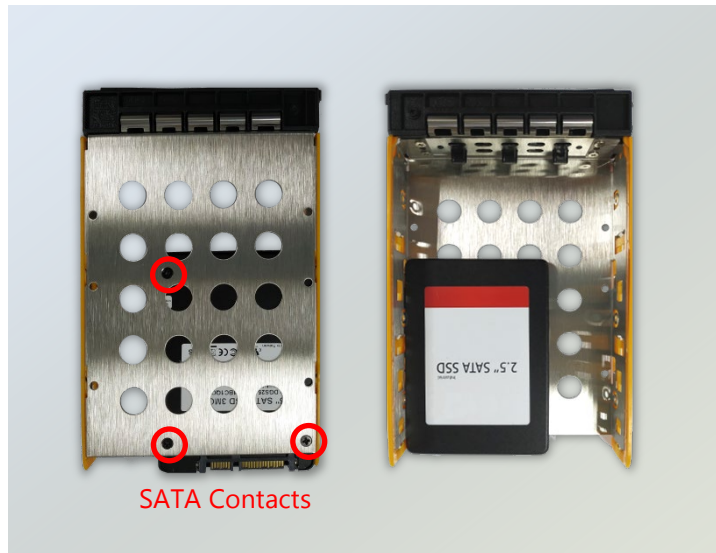

- 4. To install the mounted disk tray, push the tray into position in the chassis.

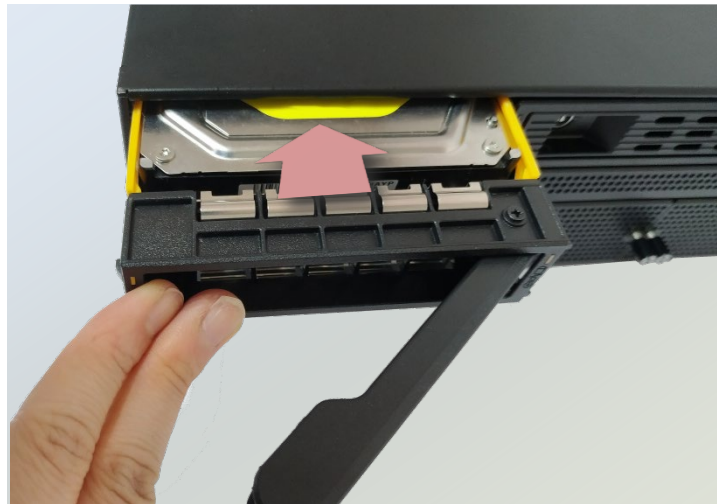

Close the hinge tab.



Installing the NIC Modules

This system comes with NIC Ethernet module slots for network bandwidth expansion. Please follow the steps for installation.

1. On the front panel, select a NIC Ethernet module slot.



2. Rotate clockwise and loosen the two lock-screws.



3. Remove the door and locate the PCIe socket for module insertion.

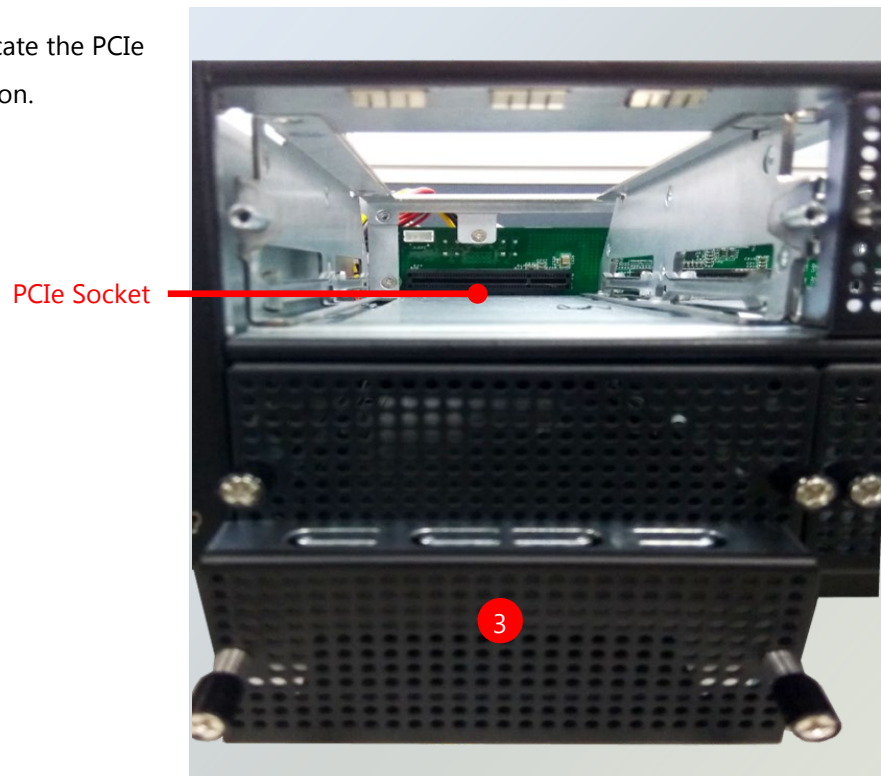

4. Insert your NIC Ethernet module.
(The module shown in the image below is for reference only).

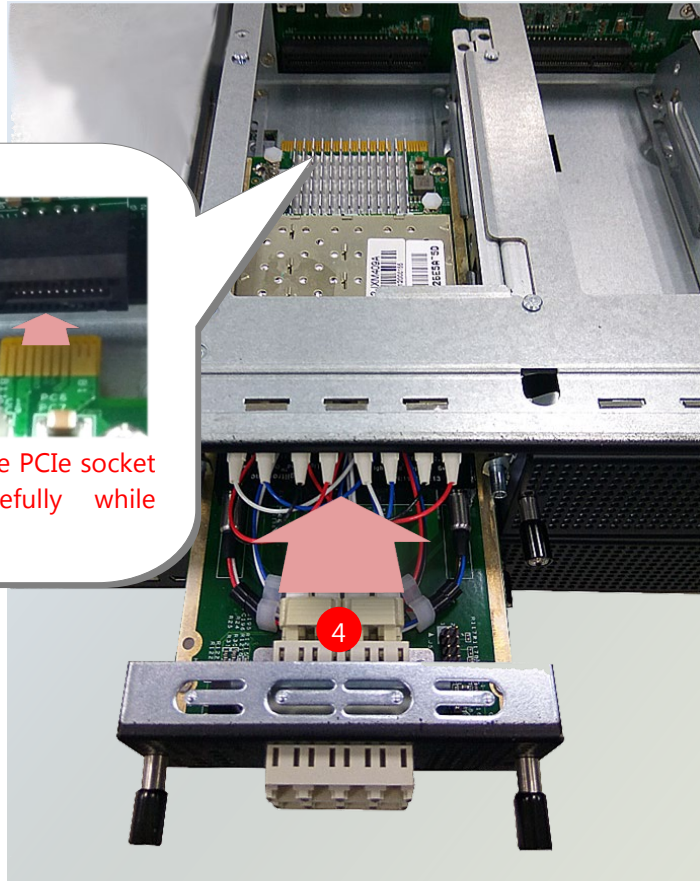
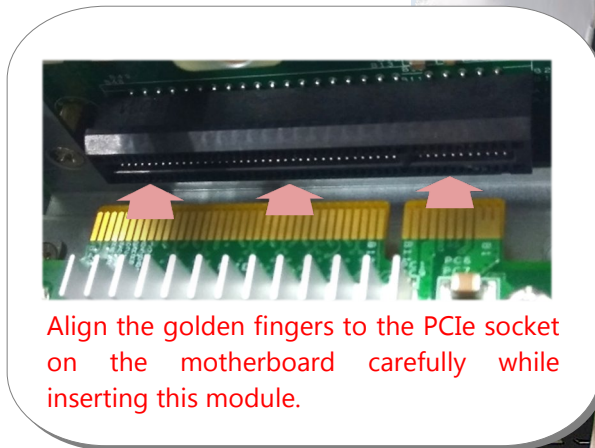

5. Once the module is firmly seated, rotate counter-clockwise and tighten the two lock-screws.



Installing the System Memory

The motherboard supports 16 memory slots for DDR4 registered DIMM.

Supported System Memory Summary

Total Slots	16 (8 slots per processor)
Number of Channels	8 (Channel 0~7, 1 DIMM per channel) per processor
Supported DIMM Capacity	4GB, 8GB, 16GB, 32GB
Memory Size	Maximum 512 GB RDIMM (32GB*16)
Memory Type	DDR4 1.2 V ECC RDIMM 2666/2400/2133 MHZ
Minimum DIMM Installed	Each processor requires at least 4 memory modules to boot and run from.

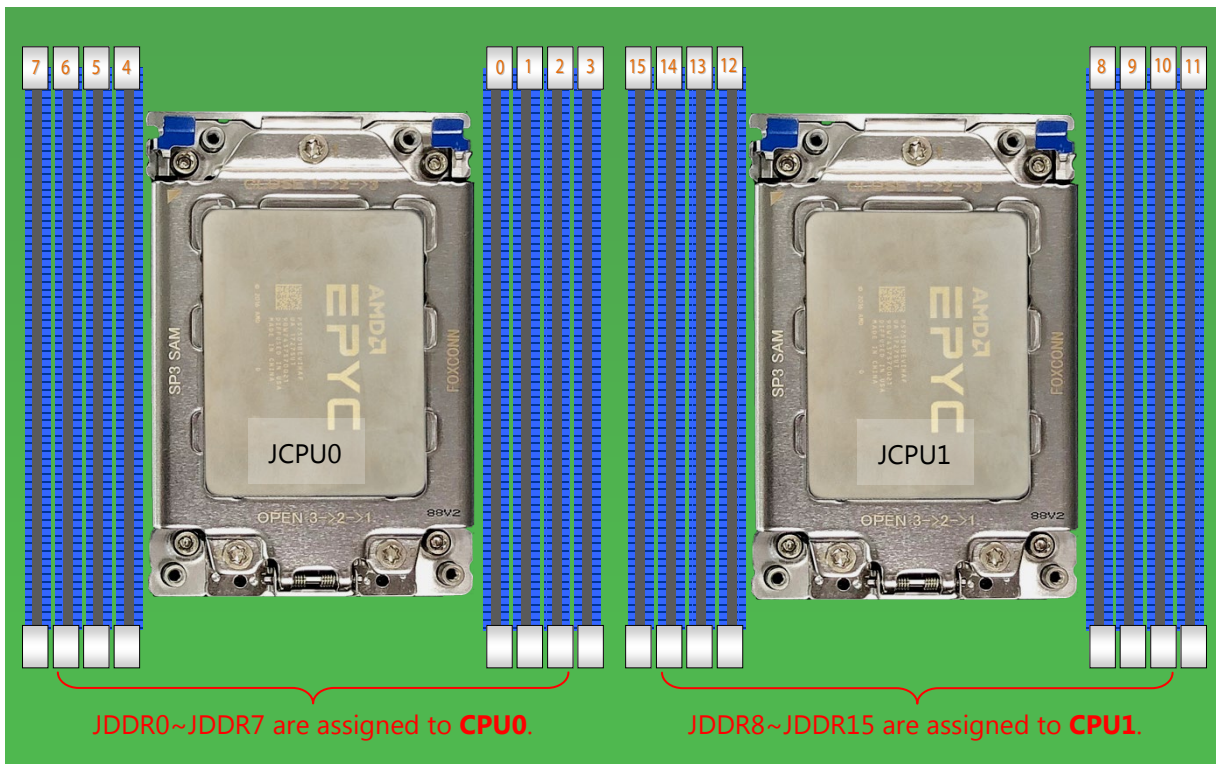

DIMM Population Guidelines

Please do follow the memory module installation instructions to install the DIMMs, and make sure

- Do not mix RDIMMs with LRDIMMs.
- For optimal performance, split the DIMMs evenly across the CPUs when two CPUs are installed.
- Using memory modules of the same capacity, speed and from the same manufacturer are highly recommended. However, with mixed module speeds, the overall speed will be that of the slowest installed memory module.

Recommended DIMM Population Scheme

The table below shows the recommended schemes for DIMM population. To guarantee balanced system performance, please install identical DIMMs of the same capacity, speed, number of ranks, and from the same manufacturer. As the recommended minimum requirement, each channel pair of a processor should have at least one DIMM installed.

Processor	CPU0								JCPU1								
	JDDR # (Channel)	7	6	5	4	0	1	2	3	15	14	13	12	8	9	10	11
Number of DIMMs Installed for 1 CPU	4 DIMMs		○		○	○		○									
	8 DIMMs	○	○	○	○	○	○	○	○								
Number of DIMMs Installed for 2 CPUs	8 DIMMs		○		○	○		○			○		○	○		○	
	16 DIMMs	○	○	○	○	○	○	○	○	○	○	○	○	○	○	○	○

Channel pair

DDR4 Memory Support vs. System Memory Speed

The table below lists the supported DDR4 types and the theoretical overall system memory speed. For optimal system speed, please install identical DIMMs of the same capacity, speed, number of ranks, and from the same manufacturer.

Type	DIMM Rank	Maximum DIMM Capacity (GB)		Maximum Frequency
		1 Channel	8 Channel	
RDIMM	SR	16GB	128GB	2666 MT/s
	DR	32GB	256GB	

Memory Module Installation Instructions

Please follow the steps below to install the DIMM memory modules.

1. Power off the system.
2. Pull open the DIMM slot latches.
3. Align the notch of the module with the socket key in the slot and carefully insert the card into the slot.

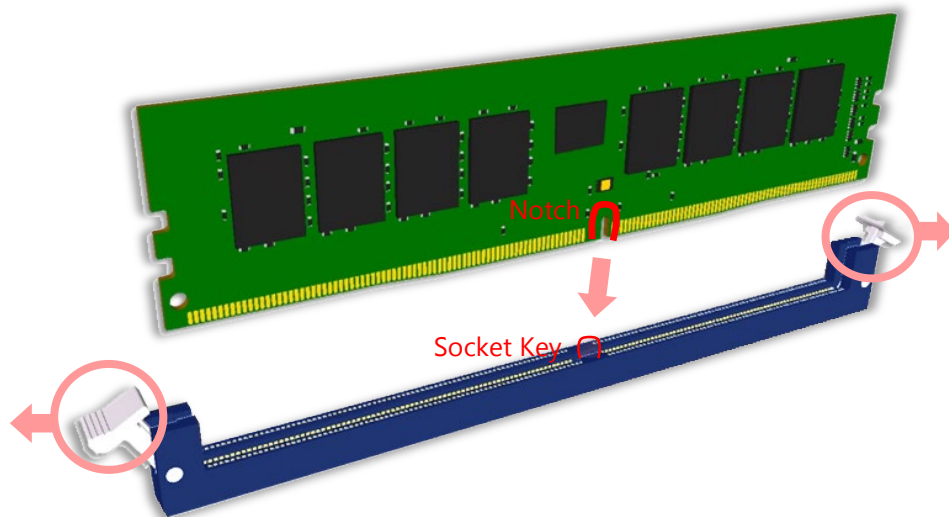

4. Push the module down into the slot until it is firmly seated. Press vertically on both corners of the card until it clicks into place.

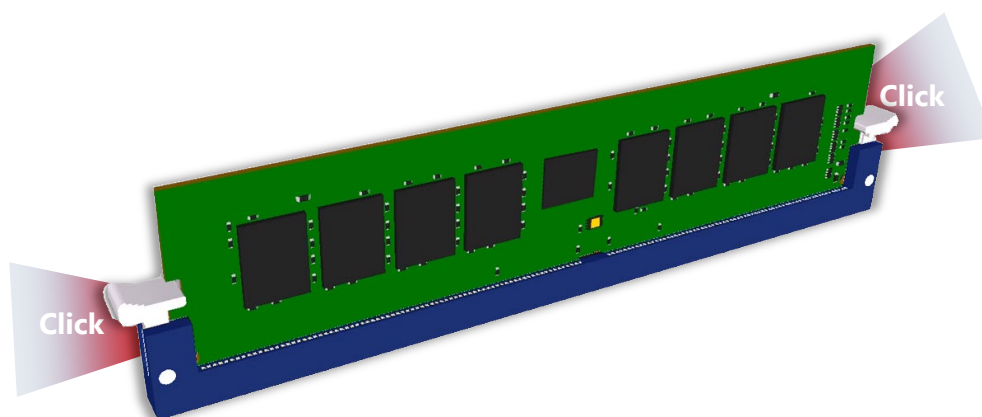

Replacing the Cooling Fans

Cooling fans may wear down eventually. Please refer to the steps below for replacing cooling fans. When using a new cooling fan, just reverse the steps to install the fan back onto the enclosure and the system.



1. On the rear panel, loosen the screws that secure the fan.
2. Take out the worn fan and disconnect its power cable connector from the motherboard.
3. Install a new fan by reversing the above steps.

Installing the AC Power Supply

Power supply units wear down eventually. Please be noted that this system supports only 850W PSU. Please prepare the power supply units matching this capacity.

1. On the rear panel, locate the power supply units and disconnect the power cords.
2. Pull the original unit out and replace it with a new one.

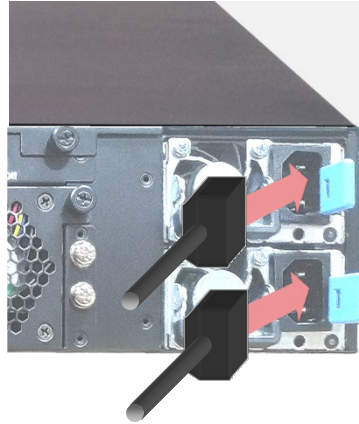

Mounting the System

There are various methods to mount this system based on your application and the environment. This system came with two types of mounting kits for a typical rack or enclosure mounting installation or installing this system in a rack:

► Ear Brackets

This method is quick and easy by fixing this system to the front posts of the rack while being the most unstable method, for the bracket assembly alone cannot provide sufficient support to the chassis. Please ensure the use of these brackets goes with a shelf or slide rails to prevent the chassis from falling over.

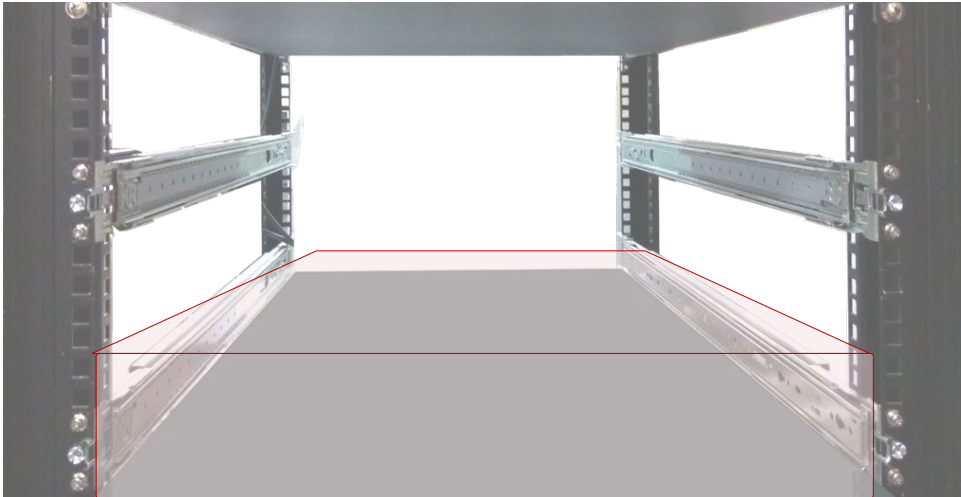

The system shall be installed on the rack along with a shelf or slide rails, for the "Mounting Ears" are meant to secure the system, not to support it.

► Slide Rail Kit + Short Ear Brackets

Although this method is rather complicated, the slidable rails allow you to access the system easily while securing it in the rack solidly.

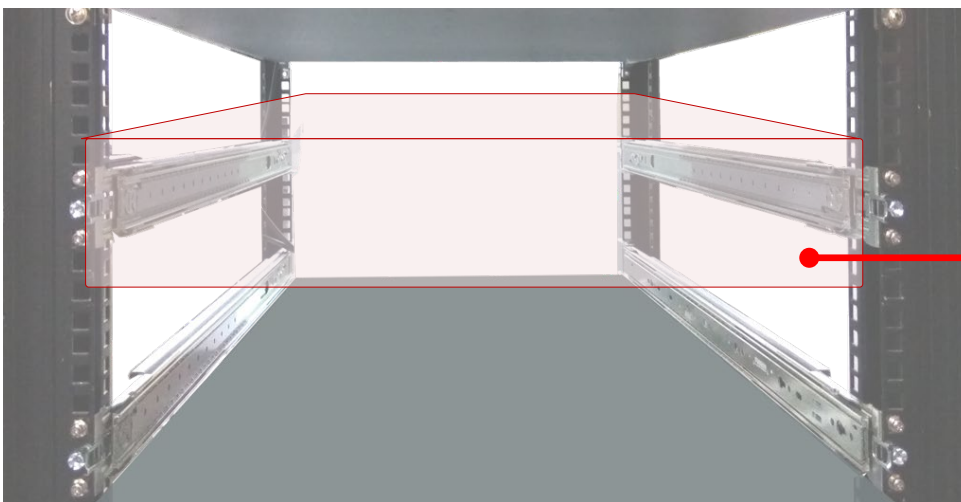

The Slide Rail Kit can secure the system while providing sufficient weight support for the device.

Installing the System Using Mounting Ear Bracket

1. Check the package contents. The mounting ear brackets shall include the items below:

- ▶ 1x Screw Pack

- ▶ 2x Ear Brackets

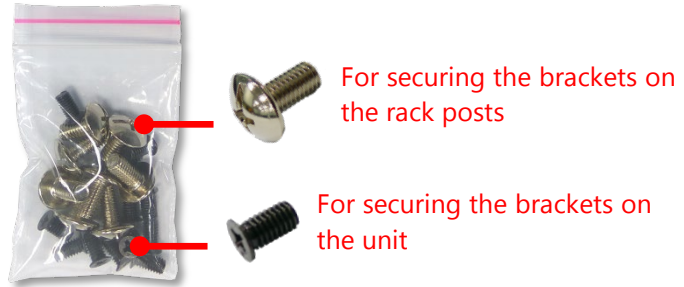

2. Secure the bracket onto one side of the chassis using six provided screws.

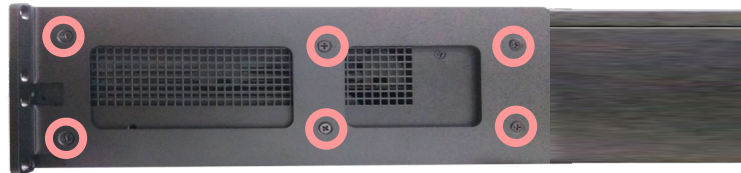

3. Secure the other bracket on the other side of the chassis.



4. Install the chassis into the rack with the brackets fixed onto the posts using the provided screws. The actual approach you take and the needed parts for assembly will depend on the supporting accessory (shelf or rail kit) you use.

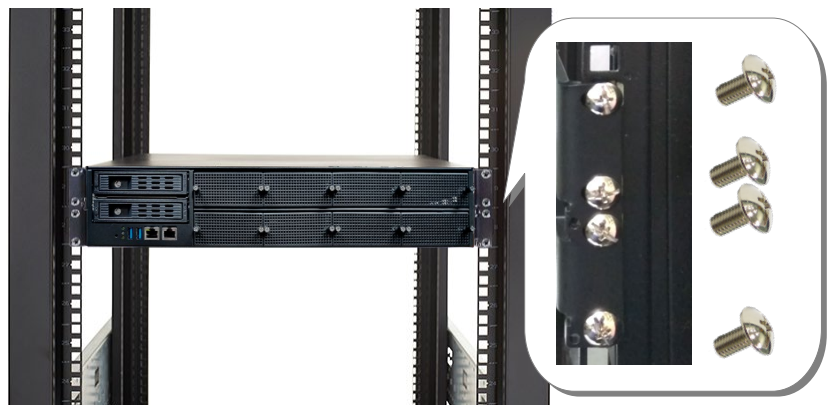

Installing the System Using the Slide Rail Kit (with Short Mounting Ear Brackets)

1. Check the package contents of the Slide Rail Kit. The kit shall include the following items:

- ▶ 1x pack of M4X4L screws (for securing the sliding rail on the system)
- ▶ 1x pack of 7.1 Round Hole screws (for securing the system on the rail posts)
- ▶ 2 x Slide Rails



The rail consists of the following parts:

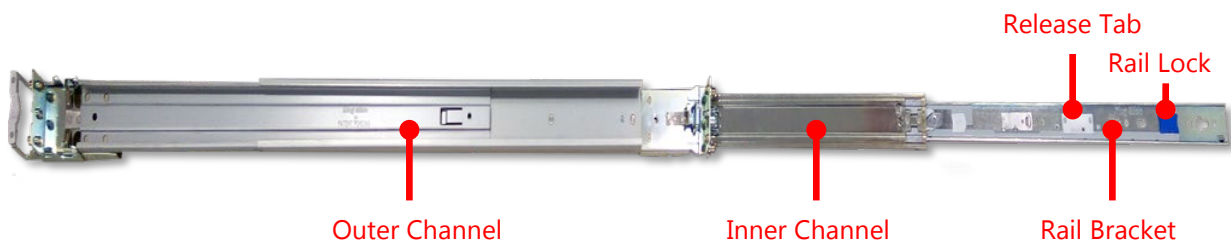

Attaching the Rail Brackets

2. Unpack a slide rail and slide the inner channel all the way to the end.
3. Stretch the bracket to the fullest.
4. Remove the bracket from the Inner Rail by pushing the Release Tab on the bracket outwards while sliding it out.

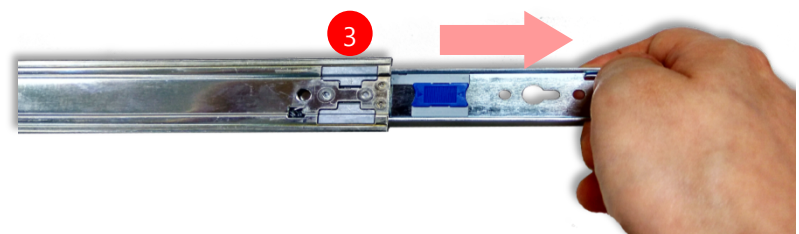
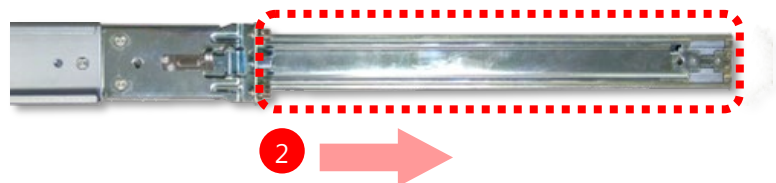

- Align the bracket to the side of the chassis and make sure the screw-holes are matched, and then secure the bracket onto the chassis with five provided M4X4L screws.

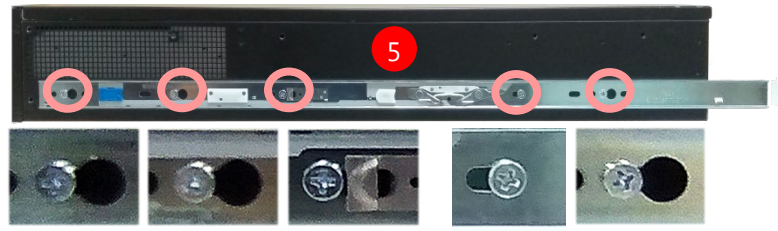

Align the screws with the indicated holes on the brackets as well as the screw holes on the side of the chassis.

- Repeat Step 2~5 to attach the bracket to the other side of the chassis.



Assembling the Ear Brackets

- Check the package contents. The supplied mounting kit shall include the items below:

- ▶ 1x pack of screws
- ▶ 2x Standard Ear Brackets

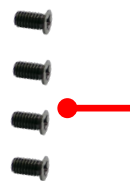

For securing the brackets on the unit



Left Ear Right Ear

- Install the brackets on both sides of the system using the provided screws.

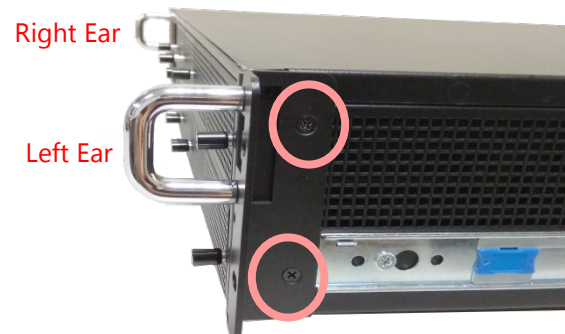

Installing the Slide Rails

Now, you shall install the slide rail assemblies onto the rack.

9. This slide-rail kit does NOT require screw-fixing. Simply aim at **3** available screw holes on the rack front and snap the rail front into the rack post as shown in the image below. You should hear a “click” sound once it is firmly attached.

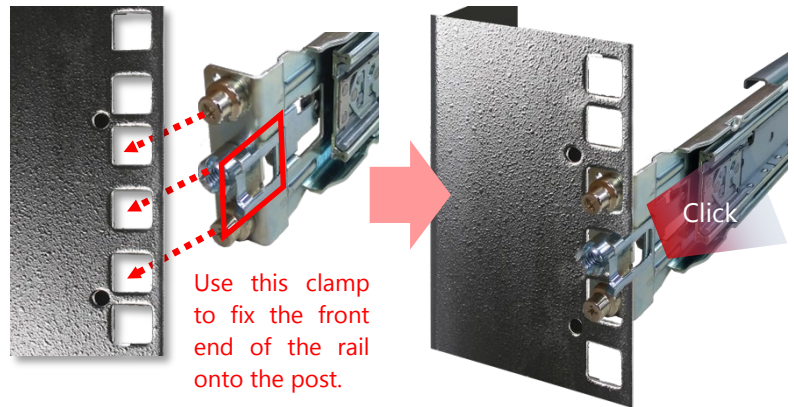

10. For the rear rack installation, slide the rail to aim and engage the bolts on the rail's rear end with the 2 available holes on the post, and the rail assembly will click into place.

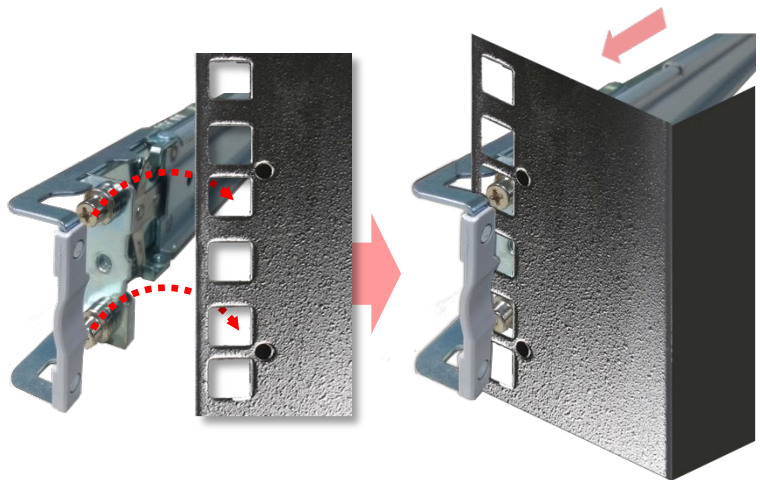

Installing the System into the Rack

11. Stretch both of the inner rails out to their fullest extent. You will hear a click sound when they are fully stretched and locked.

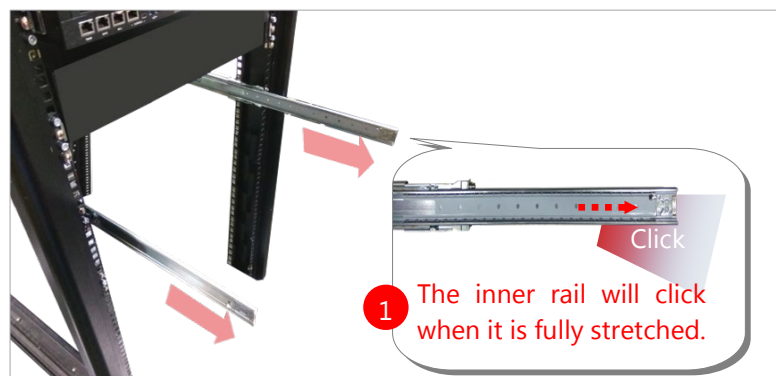

- 12.** Hold the system with its front facing you, lift the chassis and gently engage the brackets on the model while aligning them with the slide-rail assemblies as shown in the image below, and then push the system into the cabinet.

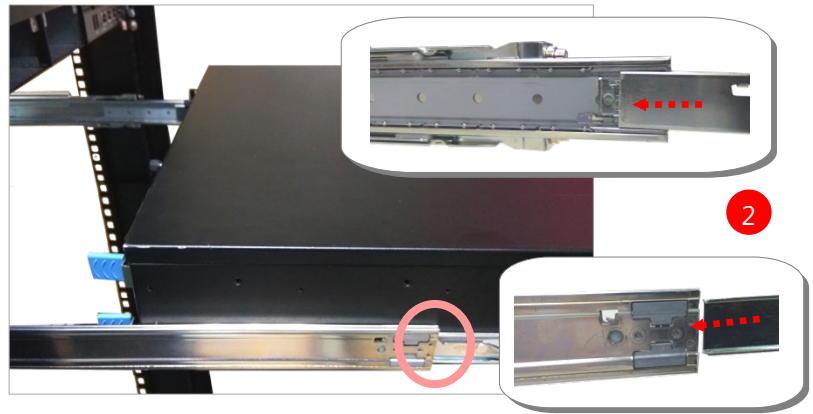

While pushing in the system, please also push and hold the Rail Lock tab on both brackets.

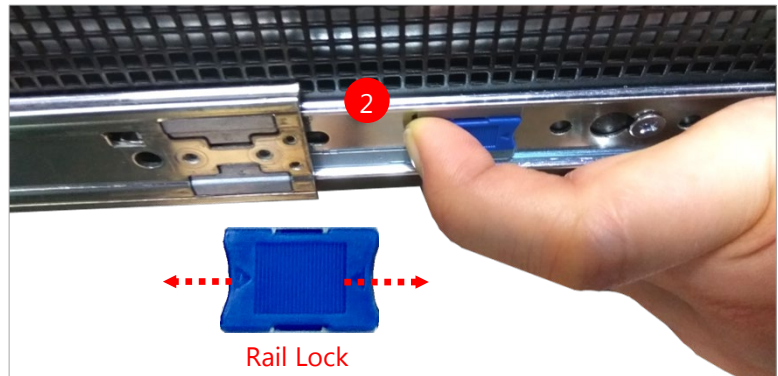

To remove the system from the rack, gently pull it outwards towards you while pushing the Release Tab on both sides of the brackets.

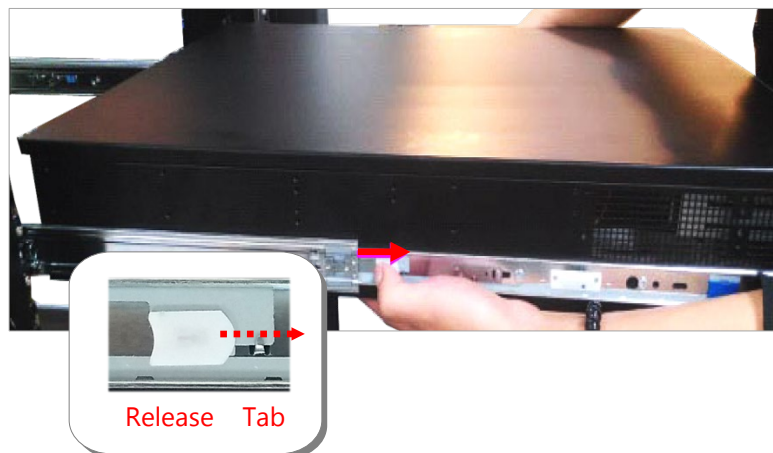

CHAPTER 3: SOFTWARE SETUP

Remote Server Management

Overview

This document specifies the BMC firmware features of Lanner. The BMC firmware implements IPMI 2.0 based on ASPEED service processor. It performs all the BMC management tasks defined by IPMI 2.0.

In addition, Lanner’s BMC firmware runs an embedded web-server for full configuration using Web UI, which has a low learning curve.

BMC Main Features

Feature		Description
IPMI 2.0 Standard Features	System Interface support	<ul style="list-style-type: none"> • KCS (System Interface Support) • LAN (RMCP+) • BMC stack with an IPMI 2.0 implementation • Sensor monitoring • System power management • Watchdog timer • Fan speed monitor and control • FRU information • System Event Log (SEL) • Support in IPMI stack for SOL to remotely access BIOS and text console before OS booting • IPMI based user management • Multiple user permission level
	IPMI 2.0 based Management	
	System Management	
	Event Log	
	Text Console Redirection: SOL	
	User Management	
Non-IPMI functions	Web User Interfaces	<ul style="list-style-type: none"> • BMC management via web user interface • Integrated KVM and Virtual Media • RADIUS support • LDAP support
	User authorization	
	Security	<ul style="list-style-type: none"> • SSL and HTTPS support • Auto-sync time with NTP server • Remote firmware update by Web UI or Linux tool
	Maintenance	

BMC Firmware Functional Description

System health monitoring

The BMC implements system sensor monitoring feature. It could monitor voltage, temperature, and current of critical components.

System Power Management

The BMC implements chassis power and resets functions for system administrators to control and manage the system power behavior. These functions can be activated by sending the IPMI 2.0 compatible chassis commands to the BMC over messaging interfaces. The following list summarizes the supported functions.

- Chassis power on
- Chassis power off
- Chassis power cycle
- Chassis power reset
- Chassis power soft
- Server's power status report

Watchdog Timer

The BMC provides an IPMI 2.0 compatible watchdog timer which can prevent the system from system hanging.

Fan Speed Control

BMC is in charge of fan speed control. The fan speed can be modified by varying the duty cycle of PWM signal. The fan speed control algorithm mainly refers to the readings of on-board temperature sensors.

Field Replaceable Unit (FRU)

The BMC implements an interface for logical FRU inventory devices as specified in IPMI 2.0 specification. This functionality provides commands for system administrators to access and management the FRU inventory information.

System Event Log (SEL)

A non-volatile storage space is allocated to store system events for system status tracking.

Serial over LAN (SOL)

IPMI 2.0 SOL is implemented to redirect the system serial controller traffic over an IPMI session. System administrators are able to establish a SOL connection with a standard IPMI client, like IPMITOOL, to remotely interact with serial text-based interfaces such as OS command-line and serial redirected BIOS interfaces.

User Management

The BMC supports 9 IDs for IPMI user accounts. The maximum length of the username and password are 16 and 20 respectively, and the possible privilege levels are Callback, User, Operator, and Administrator. Moreover, the account creator is allowed to enable/disable the user account at any time. If not specified, the default user accounts are listed follows:

User Name	Password	User Access	Characteristics
admin	admin	Enabled	Password can be changed

Keyboard, Video, Mouse (KVM) Redirection

- The BMC provides keyboard, video, and mouse (KVM) redirection over LAN. This application is available remotely from the embedded web server.
- Support video recording, recorded videos to be downloaded & playable.

Virtual Media Redirection

- The BMC provides remote virtual CD, HD and FD redirection. CD image could be mounted directly in KVM window. HD, FD could be mounted by NFS and SAMBA.
- Efficient USB 2.0 based CD/DVD redirection with a typical speed of 20XCD.
- Completely secured transmission.

IPMI Commands Support List

COMMANDS	NETFN	CMD
IPM Device “Global” Commands		
Get Device ID	APP (06h)	00h
Cold Reset	APP (06h)	02h
Warm Reset	APP (06h)	03h
Get Device GUID	APP (06h)	08h
BMC Watchdog Timer Commands		
Reset Watchdog Timer	APP (06h)	22h
Set Watchdog Timer	APP (06h)	24h
Get Watchdog Timer	APP (06h)	25h
BMC Device and Messaging Commands		
Get System GUID	APP (06h)	37h
Get Channel Info	APP (06h)	42h
Set User Access	APP (06h)	43h
Get User Access	APP (06h)	44h
Set User Name	APP (06h)	45h
Get User Name	APP (06h)	46h
Set User Password	APP (06h)	47h
Chassis Device Commands		
Get Chassis Capabilities	Chassis (00h)	00h
Get Chassis Status	Chassis (00h)	01h
Chassis Control	Chassis (00h)	02h
Chassis Reset	Chassis (00h)	03h
Sensor Device Commands		
Get Sensor Reading Factors	S/E (04h)	23h
Get Sensor Hysteresis	S/E (04h)	25h
Get Sensor Threshold	S/E (04h)	27h
Get Sensor Event Enable	S/E (04h)	29h
Get Sensor Event Status	S/E (04h)	2Bh
Get Sensor Reading	S/E (04h)	2Dh
Get Sensor Type	S/E (04h)	2Fh
FRU Device Commands		
Get FRU Inventory Area Info	Storage (0Ah)	10h
Read FRU Data	Storage (0Ah)	11h
Write FRU Data	Storage (0Ah)	12h
SDR Device Commands		
Get SDR Repository Info	Storage (0Ah)	20h
Get SDR Repository Allocation Info	Storage (0Ah)	21h
Get SDR	Storage (0Ah)	23h
Get SDR Repository Time	Storage (0Ah)	28h
SEL Device Commands		
Get SEL Info	Storage (0Ah)	40h
Get SEL Allocation Info	Storage (0Ah)	41h
Get SEL Entry	Storage (0Ah)	43h
Delete SEL Entry	Storage (0Ah)	46h

Clear SEL	Storage (0Ah)	47h
Get SEL Time	Storage (0Ah)	48h
Set SEL Time	Storage (0Ah)	49h
Get SEL Time UTC Offset	Storage (0Ah)	5Ch
Set SEL Time UTC Offset	Storage (0Ah)	5Dh
LAN Device Commands		
Set LAN Configuration Parameters	Transport (0Ch)	01h
Get LAN Configuration Parameters	Transport (0Ch)	02h
Serial/Modem Device Commands		
Set User Callback Options	Transport (0Ch)	1Ah
Get User Callback Options	Transport (0Ch)	1Bh
SOL Activating	Transport (0Ch)	20h
Set SOL Configuration Parameters	Transport (0Ch)	21h
Get SOL Configuration Parameters	Transport (0Ch)	22h

Using BMC Web UI

In the address bar of your Internet browser, input the IP address of the remote server to access the BMC interface of that server.

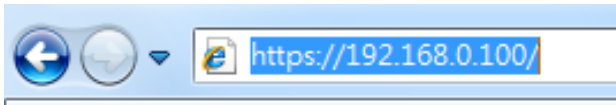

Initial access of BMC prompts you to enter username and password. A screenshot of the login screen is given below:

A screenshot of a login page. At the top, there is a green header with the text "Engineering Sample" in white. Below the header, there are two input fields: "Username" and "Password". Below these fields is a green button with the text "Sign in" in white.

Login Page

- ▶ **Username:** Enter your username in this field.
- ▶ **Password:** Enter your password in this field.
- ▶ **Sign me in:** After entering the required credentials, click the **Sign me in** to log in to Web UI.



Note

- (1) If not specified, the default IP to access BMC is <https://192.168.0.100>.
- (2) Please use **https** to access Web UI.

Default User Name and Password

- ▶ **Username:** admin
- ▶ **Password:** admin

The default username and password are in lower-case characters. When you log in using the default username and password, you will get full administrative rights, and it will ask you to change the default password once you log in. The dialog is shown below:

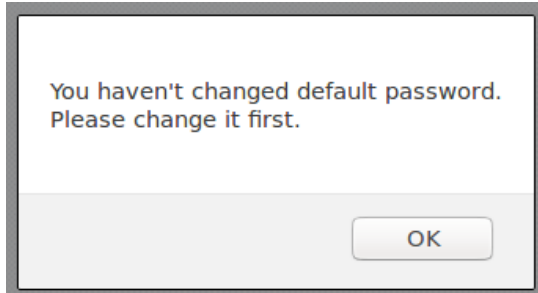

Change the default password - Dialog

Clicking **OK** will take you to the User Management Configuration page to set a password.

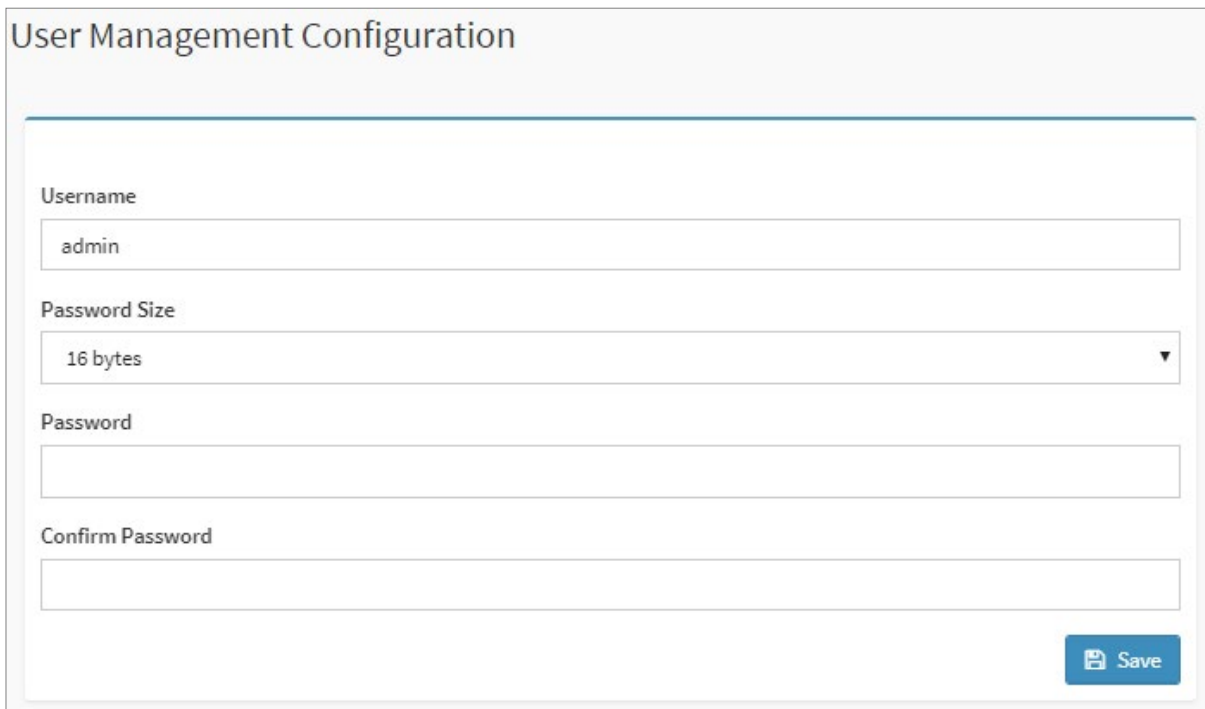

Change the default password – Set password



Note

Duplicate usernames shouldn't exist across various authentication methods like LDAP, RADIUS or IPMI since the privilege of one Authentication method is overwritten by another authentication method during logging in, and hence the correct privilege cannot be returned properly.

Web UI Layout

The BMC Web UI consists of various menu items:

Menu Bar

The menu bar displays the following:

- ▶ Dashboard
- ▶ Sensor
- ▶ Event Log
- ▶ Settings
- ▶ Remote Control
- ▶ Image Redirection
- ▶ Power Control
- ▶ Maintenance
- ▶ Sign out

A screenshot of the menu bar is shown below:

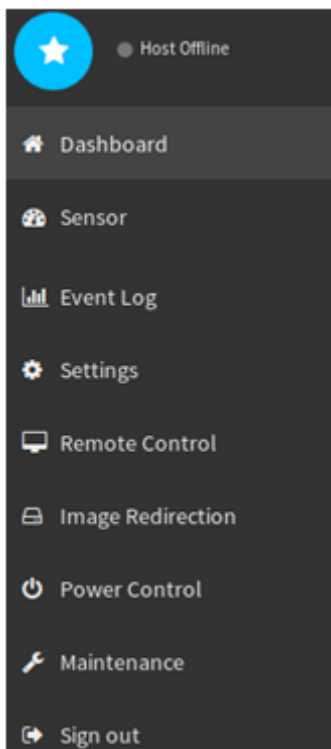

Menu Bar

Quick Button and Logged-in User

The user information and quick buttons are located at the top right of the Web UI.

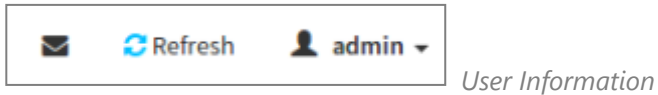

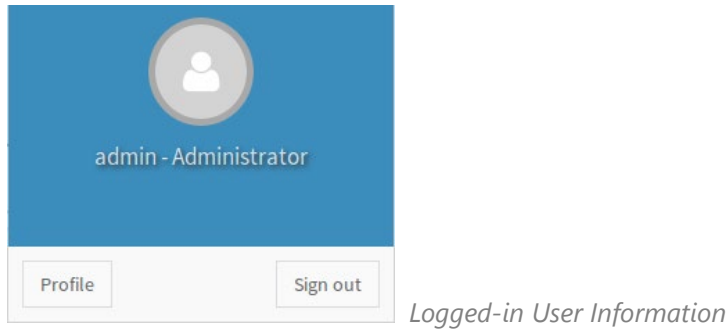

Logged-in user information: Click the icon  **admin** to view the logged-in user information.

A screenshot of the logged-in user information is shown below:

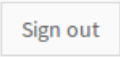

The logged-in user information shows the logged-in user's username, privilege, with the quick buttons allowing you to perform the following functions:

- ▶ **Notification:** Click the icon  to view the notification messages.
- ▶ **Refresh:** Click the icon  **Refresh** to reload the current page.
- ▶ **Sign out:** Click the icon  to log out of the Web UI.

Logged-in user and its privilege level

This option shows the logged-in username and privilege. There are four kinds of privileges:

- ▶ **User:** Only valid commands are allowed.
- ▶ **Operator:** All BMC commands are allowed except for the configuration commands that can change the behavior of the out-of-hand interfaces.
- ▶ **Administrator:** All BMC commands are allowed.
- ▶ **No Access:** Login access denied.

Help

Help: The **Help** icon  is located at the top right of each page in Web UI. Click this help icon to view more detailed field descriptions.

Installing Operating System

If your system is shipped without an operating system, install the supported operating system using the following resources.

Via IPMI Interface

1. Download the ISO image and make a bootable DVD from it.
2. Connect a DVD player or other type of readers (floppy disk, or a drive) to a computer.
3. Connect to your target system from this computer. (Refer to Remote Server Management for instructions on how to access the target system through Web UI).
4. After entering the main screen, click **"Launch KVM"** to open the Remote Control KVM page:

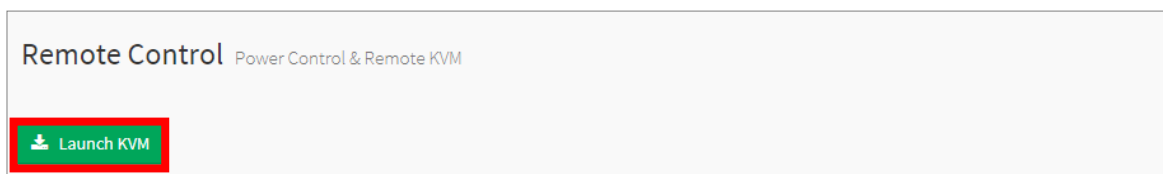

5. Click **"Browse File"** to select **CD Image**.

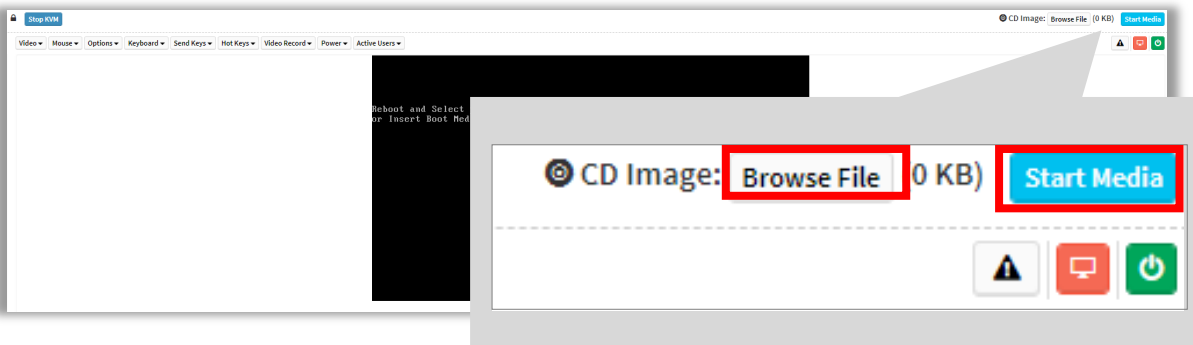

6. Click **"Start Media"** to redirect the selected CD image file to the Host.
7. The installation process will automatically start. Please follow the onscreen instruction to complete the rest of the steps and restart the target system manually.

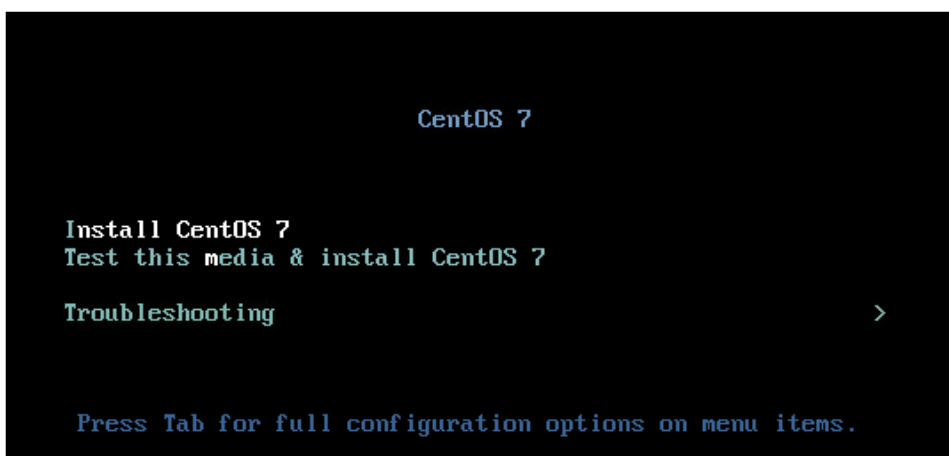

BIOS Setup

BIOS is a firmware embedded on an exclusive chip on the system's motherboard. Lanner's BIOS firmware offering including market-proven technologies such as Secure Boot and Intel Boot Guard technology deliver solid commitments for the shield protection against malware, uncertified sequences and other named cyber threats.

Main Setup Page

To enter the BIOS setup utility, simply follow the steps below:

1. Boot up the system.
2. Pressing the **<Esc>** or **** key immediately allows you to enter the Setup utility, and then you will be directed to the BIOS main screen. The instructions for BIOS navigations are as below:

Control Keys	Description
→←	select a setup screen
↑↓	select an item/option on a setup screen
<Enter>	select an item/option or enter a sub-menu
+/-	adjust values for the selected setup item/option
F1	display General Help screen
F2	retrieve previous values, such as the last configured parameters during the last time you entered BIOS
F3	load optimized default values
F4	save configurations and exit BIOS
<Esc>	exit the current screen

Setup main page contains BIOS information and project version information.

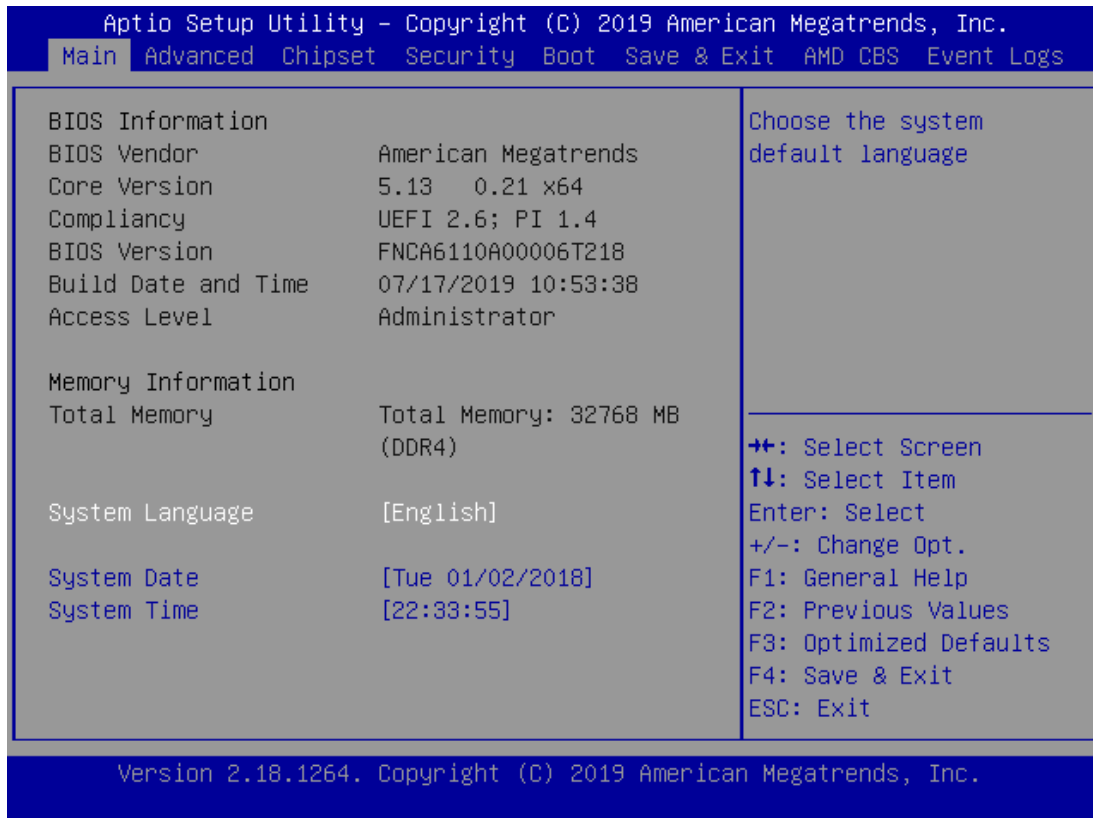

Feature	Description
BIOS Information	BIOS Vendor: American Megatrends Core Version: AMI Kernel version, CRB code base, X64 Compliance: UEFI version, PI version Project Version: BIOS release version Build Date and Time: MM/DD/YYYY Access Level: Administrator / User
System Date	To set the Date, use <Tab> to switch between Date elements. Default Range of Year: 2005-2099 Default Range of Month: 1-12 Days: dependent on Month.
System Time	To set the Date, use <Tab> to switch between Date elements.

Advanced Page

Select the **Advanced** menu item from the BIOS setup screen to enter the “Advanced” setup screen. Users can select any of the items in the left frame of the screen.

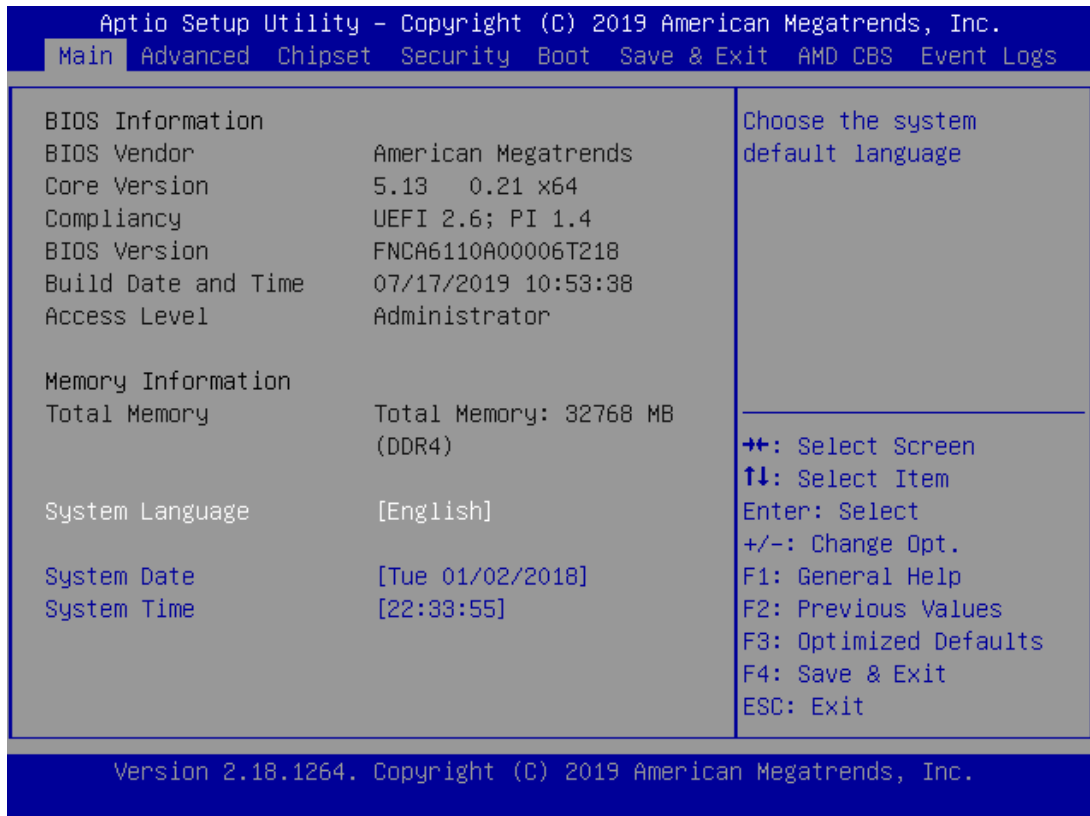

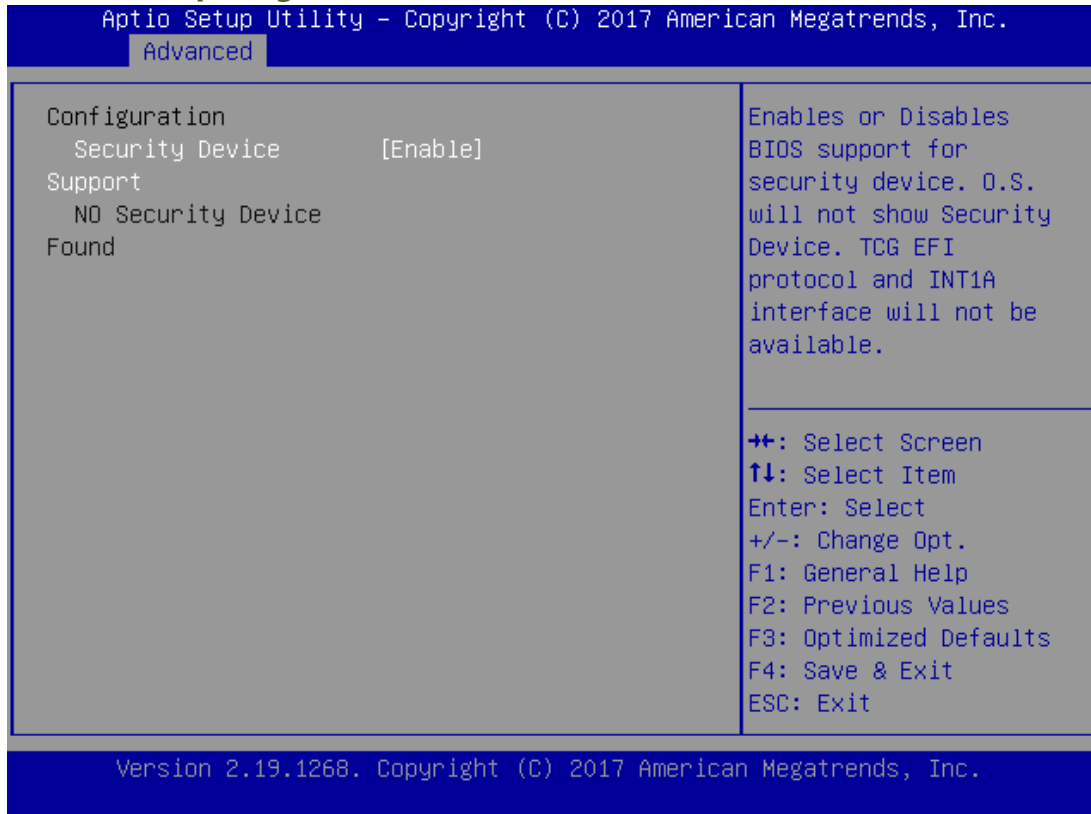

Trusted Computing

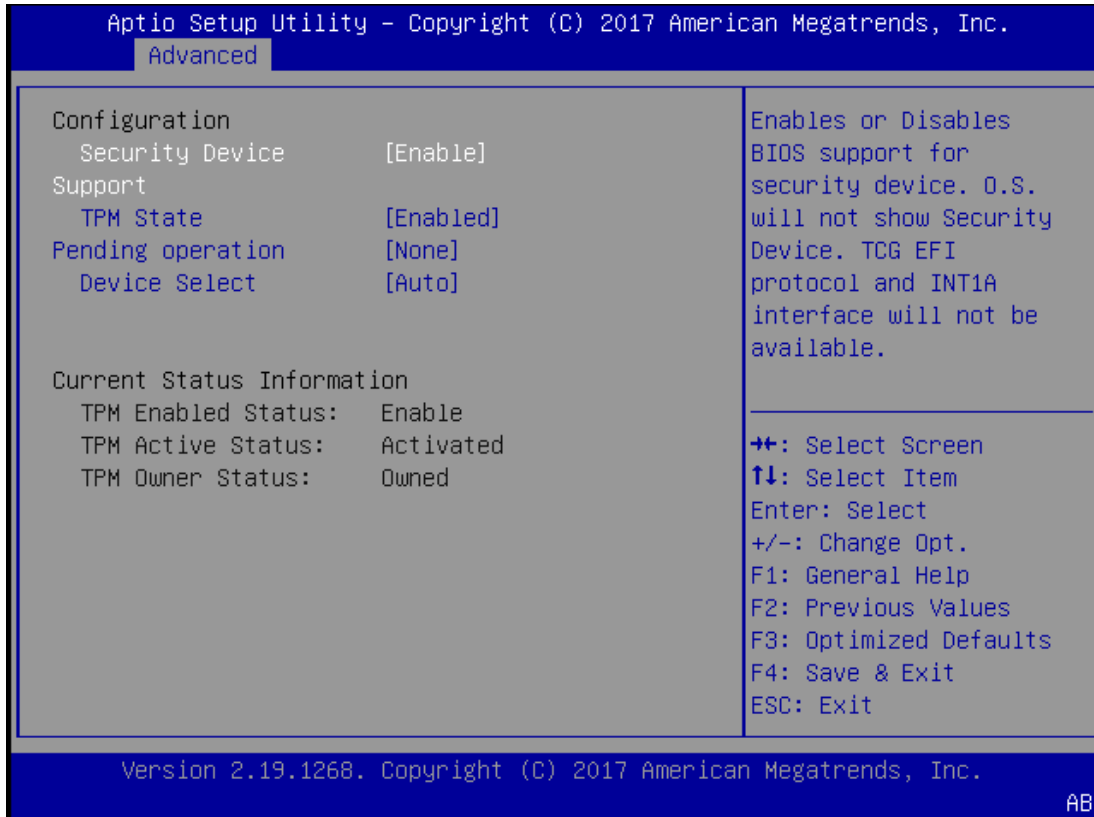

Feature	Options	Description
Security Device Support	<p>Enabled</p> <p>Disabled</p>	<p>Enables or disables BIOS support for security device. By disabling this function, OS will not show Security Device. TCG EFI protocol and INT1A interface will not be available.</p>

Trusted Computing (TPM1.2)



Feature	Options	Description
Security Device Support	Enabled Disabled	Enables or disables BIOS support for security device. By disabling this function, OS will not show Security Device. TCG EFI protocol and INT1A interface will not be available.
TPM State	Enabled Disabled	Enables or disables Security Device.  Note Your computer will reboot during restart in order to change State of the Device.
Pending operation	None TPM Clear	Schedules an Operation for the Security Device.  Note Your computer will reboot during restart in order to change State of the Device.
Device Select	TPM 1.2 TPM 2.0 Auto	TPM 1.2 will restrict support to TPM 1.2 devices; while TPM 2.0 will restrict support to TPM 2.0 devices; Auto will support both with the default set to TPM 2.0 devices. If not found, TPM 1.2 devices will be enumerated.

Trusted Computing (TPM2.0)

Aptio Setup Utility - Copyright (C) 2017 American Megatrends, Inc.

Advanced

TPM20 Device Found		▲ Enables or Disables BIOS support for security device. O.S. will not show Security Device. TCG EFI protocol and INT1A interface will not be available. ⇄+: Select Screen ⇅: Select Item Enter: Select +/-: Change Opt. F1: General Help F2: Previous Values F3: Optimized Defaults F4: Save & Exit ESC: Exit
Vendor: NTC		
Firmware Version: 1.3		
Security Device Support	[Enable]	
Active PCR banks	SHA-1,SHA256	
Available PCR banks	SHA-1,SHA256	
SHA-1 PCR Bank	[Enabled]	
SHA256 PCR Bank	[Enabled]	
Pending operation	[None]	
Platform Hierarchy	[Enabled]	
Storage Hierarchy	[Enabled]	
Endorsement Hierarchy	[Enabled]	

Version 2.19.1268. Copyright (C) 2017 American Megatrends, Inc.

AB



Aptio Setup Utility - Copyright (C) 2017 American Megatrends, Inc.

Advanced

Active PCR banks	SHA-1,SHA256	▲ TPM 1.2 will restrict support to TPM 1.2 devices, TPM 2.0 will restrict support to TPM 2.0 devices, Auto will support both with the default set to TPM 2.0 devices if not found, ⇄+: Select Screen ⇅: Select Item Enter: Select +/-: Change Opt. F1: General Help F2: Previous Values F3: Optimized Defaults F4: Save & Exit ESC: Exit
Available PCR banks	SHA-1,SHA256	
SHA-1 PCR Bank	[Enabled]	
SHA256 PCR Bank	[Enabled]	
Pending operation	[None]	
Platform Hierarchy	[Enabled]	
Storage Hierarchy	[Enabled]	
Endorsement Hierarchy	[Enabled]	
TPM2.0 UEFI Spec Version	[TCG_2]	
Physical Presence Spec Version	[1.3]	
TPM 20 InterfaceType	[TIS]	
Device Select	[Auto]	

Version 2.19.1268. Copyright (C) 2017 American Megatrends, Inc.

AB

Feature	Options	Description
Security Device Support	Enabled Disabled	Enables or disables BIOS support for security device. By disabling this function, OS will not show Security Device. TCG EFI protocol and INT1A interface will not be available.
SHA-1 PCR Bank	Enabled Disabled	Enables or disables SHA-1 PCR Bank.
SHA256 PCR Bank	Enabled Disabled	Enables or disables SHA256 PCR Bank.
Pending operation	None TPM Clear	Schedules an Operation for the Security Device.  Note Your computer will reboot during restart in order to change State of the Device.
Platform Hierarchy	Enabled Disabled	Enables or disables Platform Hierarchy.
Storage Hierarchy	Enabled Disabled	Enables or disables Storage Hierarchy.
Endorsement Hierarchy	Enabled Disabled	Enables or disables Endorsement Hierarchy.
TPM2.0 UEFI Spec Version	TCG_1_2 TCG_2	Select the TCG2 Spec Version, TCG_1_2 : Supports the Compatible mode for Win8/Win10 TCG_2 : Supports new TCG2 protocol and event format for Win10 or later.
Physical Presence Spec Version	1.2 1.3	Select to tell OS to support PPI Spec Version 1.2 or 1.3.  Note Some HCK tests might not support 1.3.
TPM 20 InterfaceType	TIS	Select TPM 20 Device for the Communication Interface.
Device Select	TPM 1.2 TPM 2.0 Auto	TPM 1.2 will restrict support to TPM 1.2 devices; while TPM 2.0 will restrict support to TPM 2.0 devices; Auto will support both with the default set to TPM 2.0 devices. If not found, TPM 1.2 devices will be enumerated.

PSP Firmware Versions

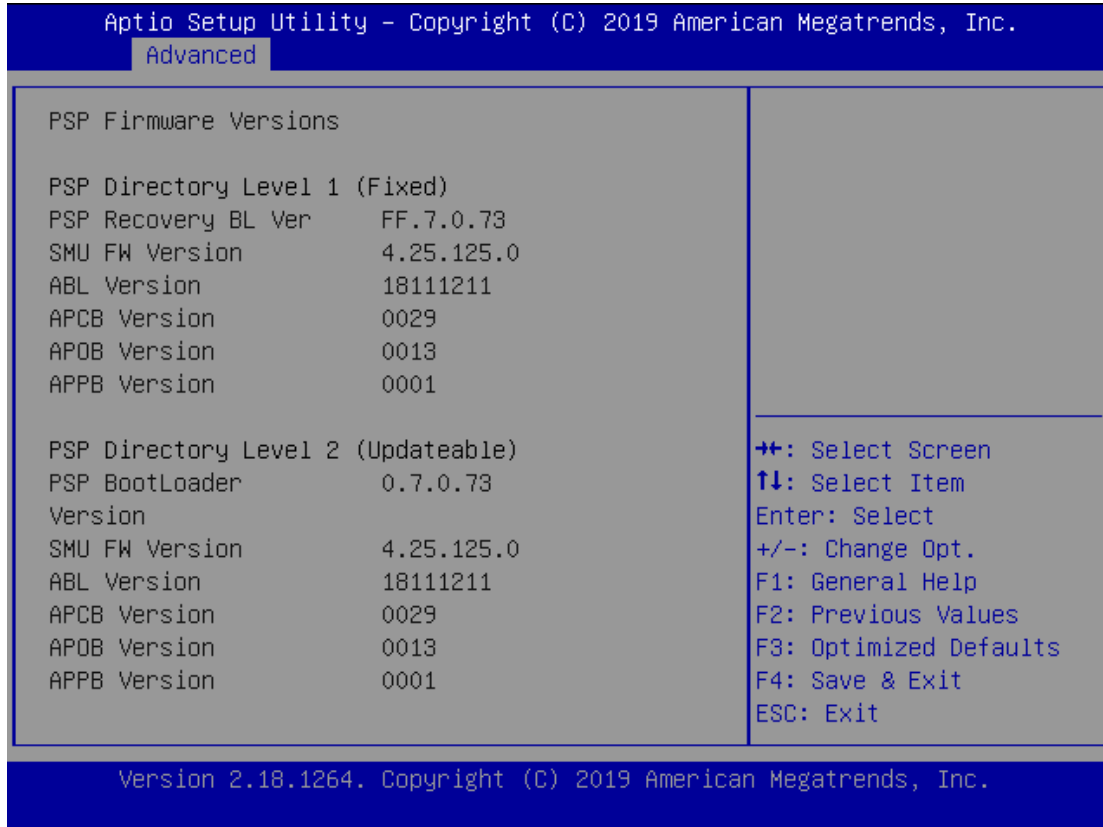

Feature	Description
PSP Firmware Versions	PSP Recovery BL Ver SMU FW Version ABL Version APCB Version APOB Version APPB Version

NCT7904D HW Monitor

```

Aptio Setup Utility - Copyright (C) 2019 American Megatrends, Inc.
  Advanced
  Pc Health Status
  ▶ Smart Fan Mode Configuration
    CPU0 Temp      : +64 C
    CPU1 Temp      : +52 C
    System Temp1   : +46 C
    System Temp2   : +47 C
    Fan1A Speed    : 5192 RPM
    Fan2A Speed    : N/A
    Fan3A Speed    : N/A
    Fan4A Speed    : 3868 RPM
    Fan5A Speed    : N/A
    Fan6A Speed    : N/A
    12V_SENSE      : +12.072 V
    P5V_SENSE      : +4.986 V
    SOC_RUN_P0     : +0.968 V
    SOC_RUN_P1     : +0.990 V
    P0_VDDCR_SOC_DUAL : +0.902 V
  Smart Fan Mode Select
  ++: Select Screen
  ↑↓: Select Item
  Enter: Select
  +/-: Change Opt.
  F1: General Help
  F2: Previous Values
  F3: Optimized Defaults
  F4: Save & Exit
  ESC: Exit
  Version 2.18.1264. Copyright (C) 2019 American Megatrends, Inc.
  
```

```

Aptio Setup Utility - Copyright (C) 2019 American Megatrends, Inc.
  Advanced
  Smart Fan Mode Configuration
  Fan Out Mode      [Smart Fan Mode]
  Target            65
  Temperature1(T1) Target 70
  Temperature1(T2) Target 75
  Temperature1(T3) Target 80
  Temperature1(T4) Target 90
  Critical Temperature 90
  FanOut T1 Level1 60
  FanOut T1 Leve2 100
  FanOut T1 Leve3 150
  FanOut T1 Leve4 220
  Fan Mode Select
  ++: Select Screen
  ↑↓: Select Item
  Enter: Select
  +/-: Change Opt.
  F1: General Help
  F2: Previous Values
  F3: Optimized Defaults
  F4: Save & Exit
  ESC: Exit
  Version 2.18.1264. Copyright (C) 2019 American Megatrends, Inc.
  
```

Watch Dog Timer Configuration

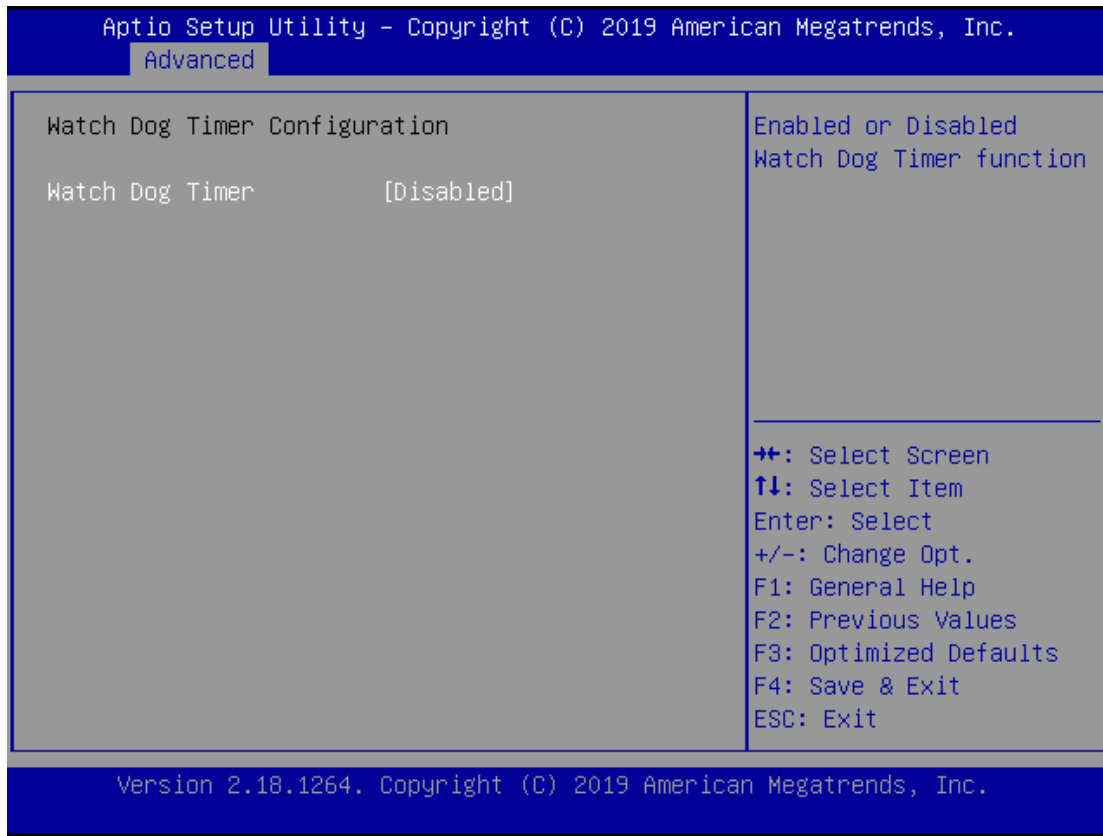

Feature	Options	Description
Watch Dog Timer	Enabled Disabled	Enable / Disable Watch Dog Timer

Control Legacy PXE Boot

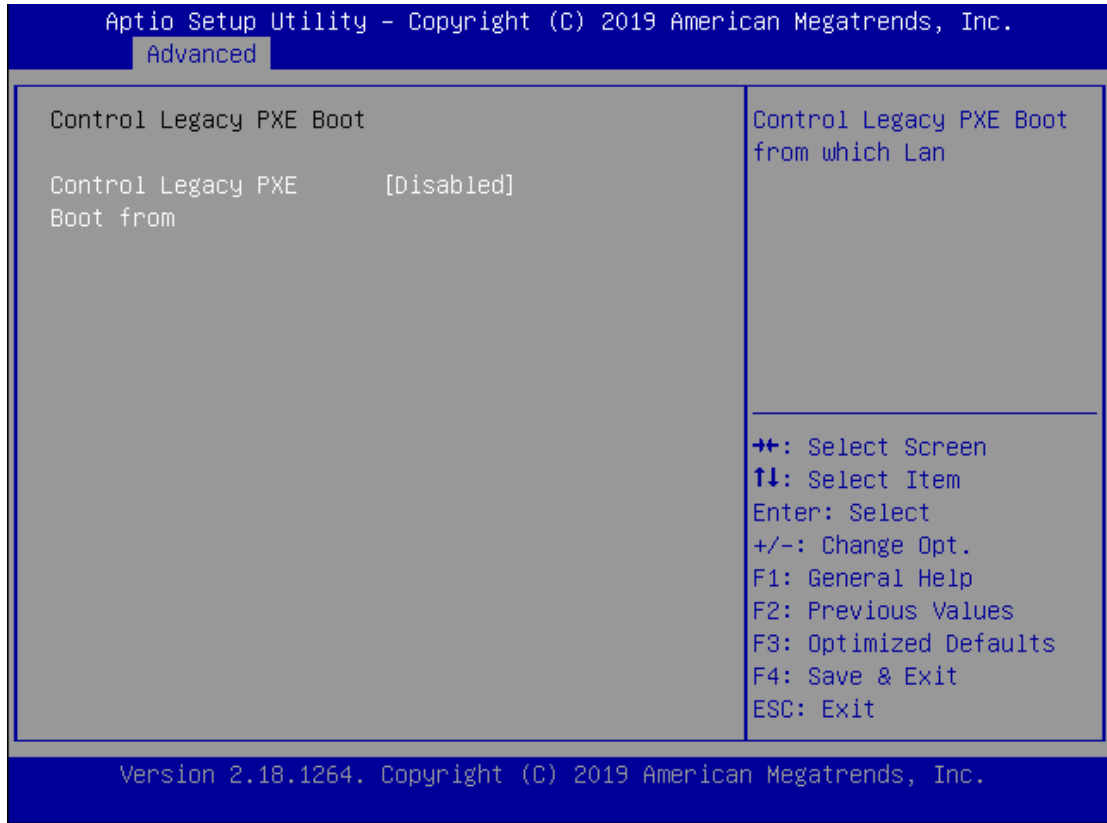

Feature	Options	Description
Control Legacy PXE Boot from	Enabled Disabled	PXE Enable or Disable.

Serial Port Console Redirection

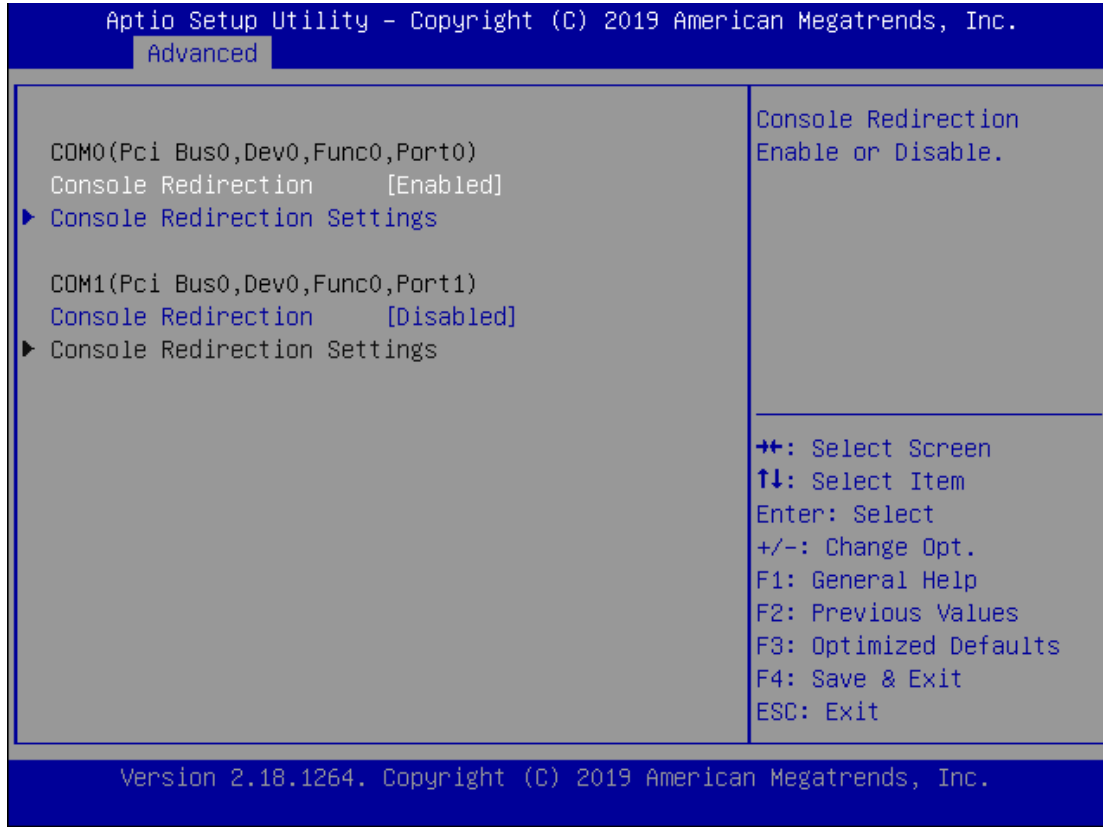

Feature	Options	Description
COM0 Console Redirection	Enabled Disabled	Console Redirection Enable or Disable.
COM1 Console Redirection	Enabled Disabled	Console Redirection Enable or Disable.

Aptio Setup Utility - Copyright (C) 2019 American Megatrends, Inc.

Advanced

COM0(Pci Bus0,Dev0,Func0,Port0) Console Redirection Settings		Emulation: ANSI: Extended ASCII char set. VT100: ASCII char set. VT100+: Extends VT100 to support color, function keys, etc. VT-UTF8: Uses UTF8 encoding to map Unicode
Terminal Type	[VT100+]	▲ ▼ ⇐: Select Screen ⇕: Select Item Enter: Select +/-: Change Opt. F1: General Help F2: Previous Values F3: Optimized Defaults F4: Save & Exit ESC: Exit
Bits per second	[115200]	
Data Bits	[8]	
Parity	[None]	
Stop Bits	[1]	
Flow Control	[None]	
VT-UTF8 Combo Key Support	[Enabled]	
Recorder Mode	[Disabled]	
Resolution 100x31	[Disabled]	
Putty KeyPad	[VT100]	

Version 2.18.1264. Copyright (C) 2019 American Megatrends, Inc.

Watch Dog Timer Configuration

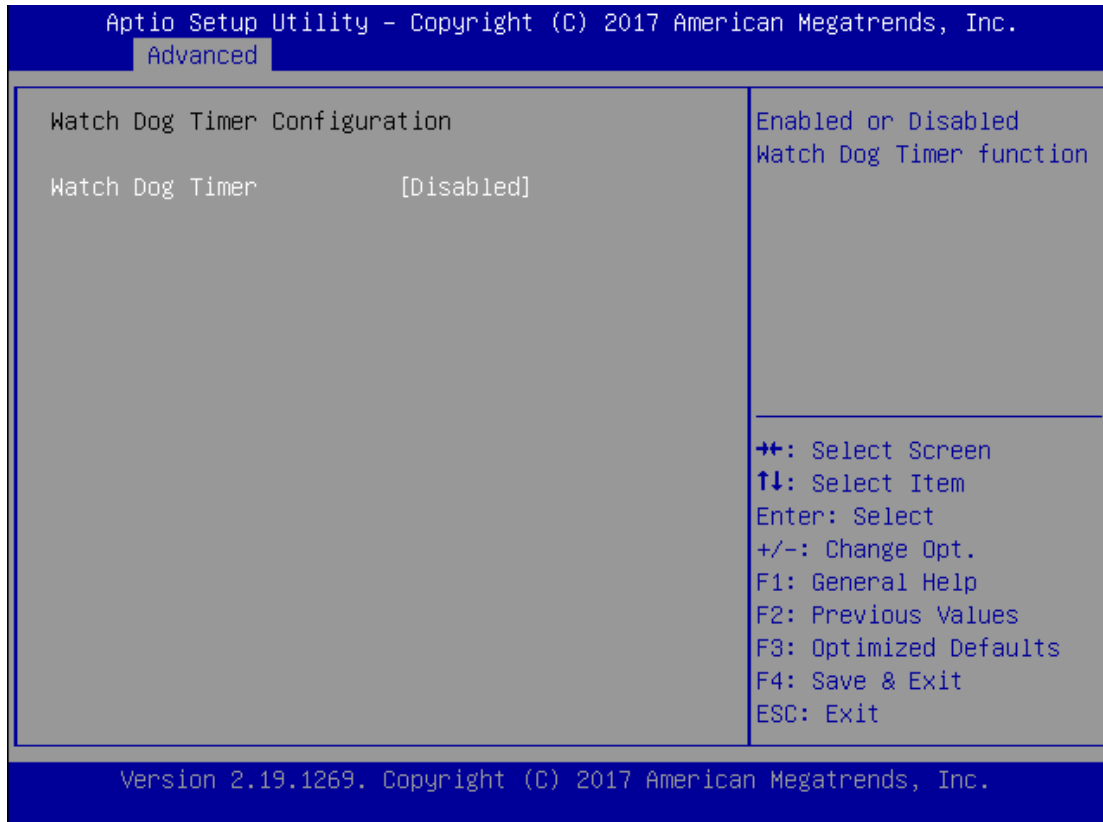

Feature	Options	Description
Watch Dog Timer	Enabled Disabled	Enables or disables Watch Dog Timer function

Serial Port Console Redirection

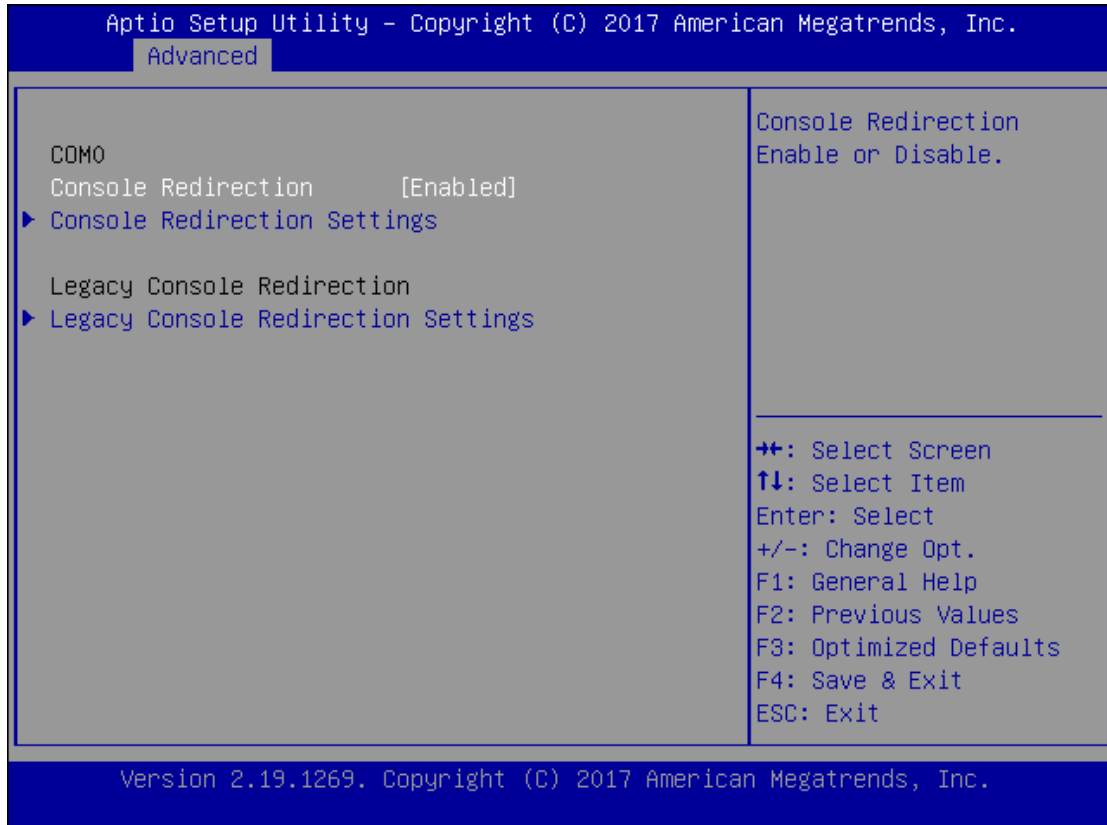

Feature	Options	Description
COM0 Console Redirection	Enabled Disabled	Enables or disables Console Redirection

Console Redirection Settings

Aptio Setup Utility - Copyright (C) 2017 American Megatrends, Inc.

Advanced

COM0 Console Redirection Settings		Emulation: ANSI: Extended ASCII char set. VT100: ASCII char set. VT100+: Extends VT100 to support color, function keys, etc. VT-UTF8: Uses UTF8 encoding to map Unicode
Terminal Type	[VT100+]	<hr/> →→ : Select Screen ↑↓ : Select Item Enter : Select +/- : Change Opt. F1 : General Help F2 : Previous Values F3 : Optimized Defaults F4 : Save & Exit ESC : Exit
Bits per second	[115200]	
Data Bits	[8]	
Parity	[None]	
Stop Bits	[1]	
Flow Control	[None]	
VT-UTF8 Combo Key Support	[Enabled]	
Recorder Mode	[Disabled]	
Resolution 100x31	[Disabled]	
Putty KeyPad	[VT100]	

Version 2.19.1269. Copyright (C) 2017 American Megatrends, Inc.

Feature	Options	Description
Terminal Type	VT100 VT100+ VT-UTF8 ANSI	VT100 : ASCII char set VT100+ :Extends VT100 to support color, function keys, etc. VT-UTF8 :Uses UTF8 encoding to map Unicode chars onto 1 or more bytes ANSI : Extended ASCII char set
Bits per second	9600 19200 38400 57600 115200	Selects serial port transmission speed. The speed must be matched on the other side. Long or noisy lines may require lower speeds.
Data Bits	7 8	Data Bits
Parity	None Even Odd Mark Space	A parity bit can be sent with the data bits to detect some transmission errors.
Stop Bits	1 2	Indicates the end of a serial data packet.
Flow Control	None Hardware RTS/CTS	Flow Control can prevent data loss from buffer overflow.

VT-UTF8 Combo Key Support	Disabled Enabled	Enables VT-UTF8 Combination Key Support for ANSI/VT100 terminals
Recorder Mode	Disabled Enabled	With this mode enabled, only text will be sent. This is to capture Terminal data.
Resolution 100x31	Disabled Enabled	Enables or disables extended terminal resolution
Putty KeyPad	VT100 LINUX XTERM86 SCO ESCN VT400	Selects FunctionKey and KeyPad on Putty.

CPU Configuration

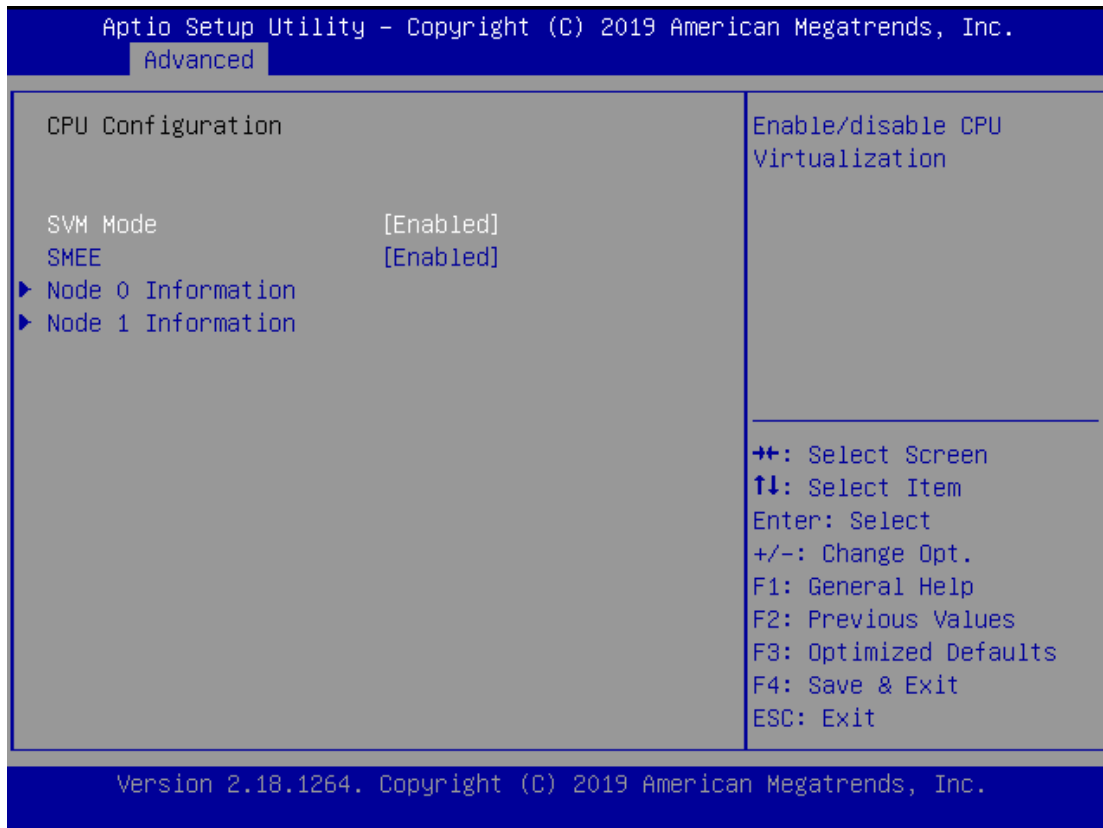

Feature	Options	Description
SVM Mode	Disabled Enabled	Enable/disable CPU Virtualization
SMEE	Disabled Enabled	Control secure memory encryption enable

Node 0 Information

```

Aptio Setup Utility - Copyright (C) 2019 American Megatrends, Inc.
  Advanced

Node 0 Information

AMD EPYC 7281 16-Core Processor
16 Cores 32 Threads
Running @ 2114 MHz 687 mV
Processor Family: 17h
Processor Model: 00h-0Fh
Microcode Patch Level: 8001230

----- Cache per Core -----
L1 Instruction Cache: 64 KB/4-way
    L1 Data Cache: 32 KB/8-way
    L2 Cache: 512 KB/8-way

L3 Cache per Socket: 32 MB/64-way

++: Select Screen
↑↓: Select Item
Enter: Select
+/-: Change Opt.
F1: General Help
F2: Previous Values
F3: Optimized Defaults
F4: Save & Exit
ESC: Exit

Version 2.18.1264. Copyright (C) 2019 American Megatrends, Inc.
    
```

Node 1 Information

```

Aptio Setup Utility - Copyright (C) 2019 American Megatrends, Inc.
  Advanced

Node 1 Information

AMD EPYC 7281 16-Core Processor
16 Cores 32 Threads
Running @ 2115 MHz 687 mV
Processor Family: 17h
Processor Model: 00h-0Fh
Microcode Patch Level: 8001230

----- Cache per Core -----
L1 Instruction Cache: 64 KB/4-way
    L1 Data Cache: 32 KB/8-way
    L2 Cache: 512 KB/8-way

L3 Cache per Socket: 32 MB/64-way

++: Select Screen
↑↓: Select Item
Enter: Select
+/-: Change Opt.
F1: General Help
F2: Previous Values
F3: Optimized Defaults
F4: Save & Exit
ESC: Exit

Version 2.18.1264. Copyright (C) 2019 American Megatrends, Inc.
    
```

PCI Subsystem Settings

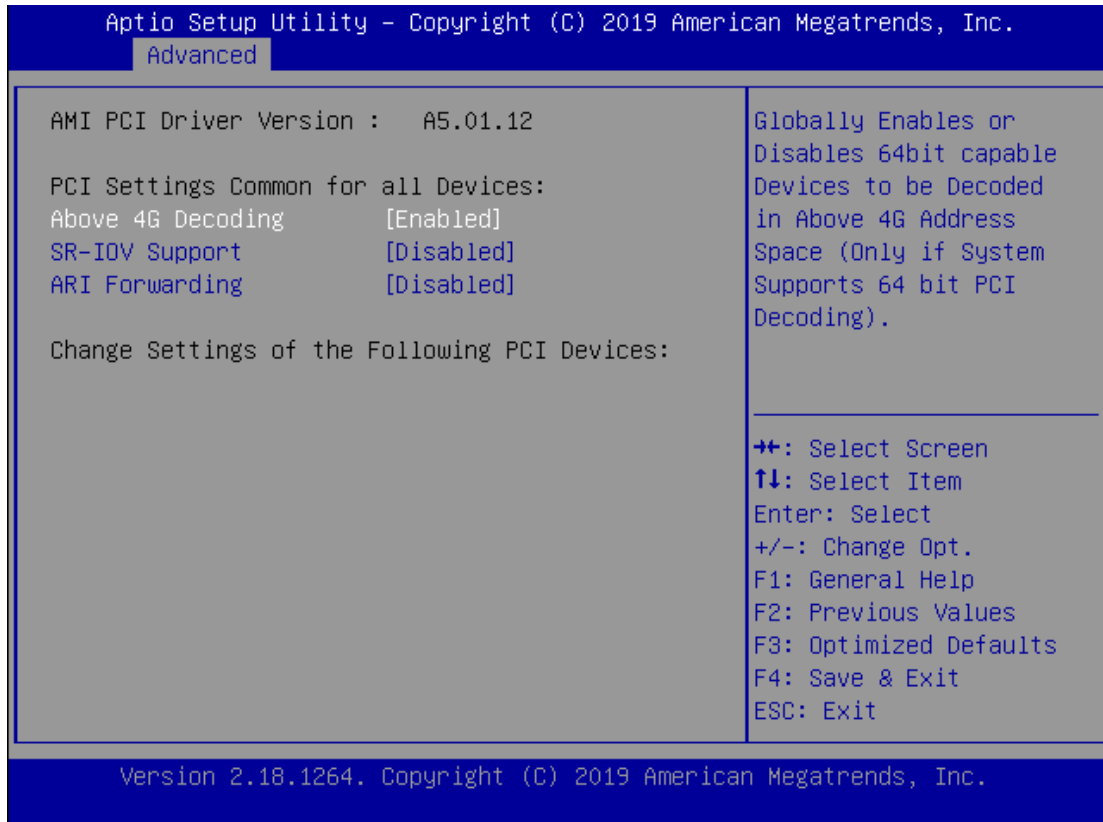

Feature	Options	Description
Above 4G Decoding	Disabled Enabled	Globally Enables or Disables 64bit capable Devices to be Decoded in Above 4G Address Space (Only if System Supports 64 bit PCI Decoding).
SR-IOV Support	Disabled Enabled	If system has SR-IOV capable PCIe Devices, this option Enables or Disables Single Root IO Virtualization Support.
ARI Forwarding	Disabled Enabled	If supported by hardware and set to 'Enabled', the Downstream Port disables its traditional Device Number field being 0 enforcement when turning a Type1 Configuration Request into a Type0 Configuration Request, permitting access to Extended Functions in an ARI Device immediately below the Port. Default value: Disabled

Network Stack

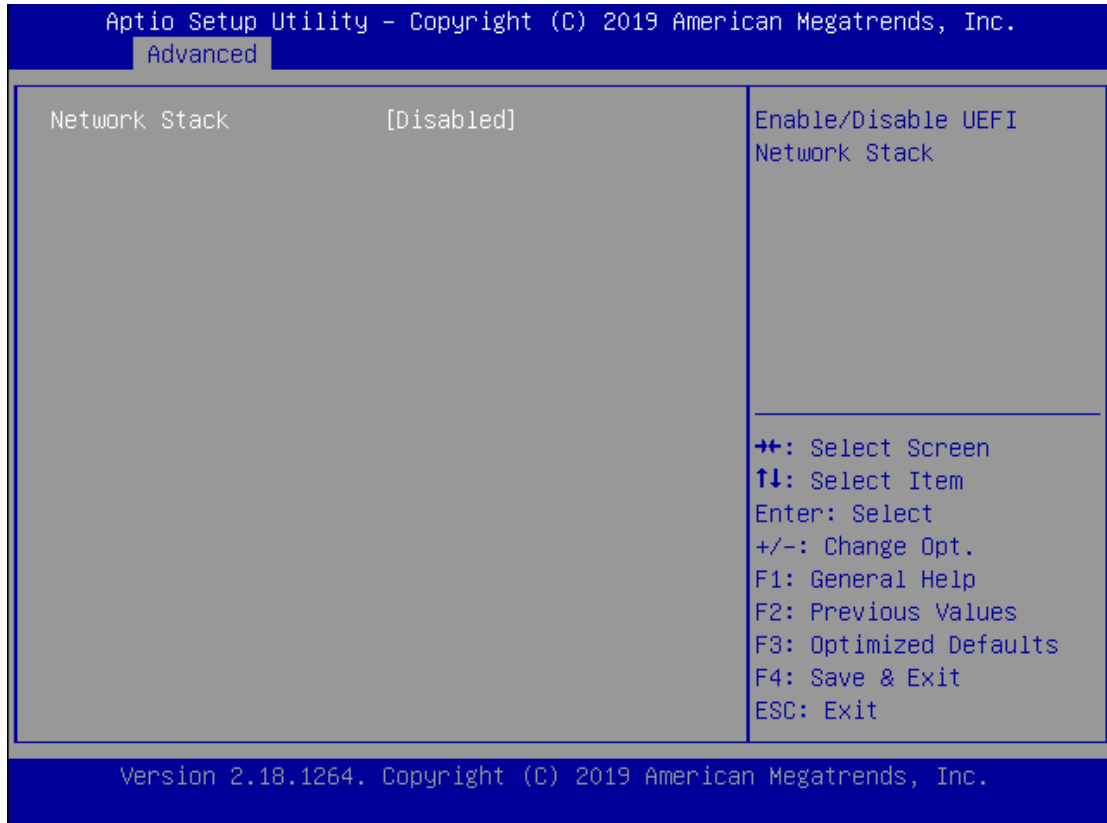

CSM Configuration

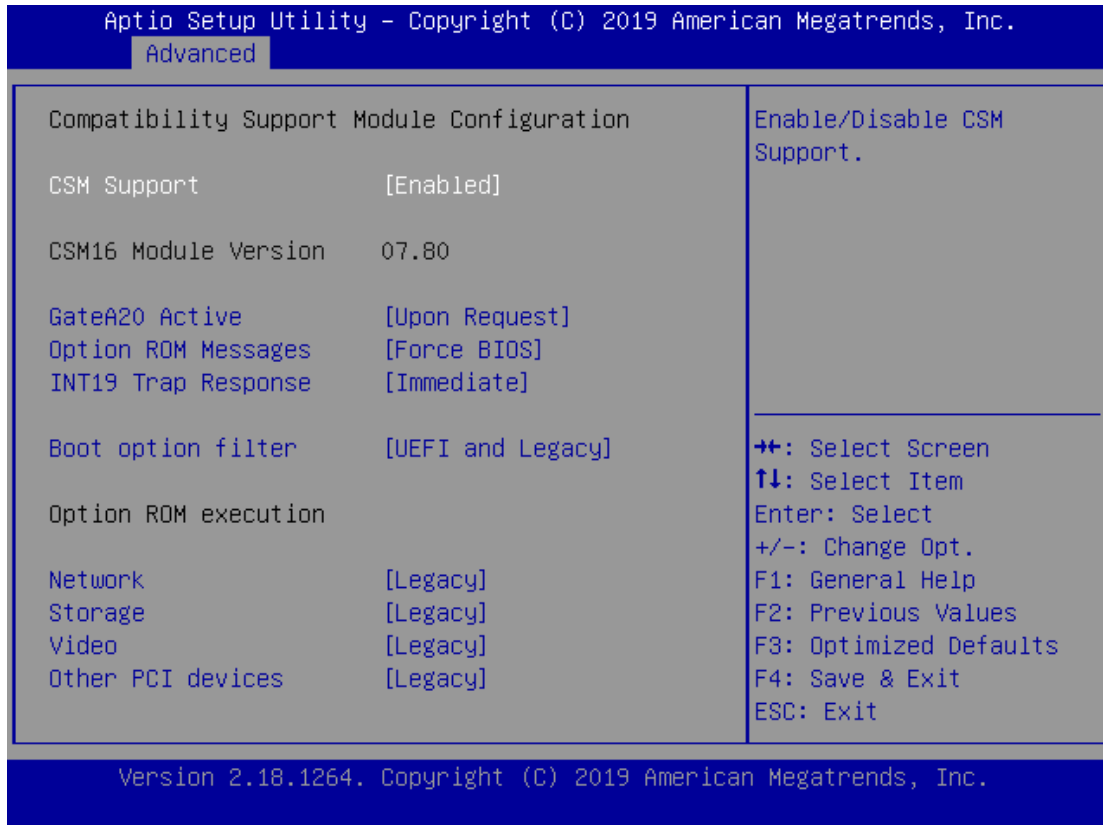

Feature	Options	Description
GateA20 Active	Upon Request Always	UPON REQUEST - GA20 can be disabled using BIOS services. ALWAYS - do not allow disabling GA20; this option is useful when any RT code is executed above 1MB.
Option ROM Messages	Force BIOS Keep Current	Set display mode for Option ROM
INT19 Trap Response	Immediate Postponed	BIOS reaction on INT19 trapping by Option ROM: IMMEDIATE - execute the trap right away; POSTPONED - execute the trap during legacy boot.
Boot option filter	UEFI and Legacy Legacy only UEFI only	This option controls Legacy/UEFI ROMs priority
CSM Support	Disabled Enabled	Enables or disables CSM Support
Network	Do Not Launch UEFI Legacy	Controls the execution of UEFI and Legacy PXE OpROM
Storage	Do Not Launch	Controls the execution of UEFI and Legacy

	UEFI Legacy	Storage OpROM
Video	Do Not Launch UEFI Legacy	Controls the execution of UEFI and Legacy Video OpROM
Other PCI device	Do Not Launch UEFI Legacy	Determines OpROM execution policy for devices other than Network, Storage, or Video

SATA configuration

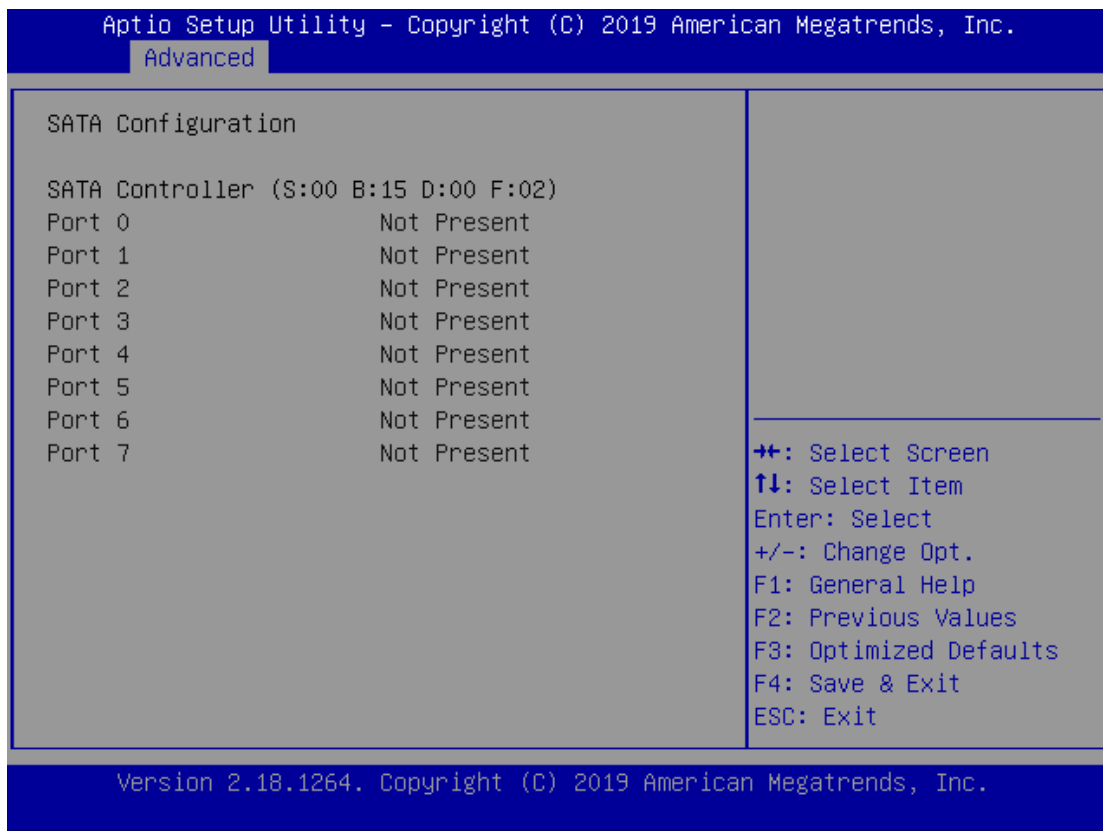

USB configuration

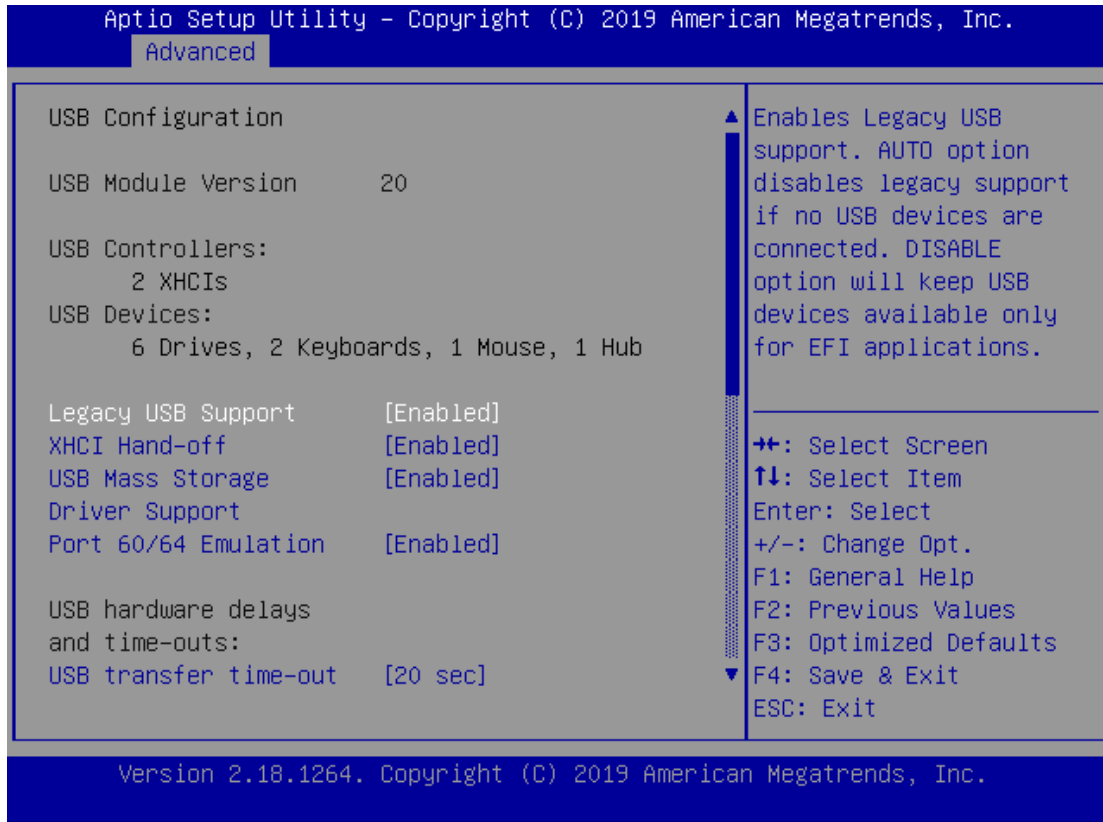

Feature	Options	Description
Legacy USB Support	Enabled Disabled Auto	Enables Legacy USB support. Auto option disables legacy support if no USB devices are connected; Disabled option will keep USB devices available only for EFI applications.
XHCI Hand-off	Enabled Disabled	This is a workaround for OSES without XHCI hand-off support. The XHCI ownership change should be claimed by XHCI driver.
USB Mass Storage Driver Support	Enabled Disabled	Enables or disables USB Mass Storage Driver Support.
Port 60/64 Emulation	Enabled Disabled	Enables I/O port 60h/64h emulation support. This should be enabled for the complete USB keyboard legacy support for non-USB aware OSES.
USB transfer time-out	1 sec 5 sec 10 sec 20 sec	The time-out value for Control, Bulk, and Interrupt transfers

Device reset time-out	<p>1 sec</p> <p>5 sec</p> <p>10 sec</p> <p>20 sec</p>	USB mass storage device Start Unit command time-out
Device power-up delay	<p>Auto</p> <p>Manual</p>	<p>Maximum time the device will take before it properly reports itself to the Host Controller. Auto uses default value: for a Root port, it is 100 ms, for a Hub port the delay is taken from Hub descriptor.</p>

Chipset Page

Select the Chipset menu item from the BIOS setup screen to enter the Platform Setup screen. Users can select any of the items in the left frame of the screen.

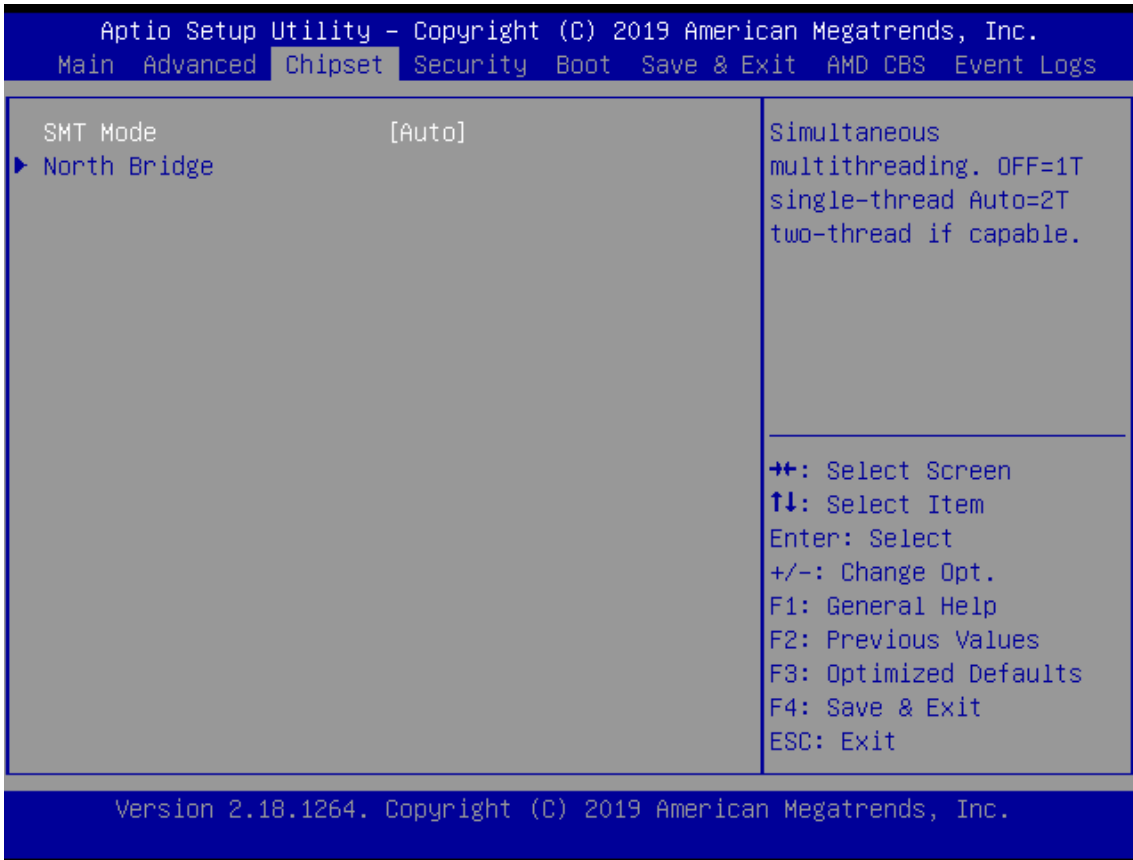

Feature	Options	Description
SMT Mode	Off Auto	Simultaneous multithreading. OFF=1T single-thread Auto=2T two-thread if capable.

North Bridge

Aptio Setup Utility - Copyright (C) 2019 American Megatrends, Inc.

Chipset

<p>North Bridge Configuration</p> <p>Memory Information</p> <p>Total Memory: 32768 MB (DDR4)</p> <p>▶ Socket 0 Information</p> <p>▶ Socket 1 Information</p>	<p>View Information related to Socket 0</p> <hr/> <p>←→: Select Screen ↑↓: Select Item Enter: Select +/-: Change Opt. F1: General Help F2: Previous Values F3: Optimized Defaults F4: Save & Exit ESC: Exit</p>
--	---

Version 2.18.1264. Copyright (C) 2019 American Megatrends, Inc.

Aptio Setup Utility - Copyright (C) 2019 American Megatrends, Inc.

Chipset

<p>Socket 0 Information</p> <p>P0_DIMM_A0: Not Present</p> <p>P0_DIMM_B0: Not Present</p> <p>P0_DIMM_C0: Not Present</p> <p>P0_DIMM_D0: Not Present</p> <p>P0_DIMM_E0: Not Present</p> <p>P0_DIMM_F0: Not Present</p> <p>P0_DIMM_G0: Size 32768 MB, Speed 2667 MT/s</p> <p>P0_DIMM_H0: Not Present</p>	<p>▲</p> <hr/> <p>←→: Select Screen ↑↓: Select Item Enter: Select +/-: Change Opt. F1: General Help F2: Previous Values F3: Optimized Defaults ▼ F4: Save & Exit ESC: Exit</p>
--	--

Version 2.18.1264. Copyright (C) 2019 American Megatrends, Inc.

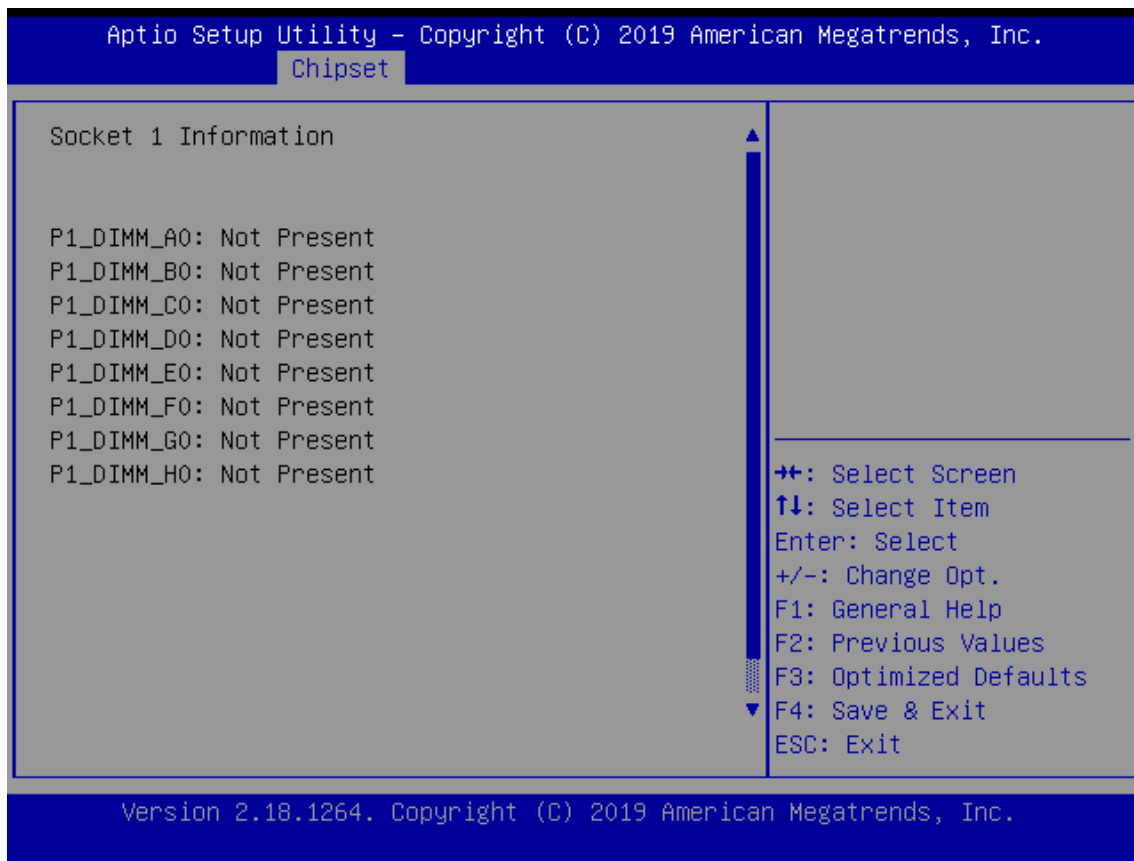

Security Page

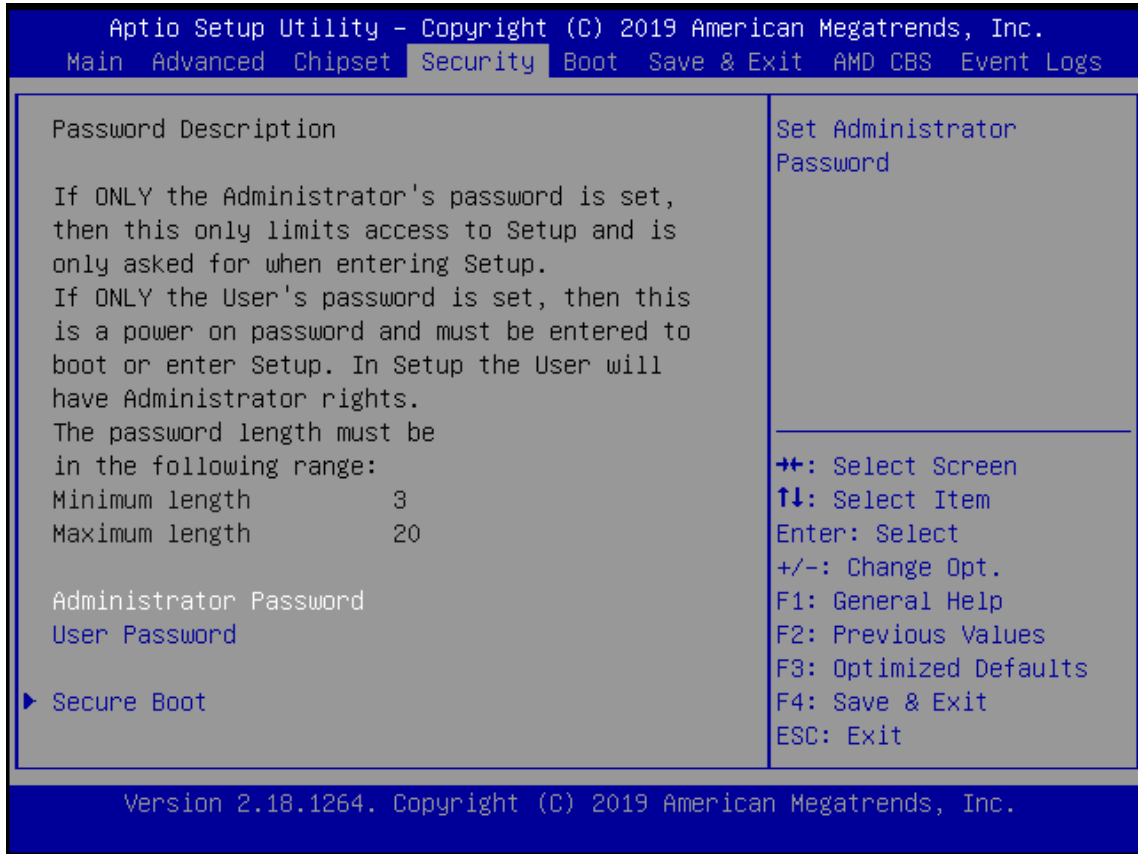

Feature	Description
Administrator Password	If ONLY the Administrator's password is set, it only limits access to Setup and is only asked for when entering Setup.
User Password	If ONLY the User's password is set, it serves as a power-on password and must be entered to boot or enter Setup. In Setup, the User will have Administrator rights.

Secure Boot

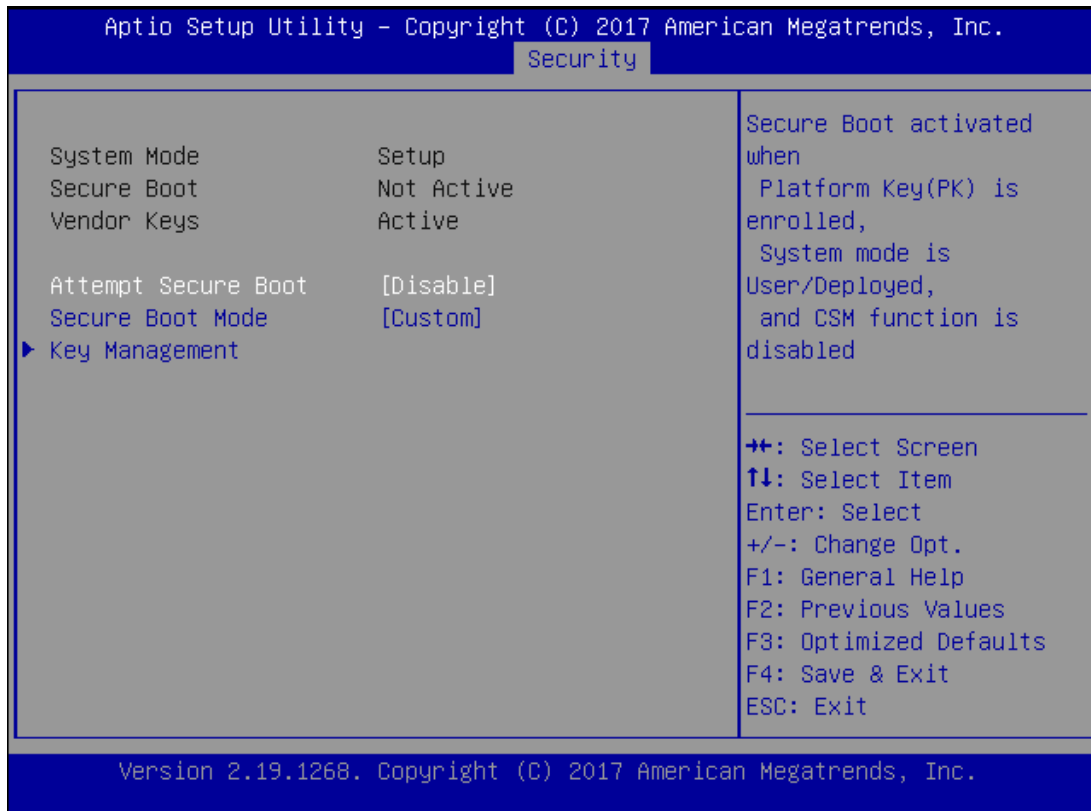

Feature	Options	Description
Attempt Secure Boot	Disabled Enabled	Secure Boot is activated when Platform Key(PK) is enrolled, System mode is User/Deployed, and CSM function is disabled.
Secure Boot Mode	Standard Custom	Secure Boot mode selector: In Custom mode, Secure BootVariables can be configured without authentication

Key Management

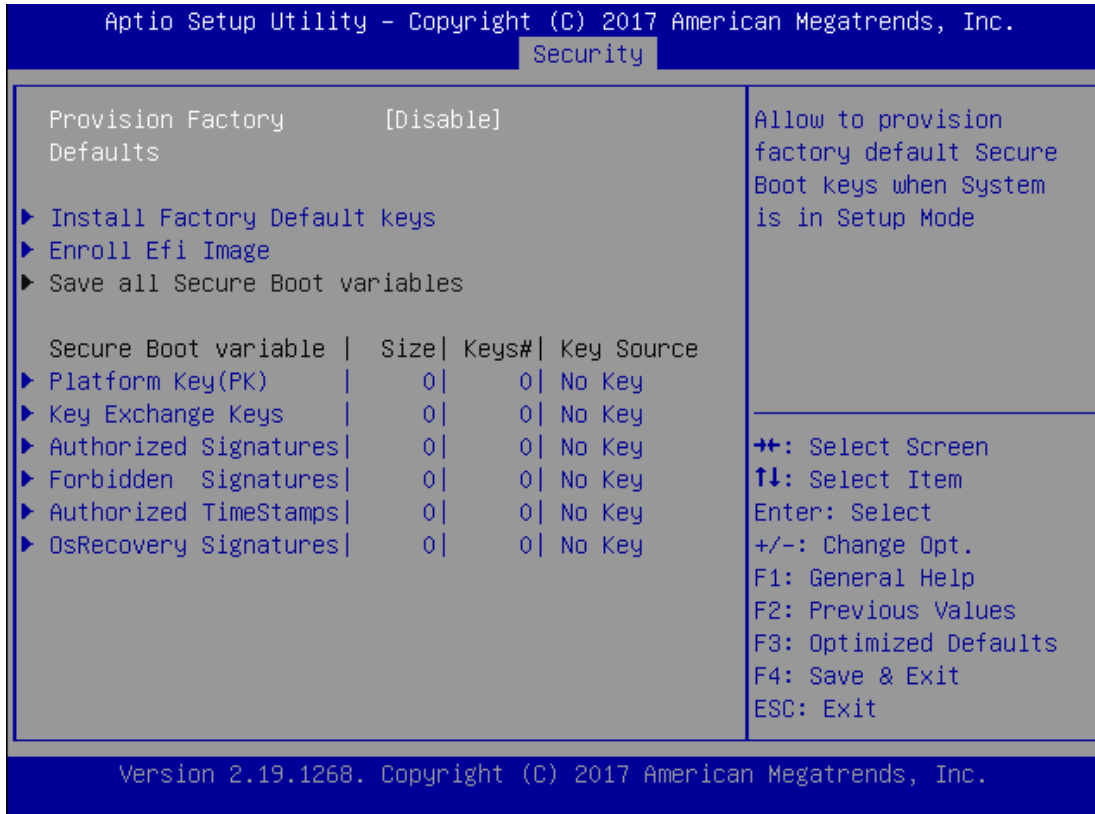

Feature	Options	Description
Provision Factory Defaults	Disabled Enabled	Allows User to provision factory default Secure Boot keys when System is in Setup Mode.
Install Factory Default keys	None	Forces System to User Mode - install all Factory Default keys
Enroll Efi Image	None	Allows the image to run in Secure Boot mode. Enroll SHA256 hash of the binary into Authorized Signature Database (db)

Boot Page

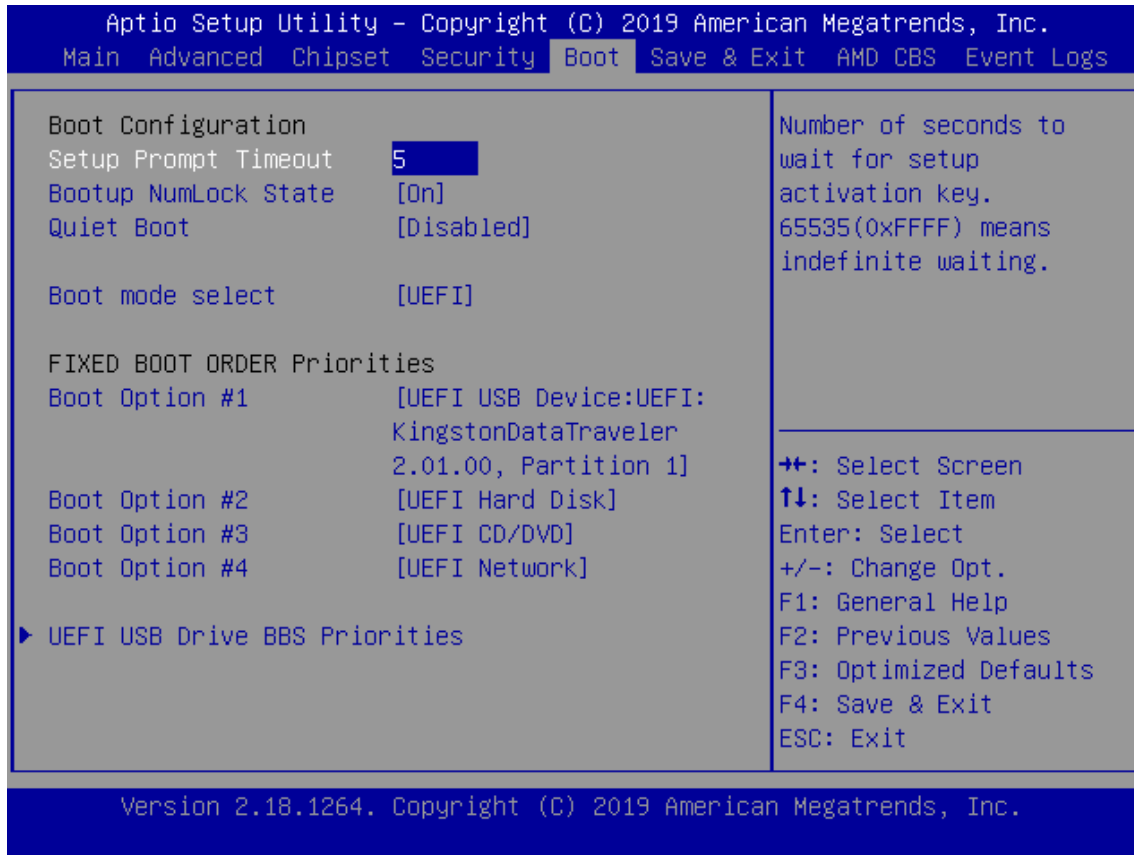

Feature	Options	Description
Setup Prompt Timeout	5	The Number of seconds to wait for setup activation key. 65535 means indefinite waiting.
BootupNumLock State	On Off	Select the keyboard NumLock state.
Quiet Boot	Enabled	Enables or disables Quiet Boot option.
Boot mode select	LEGACY UEFI DUAL	Select boot mode for LEGACY or UEFI.

- Choose boot priority from boot option group.
- Choose specifies boot device priority sequence from available Group device.

Save and Exit Page

Select the Save and Exit menu item from the BIOS setup screen to enter the Save and Exit Setup screen. Users can select any of the items in the left frame of the screen.

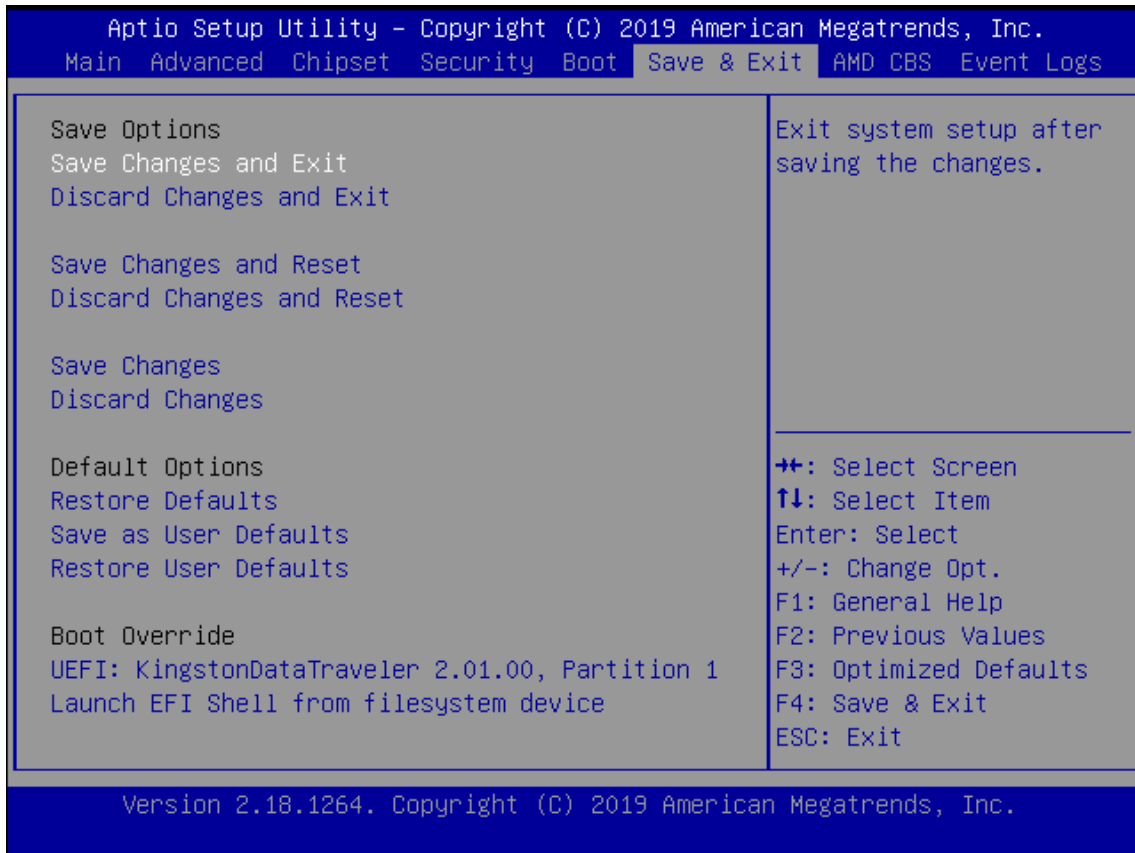

Discard Changes and Reset

Select this option to quit Setup without saving any modifications to the system configuration. The following window will appear after the **“Discard Changes and Exit”** option is selected. Select **“Yes”** to Discard changes and Exit Setup.

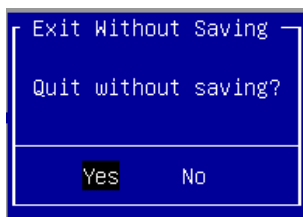

Save Changes and Reset

When Users have completed the system configuration changes, select this option to save the changes and reset from BIOS Setup in order for the new system configuration parameters to take effect. The following window will appear after selecting the **“Save Changes and Reset”** option is selected. Select **“Yes”** to Save Changes and reset.

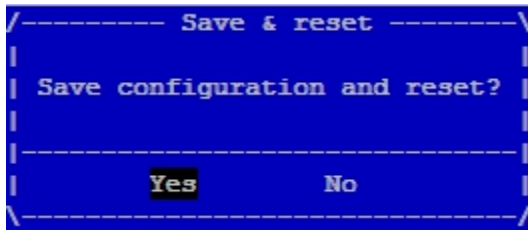

Restore Defaults

Restore default values for all setup options. Select "**Yes**" to load Optimized defaults.

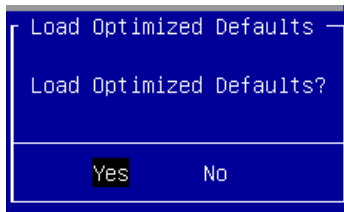



Note

The items under Boot Override were not same with image. It should depend on devices connect on system.

APPENDIX A: LED INDICATOR EXPLANATIONS

The status explanations of LED indicators on Front Panel are as follows:

-  System Power
-  System Status
-  HDD Activity

► **System Power**

<i>Solid Green</i>	<i>The system is powered on</i>
<i>Off</i>	<i>The system is powered off</i>

► **System Status**

This LED indicator is programmable. You could program it to display the operating status of the behaviors described below:

<i>Solid Green</i>	<i>Defined by GPIO</i>
<i>Solid Red</i>	<i>Defined by GPIO</i>
<i>Off</i>	<i>Defined by GPIO</i>

► **HDD Activity**

If this LED blinks, it indicates data access activities; otherwise, it remains off.

<i>Blinking Amber</i>	<i>Data access activity</i>
<i>Off</i>	<i>No data access activity</i>

Link Activity  Speed
RJ45 Port

► **Link Activity**

<i>Blinking Amber</i>	<i>Link has been established and there is activity on this port</i>
<i>Solid Amber</i>	<i>Link has been established and there is no activity on this port</i>
<i>Off</i>	<i>No link is established</i>

► **Speed**

<i>Solid Amber</i>	<i>Operating as a Gigabit connection (1000 Mbps)</i>
<i>Solid Green</i>	<i>Operating as a 100-Mbps connection</i>
<i>Off</i>	<i>Operating as a 10-Mbps connection</i>

Link Activity  Speed
SPF+ Port

► **Link Activity**

<i>Blinking Green</i>	<i>Link has been established and there is activity on this port</i>
<i>Solid Green</i>	<i>Link has been established and there is no activity on this port</i>
<i>Off</i>	<i>No link is established</i>

► **Speed**

<i>Solid Green</i>	<i>Operating as 10 Gigabit connection</i>
<i>Solid Amber</i>	<i>Operating as a Gigabit connection</i>
<i>Off</i>	<i>Operating as a 100 Mbps connection</i>

APPENDIX B: DUAL BIOS INTRODUCTION

Why Dual BIOS?

Failure of booting up BIOS is not uncommon to most experienced users, yet it can be the worst nightmare. This occurs mostly during a power failure or a mishandled BIOS update, after a malware's attack that corrupted the data on the chip, or, at worst, due to physical damage that caused the BIOS not to function. When it happens, not merely will the recovering procedures consume considerable time and effort, but all your work might also be to no avail. Eventually, you are left with no choice but to ship the board back to the manufacturer.

Lanner understands this pain and has empowered our products with the Dual BIOS feature. Normally, the Primary BIOS is used to boot the OS during powering up; when Primary BIOS is down, the Recovery BIOS automatically jumps in to boot up the OS for the User to take further steps such as performing data backup and BIOS upgrade.

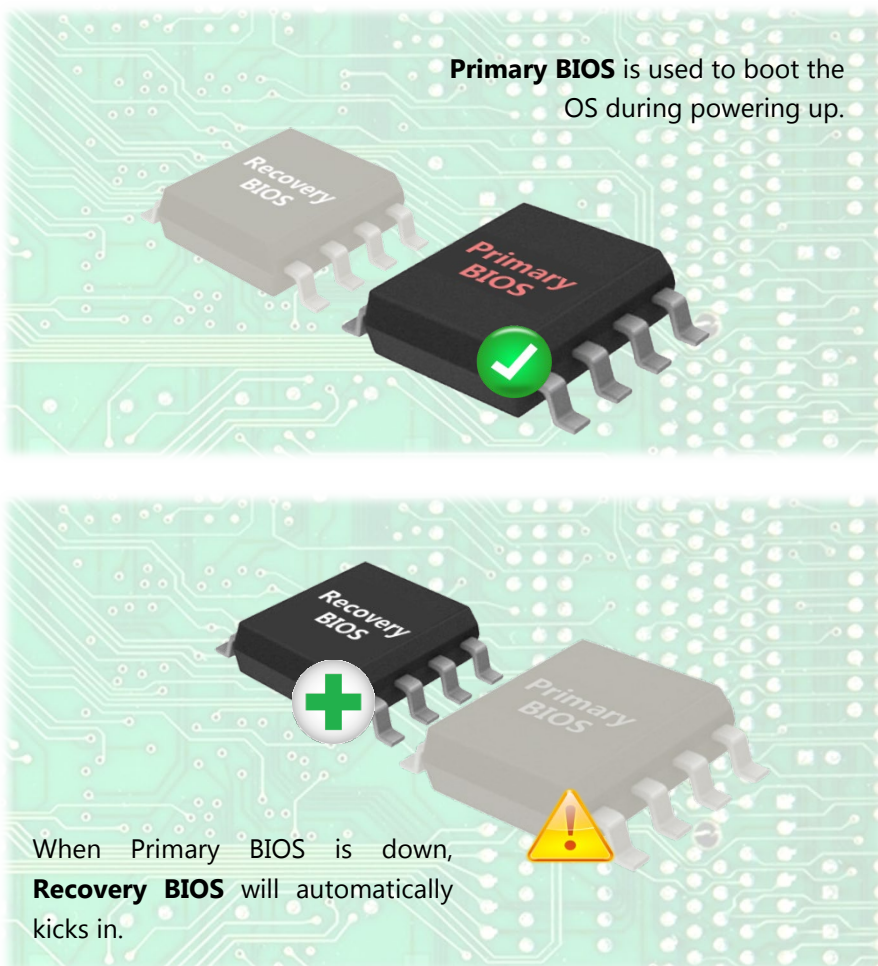

Addressing BIOS Start-up Failure with Dual BIOS

Few things can shut down a computer as completely as a corrupted BIOS. With Dual BIOS feature, you will be guaranteed to enter a healthy OS to perform thorough troubleshooting before the situation is irreparable.

How Dual BIOS Works

Dual BIOS features two physical BIOS ROMs soldered onto the motherboard, carrying two separate BIOS images. The Primary BIOS carries the image for system bootup, the parameters of which can be overwritten, while the Recovery BIOS carries the image locked to the factory default, which guarantees a safe and successful system bootup. If the Primary BIOS is not functioning correctly and fails to respond within 7 minutes, the system will invoke a bootup from the Recovery BIOS, automatically restart the system and launch the operating system.

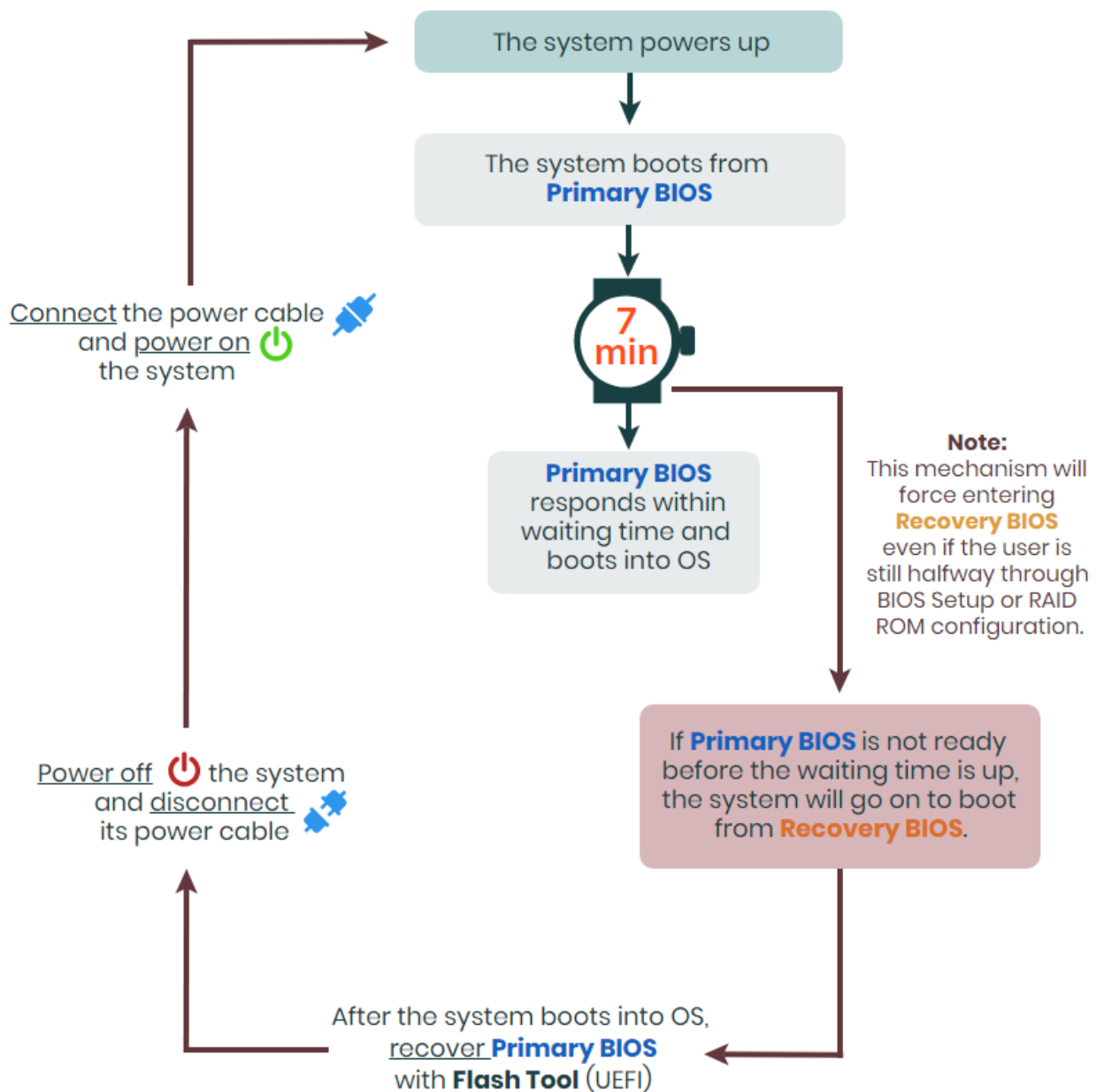

How do I know which BIOS the system is booting from?

On POST screen, the **Boot Bios** information will display the BIOS used for this bootup.



I just found the system being booted from the Recovery BIOS, what's next?

With the Recovery BIOS at work, it can be asserted that the Primary BIOS is having such severe problem that it failed to function. Before you make certain the BIOS chip is completely corrupted, it is definitely sensible to try the last resort—updating BIOS.

Get Ready for BIOS Update

Flashing a corrupted BIOS can never be taken lightly, for once done wrongly, it is almost certain to lead to an unusable system. To get ready for a BIOS update, acquire the following BIOS resources from Lanner technical support:

- Firmware and Flash Tool
- BIOS Engineering Spec
- Release Note

Before you start, make sure you select the correct firmware version and go through the instructions for BIOS update in *BIOS Engineering Spec* and BIOS fix information in the *Release Note* thoroughly. If you cannot be certain if this version is correct for your system, please contact Lanner Technical Support.

Disclaimer

Under no circumstances will Lanner accept responsibility or liability for damages of any kind whatsoever resulting or arising directly or indirectly from a BIOS update.



Warning

DO NOT power off or reset the system during BIOS updating process.

APPENDIX C: TERMS AND CONDITIONS

Warranty Policy

1. All products are under warranty against defects in materials and workmanship for a period of one year from the date of purchase.
2. The buyer will bear the return freight charges for goods returned for repair within the warranty period; whereas the manufacturer will bear the after service freight charges for goods returned to the user.
3. The buyer will pay for the repair (for replaced components plus service time) and transportation charges (both ways) for items after the expiration of the warranty period.
4. If the RMA Service Request Form does not meet the stated requirement as listed on "RMA Service," RMA goods will be returned at customer's expense.
5. The following conditions are excluded from this warranty:
 - ▶ Improper or inadequate maintenance by the customer
 - ▶ Unauthorized modification, misuse, or reversed engineering of the product
 - ▶ Operation outside of the environmental specifications for the product.

RMA Service

Requesting an RMA#

1. To obtain an RMA number, simply fill out and fax the "RMA Request Form" to your supplier.
2. The customer is required to fill out the problem code as listed. If your problem is not among the codes listed, please write the symptom description in the remarks box.
3. Ship the defective unit(s) on freight prepaid terms. Use the original packing materials when possible.
4. Mark the RMA# clearly on the box.



Note

Customer is responsible for shipping damage(s) resulting from inadequate/loose packing of the defective unit(s). All RMA# are valid for 30 days only; RMA goods received after the effective RMA# period will be rejected. Your computer will reboot during restart in order to change State of the Device.

RMA Service Request Form

When requesting RMA service, please fill out the following form. Without this form enclosed, your RMA cannot be processed.

RMA No:	Reasons to Return: <input type="checkbox"/> Repair(Please include failure details) <input type="checkbox"/> Testing Purpose
Company:	Contact Person:
Phone No.	Purchased Date:
Fax No.:	Applied Date:
Return Shipping Address: _____	
Shipping by: <input type="checkbox"/> Air Freight <input type="checkbox"/> Sea <input type="checkbox"/> Express _____	
<input type="checkbox"/> Others: _____	

Item	Model Name	Serial Number	Configuration

Item	Problem Code	Failure Status

***Problem Code:**

- | | | | |
|------------------------|------------------------------|--------------------|--------------------------|
| 01: D.O.A. | 07: BIOS Problem | 13: SCSI | 19: DIO |
| 02: Second Time R.M.A. | 08: Keyboard Controller Fail | 14: LPT Port | 20: Buzzer |
| 03: CMOS Data Lost | 09: Cache RMA Problem | 15: PS2 | 21: Shut Down |
| 04: FDC Fail | 10: Memory Socket Bad | 16: LAN | 22: Panel Fail |
| 05: HDC Fail | 11: Hang Up Software | 17: COM Port | 23: CRT Fail |
| 06: Bad Slot | 12: Out Look Damage | 18: Watchdog Timer | 24: Others (Pls specify) |

Request Party

Confirmed By Supplier

Authorized Signature / Date

Authorized Signature / Date