

Lanner

Network Appliance Platforms

Hardware Platforms for Network Computing

NCA-4010 User Manual

Version: 1.9

Date of Release: 2025-04-25

About This Document



This manual describes the overview of the various functionalities of this product, and the information you need to get it ready for operation. It is intended for those who are:

- responsible for installing, administering and troubleshooting this system or Information Technology professionals.
- assumed to be qualified in the servicing of computer equipment, such as professional system integrators, or service personnel and technicians.

The latest version of this document can be found on Lanner’s official website, available either through the product page or through the [Lanner Download Center](#) page with a login account and password.

Icon Description

The icons are used in the manual to serve as an indication of interest topics or important messages.

Icon	Usage
 Note or Information	This mark indicates that there is something you should pay special attention to while using the product.
 Warning or Important	This mark indicates that there is a caution or warning and it is something that could damage your property or product.

Online Resources

To obtain additional documentation resources and software updates for your system, please visit the [Lanner Download Center](#). As certain categories of documents are only available to users who are logged in, please be registered for a Lanner Account at <http://www.lannerinc.com/> to access published documents and downloadable resources.

Technical Support

In addition to contacting your distributor or sales representative, you could submit a request at our [Lanner Technical Support](#) and fill in a support ticket to our technical support department.

Documentation Feedback

Your feedback is valuable to us, as it will help us continue to provide you with more accurate and relevant documentation. To provide any feedback, comments or to report an error, please email contact@lannerinc.com. Thank you for your time.

Copyright and Trademarks

This document is copyrighted © 2025 by Lanner Electronics Inc. All rights are reserved. The original manufacturer reserves the right to make improvements to the products described in this manual at any time without notice. No part of this manual may be reproduced, copied, translated or transmitted in any form or by any means without the prior written permission of the original manufacturer. Information provided in this manual is intended to be accurate and reliable. However, the original manufacturer assumes no responsibility for its use, nor for any infringements upon the rights of third parties that may result from such use.

Contact Information

Taiwan Corporate Headquarters

Lanner Electronics Inc.

7F, No.173, Sec.2, Datong Rd.
Xizhi District, New Taipei City 22184,
Taiwan

立端科技股份有限公司

221 新北市汐止區
大同路二段 173 號 7 樓

T: +886-2-8692-6060

F: +886-2-8692-6101

E: contact@lannerinc.com

USA

Lanner Electronics Inc.

47790 Westinghouse Drive
Fremont, CA 94539

T: +1-855-852-6637

F: +1-510-979-0689

E: sales_us@lannerinc.com

Europe

Lanner Europe B.V.

Wilhelmina van Pruisenweg 104
2595 AN The Hague
The Netherlands

T: +31 70 701 3256

E: sales_eu@lannerinc.com

China

Beijing L&S Lancom Platform Tech. Co., Ltd.

Guodong LOFT 9 Layer No. 9 Huinan Road,
Huilongguan Town, Changping District, Beijing
102208 China

T: +86 010-82795600

F: +86 010-62963250

E: service@ls-china.com.cn

Canada

Lanner Electronics Canada Ltd

3160A Orlando Drive
Mississauga, ON
L4V 1R5 Canada

T: +1 877-813-2132

F: +1 905-362-2369

E: sales_ca@lannerinc.com

Acknowledgement

Intel, Pentium and Celeron are registered trademarks of Intel Corp. Microsoft Windows and MS-DOS are registered trademarks of Microsoft Corp. All other product names or trademarks are properties of their respective owners.

Federal Communication Commission Interference Statement

This equipment has been tested and found to comply with the limits for a Class A digital device, pursuant to Part 15 of FCC Rules. These limits are designed to provide reasonable protection against harmful interference in a residential installation. This equipment generates, uses and can radiate radio frequency energy and, if not installed and used in accordance with the instruction, may cause harmful interference to radio communications. However, there is no guarantee that interference will not occur in a particular installation. If this equipment does cause harmful interference to radio or television reception, which can be determined by turning the equipment off and on, the user is encouraged to try to correct the interference by one or more of the following measures:

- ▶ Reorient or relocate the receiving antenna.
- ▶ Increase the separation between the equipment and receiver.
- ▶ Connect the equipment into an outlet on a circuit different from that to which the receiver is connected.
- ▶ Consult the dealer or an experienced radio/TV technician for help.

FCC Caution

- ▶ Any changes or modifications not expressly approved by the party responsible for compliance could void the user's authority to operate this equipment.
- ▶ This transmitter must not be co-located or operating in conjunction with any other antenna or transmitter.



Note

1. An unshielded-type power cord is required in order to meet FCC emission limits and also to prevent interference to the nearby radio and television reception. It is essential that only the supplied power cord be used.
2. Use only shielded cables to connect I/O devices to this equipment.
3. Changes or modifications not expressly approved by the party responsible for compliance could void the user's authority to operate the equipment.



Important

1. Operations in the 5.15-5.25GHz band are restricted to indoor usage only.
2. This device meets all the other requirements specified in Part 15E, Section 15.407 of the FCC Rules.

Safety Guidelines

Follow these guidelines to ensure general safety:

- ▶ Keep the chassis area clear and dust-free during and after installation.
- ▶ Do not wear loose clothing or jewelry that could get caught in the chassis. Fasten your tie or scarf and roll up your sleeves.
- ▶ Wear safety glasses if you are working under any conditions that might be hazardous to your eyes.
- ▶ Do not perform any action that creates a potential hazard to people or makes the equipment unsafe.
- ▶ Disconnect all power by turning off the power and unplugging the power cord before installing or removing a chassis or working near power supplies
- ▶ Do not work alone if potentially hazardous conditions exist.
- ▶ Never assume that power is disconnected from a circuit; always check the circuit.

Consignes de sécurité

Suivez ces consignes pour assurer la sécurité générale:

- ▶ Laissez la zone du châssis propre et sans poussière pendant et après l'installation.
- ▶ Ne portez pas de vêtements amples ou de bijoux qui pourraient être pris dans le châssis. Attachez votre cravate ou écharpe et remontez vos manches.
- ▶ Portez des lunettes de sécurité pour protéger vos yeux.
- ▶ N'effectuez aucune action qui pourrait créer un danger pour d'autres ou rendre l'équipement dangereux.
- ▶ Coupez complètement l'alimentation en éteignant l'alimentation et en débranchant le cordon d'alimentation avant d'installer ou de retirer un châssis ou de travailler à proximité de sources d'alimentation.
- ▶ Ne travaillez pas seul si des conditions dangereuses sont présentes.
- ▶ Ne considérez jamais que l'alimentation est coupée d'un circuit, vérifiez toujours le circuit. Cet appareil génère, utilise et émet une énergie radiofréquence et, s'il n'est pas installé et utilisé conformément aux instructions des fournisseurs de composants sans fil, il risque de provoquer des interférences dans les communications radio.

Lithium Battery Caution

- ▶ There is risk of explosion if the battery is replaced by an incorrect type.
- ▶ Dispose of used batteries according to the instructions.
- ▶ Installation should be conducted only by a trained electrician or only by an electrically trained person who knows all installation procedures and device specifications which are to be applied.
- ▶ Do not carry the handle of power supplies when moving to another place.
- ▶ Please conform to your local laws and regulations regarding safe disposal of lithium battery.
- ▶ Disposal of a battery into fire or a hot oven, or mechanically crushing or cutting of a battery can result in an explosion.
- ▶ Leaving a battery in an extremely high temperature environment can result in an explosion or the leakage of flammable liquid or gas.
- ▶ A battery subjected to extremely low air pressure may result in an explosion or the leakage of flammable liquid or gas.

Avertissement concernant la pile au lithium

- ▶ Risque d'explosion si la pile est remplacée par une autre d'un mauvais type.
- ▶ Jetez les piles usagées conformément aux instructions.
- ▶ L'installation doit être effectuée par un électricien formé ou une personne formée à l'électricité connaissant toutes les spécifications d'installation et d'appareil du produit.
- ▶ Ne transportez pas l'unité en la tenant par le câble d'alimentation lorsque vous déplacez l'appareil.

Operating Safety

- ▶ Electrical equipment generates heat. Ambient air temperature may not be adequate to cool equipment to acceptable operating temperatures without adequate circulation. Be sure that the room in which you choose to operate your system has adequate air circulation.
- ▶ Ensure that the chassis cover is secure. The chassis design allows cooling air to circulate effectively. An open chassis permits air leaks, which may interrupt and redirect the flow of cooling air from internal components.
- ▶ Electrostatic discharge (ESD) can damage equipment and impair electrical circuitry. ESD damage occurs when electronic components are improperly handled and can result in complete or intermittent failures. Be sure to follow ESD-prevention procedures when removing and replacing components to avoid these problems.

- ▶ Wear an ESD-preventive wrist strap, ensuring that it makes good skin contact. If no wrist strap is available, ground yourself by touching the metal part of the chassis.
- ▶ Periodically check the resistance value of the antistatic strap, which should be between 1 and 10 megohms (Mohms).

Sécurité de fonctionnement

- ▶ L'équipement électrique génère de la chaleur. La température ambiante peut ne pas être adéquate pour refroidir l'équipement à une température de fonctionnement acceptable sans circulation adaptée. Vérifiez que votre site propose une circulation d'air adéquate.
- ▶ Vérifiez que le couvercle du châssis est bien fixé. La conception du châssis permet à l'air de refroidissement de bien circuler. Un châssis ouvert laisse l'air s'échapper, ce qui peut interrompre et rediriger le flux d'air frais destiné aux composants internes.
- ▶ Les décharges électrostatiques (ESD) peuvent endommager l'équipement et gêner les circuits électriques. Des dégâts d'ESD surviennent lorsque des composants électroniques sont mal manipulés et peuvent causer des pannes totales ou intermittentes. Suivez les procédures de prévention d'ESD lors du retrait et du remplacement de composants.
- ▶ Portez un bracelet anti-ESD et veillez à ce qu'il soit bien au contact de la peau. Si aucun bracelet n'est disponible, reliez votre corps à la terre en touchant la partie métallique du châssis.
- ▶ Vérifiez régulièrement la valeur de résistance du bracelet antistatique, qui doit être comprise entre 1 et 10 mégohms (Mohms).

Mounting Installation Precautions

The following should be put into consideration for rack-mount or similar mounting installations:

- ▶ Do not install and/or operate this unit in any place that flammable objects are stored or used in.
- ▶ The installation of this product must be performed by trained specialists; otherwise, a non-specialist might create the risk of the system's falling to the ground or other damages.
- ▶ Lanner Electronics Inc. shall not be held liable for any losses resulting from insufficient strength for supporting the system or use of inappropriate installation components.
- ▶ Elevated Operating Ambient - If installed in a closed or multi-unit rack assembly, the operating ambient temperature of the rack environment may be greater than room ambient. Therefore, consideration should be given to installing the equipment in an environment compatible with the maximum ambient temperature (T_{ma}) specified by the manufacturer.
- ▶ Reduced Air Flow - Installation of the equipment in a rack should be such that the amount of airflow required for safe operation of the equipment is not compromised.
- ▶ Mechanical Loading - Mounting of the equipment in the rack should be such that a hazardous condition is not achieved due to uneven mechanical loading.
- ▶ Circuit Overloading - Consideration should be given to the connection of the equipment to the supply circuit and the effect that overloading of the circuits might have on overcurrent protection and supply wiring. Appropriate consideration of equipment nameplate ratings should be used when addressing this concern.
- ▶ Reliable Grounding - Reliable grounding of rack mounted equipment should be maintained. Particular attention should be given to supply connections other than direct connections to the branch circuit (e.g. use of power strips).
- ▶ Instruction for the installation of the conductor to building earth by a skilled person.

Electrical Safety Instructions

Before turning on the device, ground the grounding cable of the equipment. Proper grounding (grounding) is very important to protect the equipment against the harmful effects of external noise and to reduce the risk of electrocution in the event of a lightning strike. To uninstall the equipment, disconnect the ground wire after turning off the power. A ground wire (green-and-yellow) is required and the part connecting the conductor must be greater than 6 mm² or 8AWG.

Consignes de sécurité électrique

- ▶ Avant d'allumer l'appareil, reliez le câble de mise à la terre de l'équipement à la terre.
- ▶ Une bonne mise à la terre (connexion à la terre) est très importante pour protéger l'équipement contre les effets néfastes du bruit externe et réduire les risques d'électrocution en cas de foudre.
- ▶ Pour désinstaller l'équipement, débranchez le câble de mise à la terre après avoir éteint l'appareil.
- ▶ Un câble de mise à la terre est requis et la zone reliant les sections du conducteur doit faire plus de 6 mm² ou 8 AWG.

Table of Contents

Chapter 1: Introduction	8
Package Content	8
Ordering Information	9
Optional Accessories	9
System Specifications.....	10
Chapter 2: System Overview	11
Mechanical Drawing	11
Block Diagram	12
Front I/Os	13
Rear I/Os	14
Chapter 3: Board Layout	15
Jumpers and Connectors on the Motherboard.....	15
Jumper Setting and Connector Pin-out	16
Chapter 4: Hardware Setup	28
Preparing the Hardware Installation.....	28
About the CPU, Heatsink and Heat-Radiation Bracket.....	29
Installing the System Memory	30
Installing Disk Drives.....	31
Installing a mSATA Module	33
Installing an IPMI Card (Project-based).....	34
Replacing Cooling Fans	35
Installing Ethernet NIC Modules.....	36
Rackmount Installation	38
Chapter 5: BIOS Setup	42
Main	43
Advanced	44
IntelRCSetup	64
Security	78
Boot	79
Save & Exit.....	82
Appendix A: Programming Watchdog Timer	88
Appendix B: Setting up Console Redirection	89
Appendix C: Programming Generation 3 LAN Bypass.....	90
Appendix D: Programming the LCM.....	91
Appendix E: Terms and Conditions	95

Chapter 1: Introduction

Thank you for choosing NCA-4010. The NCA-4010 series unit is a 1U Rack mount network security system utilizing the cutting-edge capabilities of the Intel Broadwell-DE SoC. The system supports up to 8/16x port RJ45 GBE, 2x 10G SFP+ ports (optional), 1x NIC module, 1x 3.5" / 2 x 2.5" SATA disk drive kit, 1x OPMA socket for IPMI and 1x mSATA socket. For network reliability, NCA-4010 supports 3 or 7 pairs of LAN bypass depending on the SKU selection.

Main Features:

- ▶ Intel® Xeon® processor D-1518/D-1548 with BGA package
- ▶ 8/16 GbE LAN ports and 2 x SFP+ 10G ports (vary depending on models)
- ▶ LAN bypass: 3 or 7 pairs of LAN bypass (vary depending on models)
- ▶ 1 x NIC module slots support 40G/10G/1G/Fiber/Copper/Bypass
- ▶ 2 x DDR4 REG/ECC/UDIMM memory sockets at 2400 MHz (up to 16GB each)
- ▶ 1 x 3.5" or 2 x 2.5" SATA HDD/SSD drive bays (disk drive is not included)
- ▶ 1 x mSATA socket; 1 x OPMA socket for IPMI

Package Content

Your package contains the following items:

- ▶ 1x NCA-4010 Network Security Platform
- ▶ 1x LAN Cable (Grey), 1x Console Cable, 1x Power Supply Cable
- ▶ 1x Ear Rackmount Kit w/ Screws

NOTE: The supplied power cable is dedicated to this product only; do not use them with devices other than this model.

Ordering Information

SKU No.	Main Features
NCA-4010A	1U x86 Rackmount Network Appliance with Intel® Xeon® D-1548 (Codenamed Broadwell-DE) Processor, 16x GbE RJ45 with 2x 10GbE SFP+ Ports, and 1x NIC Module Slot, 7 Pairs of Bypass
NCA-4010B	1U x86 Rackmount Network Appliance with Intel® Xeon® D-1518 (Codenamed Broadwell-DE) Processor, 8x GbE RJ45 Ports, and 1x NIC Module Slot, 3 Pairs of Bypass
NCA-4010C	1U x86 Rackmount Network Appliance with Intel® Xeon® D-1548 (Codenamed Broadwell-DE) Processor, 8x GbE RJ45 Ports, and 1x NIC Module Slot, 3 Pairs of Bypass
NCA-4010D	1U x86 Rackmount Network Appliance with Intel® Xeon® D-1548 (Codenamed Broadwell-DE) Processor, 8x GbE RJ45 with 2x 10GbE SFP+ Ports, and 1x NIC Module Slot, 3 Pairs of Bypass
NCA-4010E	1U x86 Rackmount Network Appliance with Intel® Xeon® D-1548 (Codenamed Broadwell-DE) Processor, 15x GbE RJ45 with 2x SFP+ 10GbE Ports, IPMI, and 1x NIC Module Slot, 7 Pairs of Bypass
NCA-4010Y	1U Rackmount Network Appliance with Intel® Xeon® D-1548 (Codenamed Broadwell-DE) Processor, 8x GbE RJ45 with 2x 10GbE SFP+ Ports, 1x Console Port, 2x USB 2.0 Ports, 1x NIC Module Slot, 220W Single PSU, 1x TPM1.2

Optional Accessories

Model	Description
NCS2-IGM806A	2x Intel i350 8 x RJ-45 ports with 4 pairs of bypass
NCS2-ISM802A	2x Intel i350 8 x RJ-45 ports without bypass
NCS2-IXM405A	2x Intel 82599 4 x SFP+ ports without bypass
IAC-AST2300	IPMI Module Card Kit

System Specifications

Form Factor		Rackmount Network Appliance
Platform	Processor Options	Intel® Xeon® Processor D-1548 or D-1518 (Broadwell-DE) Processor
	CPU Socket	Onboard
	Chipset	SoC
	Security Acceleration	Intel® QuickAssist Technology
BIOS		AMI SPI Flash BIOS
System Memory	Technology	DDR4 2400MHz, REG, ECC or non-ECC UDIMM
	Max. Capacity	R-DIMM: 64GB; ECC: 32GB
	Socket	2x 288-pin DIMM
Networking	NIC Module Slot	1x NIC Module slot
	Ethernet Ports	8x GbE RJ45 Intel® i210; 8x GbE RJ45 Intel® i350-AM4 (By SKU); 2x 10G SFP+ Broadwell-D SoC (By SKU)
	Bypass	7x or 3x Pairs of Gen 3 Bypass (By SKU)
Storage	HDD/SSD Support	2x 2.5" Drive Bays
	Onboard Slots	1x mSATA slot
I/O Interface	Reset Button	1x Reset Button
	LCD Module	2x20 Character LCM, 4x Keypads
	Console Port	1x RJ45 Console Port
	USB Port	2x USB 2.0 Ports
	Display Output	OPMA Slot (By Project)
Expansion	PCIe	1x PCIe*8 FH/HL (Optional)
Cooling	Processor	Passive CPU Heatsink
	System	2x Cooling Fans with Smart Fan
Environment	Operating Temperature	0 °C ~ 40 °C
	Storage Temperature	-20~70°C
	Humidity (RH)	5~90% Operating, 5~ 95% Non-Operating
Miscellaneous	Watchdog	Yes
	Internal RTC w/ Li Battery	Yes
	IPMI via OPMA Slot	By Project
	TPM	Yes (By SKU)
Mechanical	Dimension (WxHxD)	438 x 44 x 321mm
	Weight	7.5kg
Package Dimensions	Dimension (WxDxH)	540 x 230 x 500mm
	Weight	8.5kg
Power	Type / Watts	220W ATX Single PSU
	Input	AC 90~ 264V @47~63Hz
Approvals and Compliance		RoHS, CE/FCC Class A, UL
Operating System		Linux Kernel 2.6 or Above, Windows 7, Windows 2008 Server

Chapter 2: System Overview

Mechanical Drawing

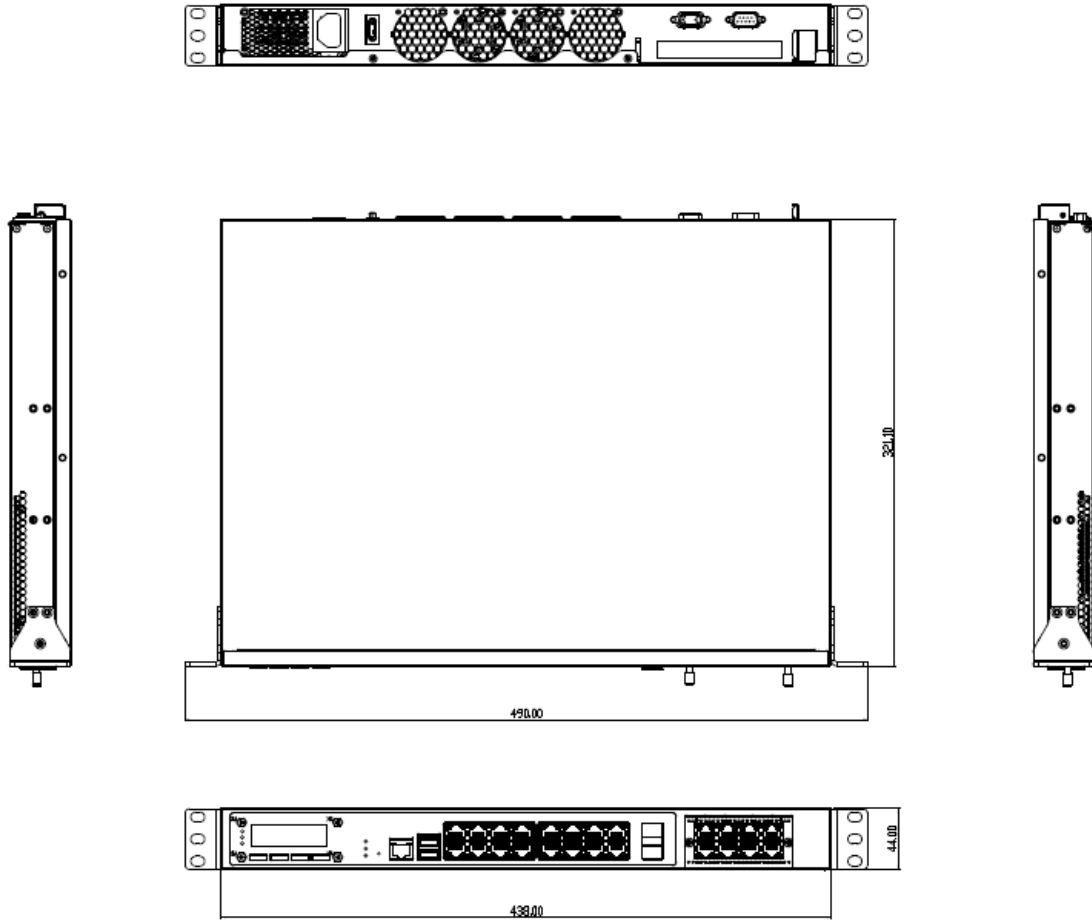

Unit: mm

Block Diagram

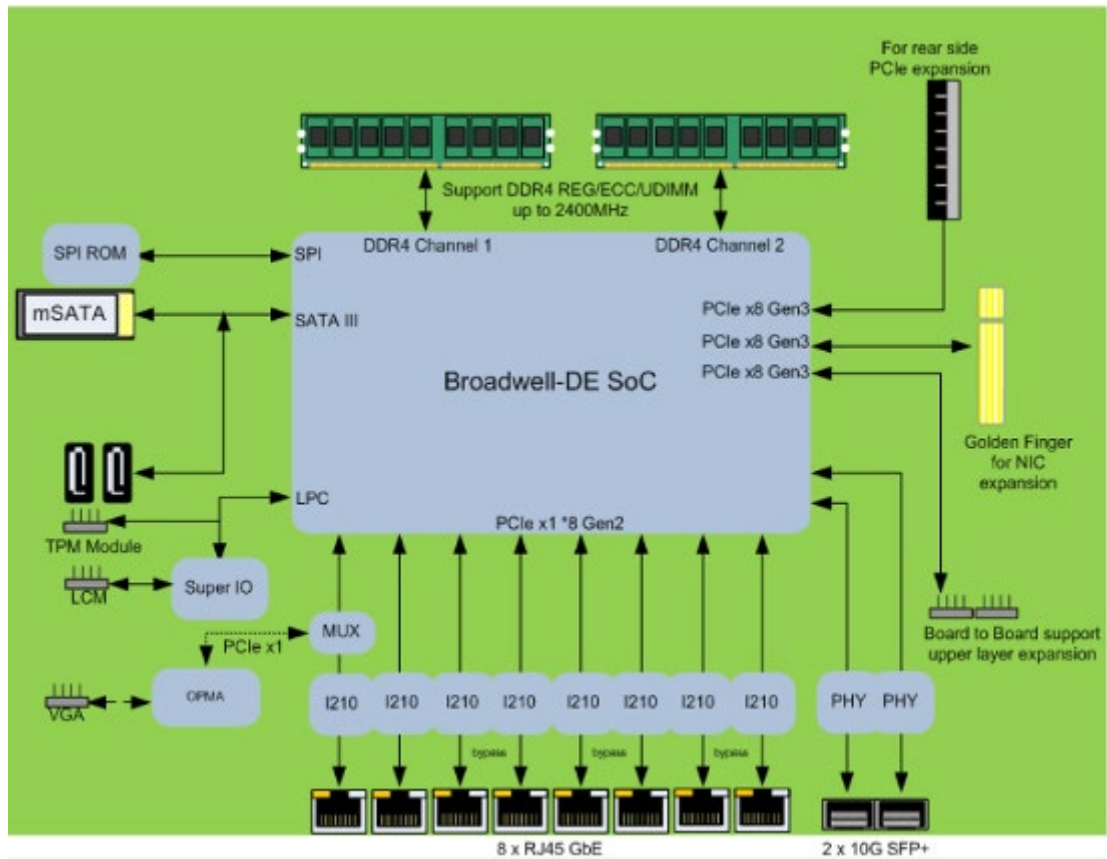

NOTE: TPM is optional. The diagram is based on 8 x RJ-45 GbE design. The number of LAN ports is 16 for model-A. The 2 x 10G SFP+ ports are only available in model A.

Front I/Os

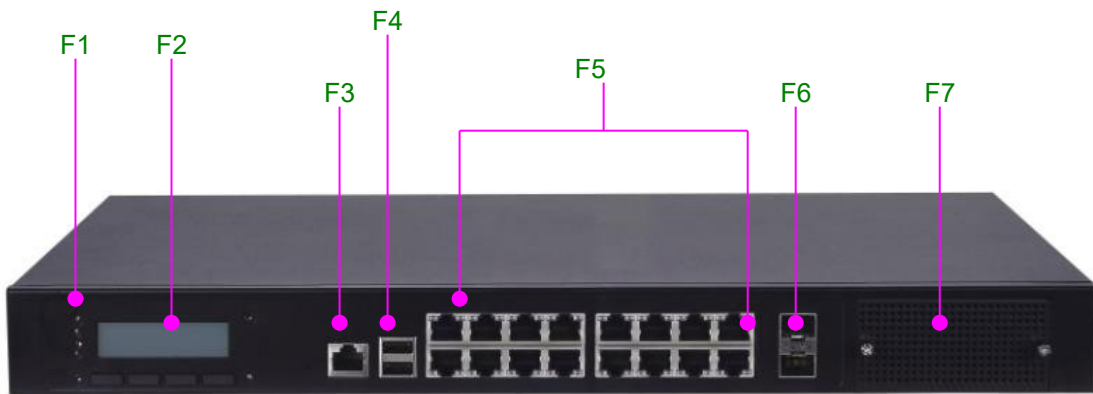

No.	Description	
F1	LED Indicators	Power/Status/Storage Status
F2	LCM Display	2x20 Character LCM, 4x Keypads
F3	Console Port	1x RJ45 Console Port
F4	USB Port	2x USB 2.0 Type A Ports
F5	LAN Ports	8x or 16x RJ45 GbE Ports (By SKU)
F6	SFP LAN Port	2x SFP+ 10G LAN Ports (By SKU)
F7	NIC Module	1x NIC Module Slot

Rear I/Os

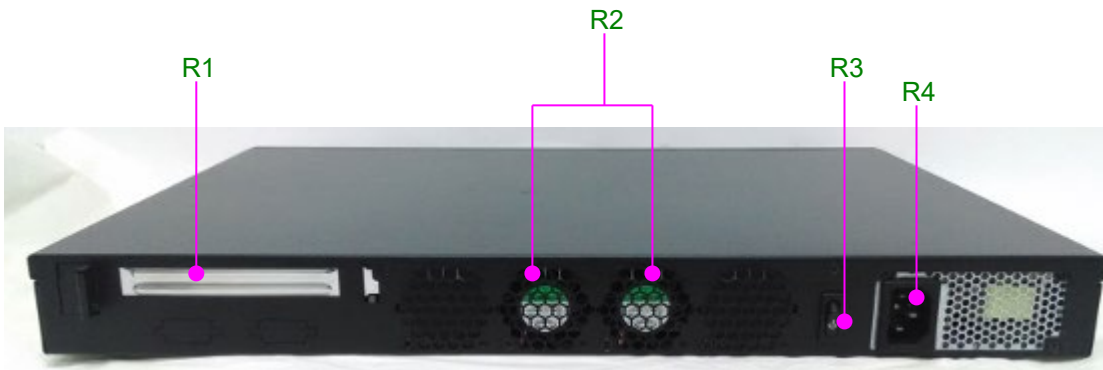

No.	Description	
R1	PCIe Expansion	1x PCIe*8 FH/HL Single-Slot Bracket (Optional)
R2	Fans	2x Smart Cooling Fans
R3	Power Switch	1x Power ON/OFF Switch
R4	Power Input	1x Power jack for Connection w/ Power Adapter

Chapter 3: Board Layout

Jumpers and Connectors on the Motherboard

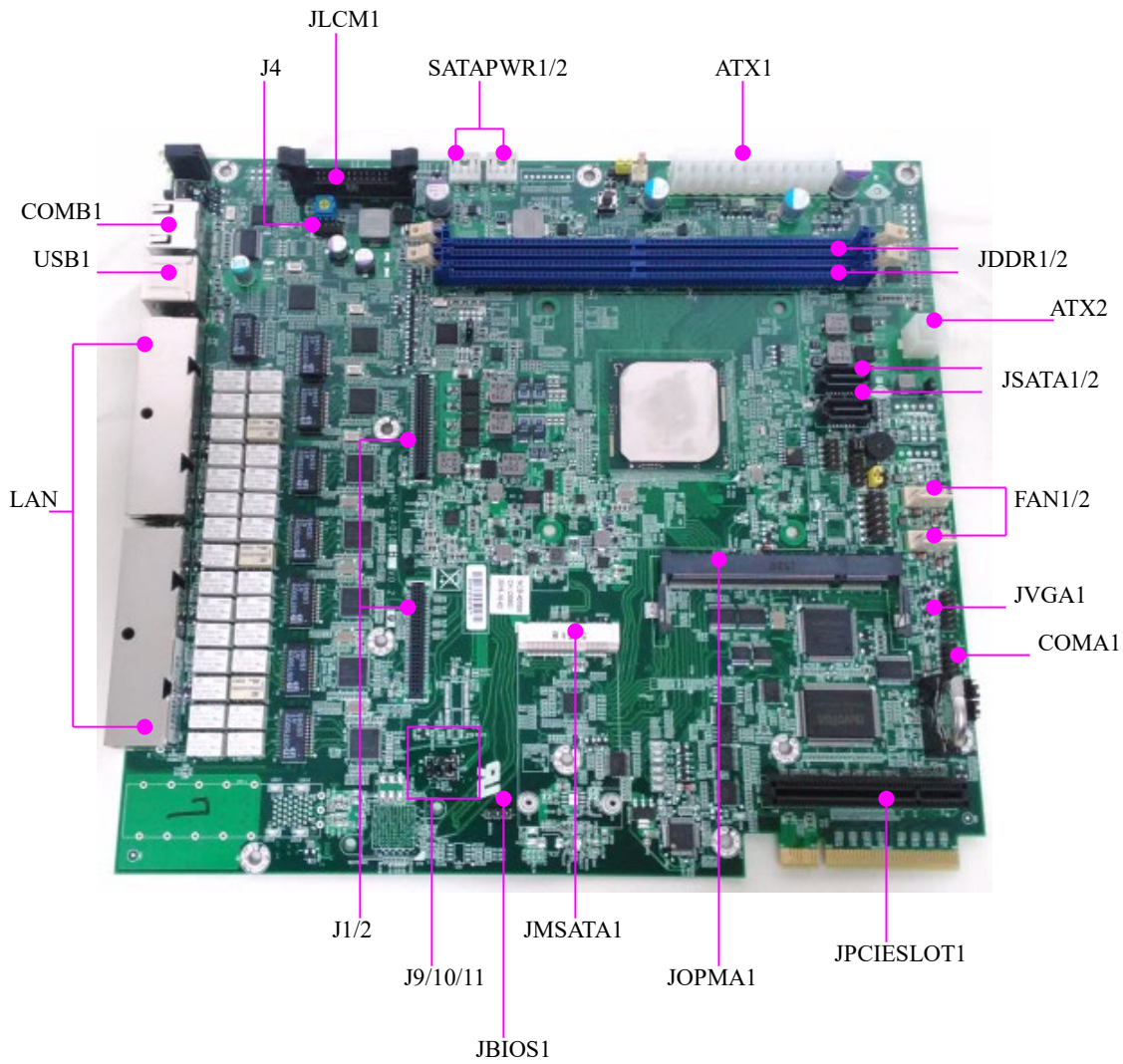

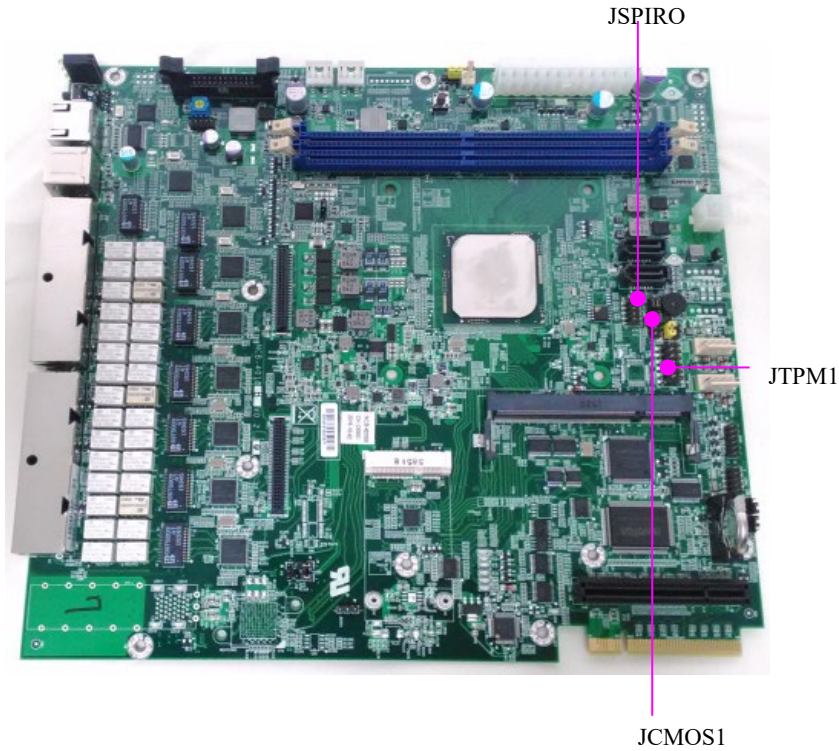

Jumper Setting and Connector Pin-out

ATX1: 24-pin ATX power connector

PIN	DESCRIPTION	PIN	DESCRIPTION
1	3.3V	2	3.3V
3	3.3V	4	-12V
5	GND	6	GND
7	5V	8	PSON#
9	GND	10	GND
11	5V	12	GND
13	GND	14	GND
15	ATXPWGD	16	-5V
17	5VSB	18	5V
19	12V	20	5V
21	12V	22	5V
23	3.3V	24	GND

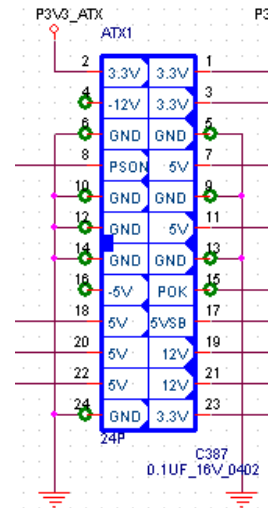

ATX2: 4-pin ATX power connector

PIN	DESCRIPTION
1	GND
2	12V
3	GND
4	12V

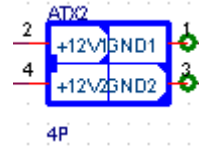

COMA1: internal serial COM pin header

PIN	DESCRIPTION	PIN	DESCRIPTION
1	NDCD2-	2	NDSR2-
3	NRXD2	4	NRTS2-
5	NTXD2	6	NCTS2-
7	NDTR2-	8	NRIZ-
9	GND	10	NC

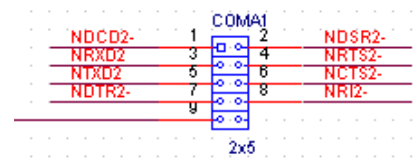

CONN2: 2-pin power connector for the power button on the panel

PIN	DESCRIPTION
1	POWER ON#
2	GND

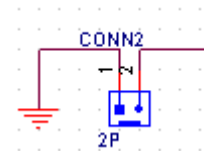

FAN1/2: 2 x 5-pin cooling fan connectors

PIN	DESCRIPTION
1	CPUFANOUTPWM
2	NC
3	CPUFANIN
4	12V
5	GND

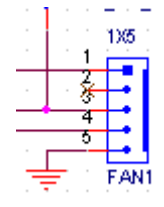

J1/2 : 2 x 50-pin I/O board connectors. NCA-4010 can be accompanied by I/O board NM-4010IG401.

J1:

PIN	DESCRIPTION	PIN	DESCRIPTION
A1	P3V3	B1	P12V
A2	P3V3	B2	P12V
A3	P3V3	B3	PCH_SLOT3_A8
A4	GND	B4	PCIESLOT3_I350A_RST#
A5	P3V3	B5	PHY_WAKE#
A6	GND	B6	GND
A7	SLT3A_SCLK2	B7	CLK100_PCIE_SOLT3_1P
A8	SLT3A_SDAT2	B8	CLK100_PCIE_SOLT3_1N
A9	GND	B9	GND
A10	IO_LAN12GND	B10	IO_LAN34GND
A11	IO_P0_S0_1	B11	IO_P1_S0_1
A12	IO_P0_S0_2	B12	IO_P1_S0_2
A13	GND	B13	GND
A14	PCIE_CTX_C_SLOT3RX_P0	B14	PCIE_SLOT3TX_C_CRX_P0
A15	PCIE_CTX_C_SLOT3RX_N0	B15	PCIE_SLOT3TX_C_CRX_N0
A16	GND	B16	GND
A17	PCIE_CTX_C_SLOT3RX_P1	B17	PCIE_SLOT3TX_C_CRX_P1
A18	PCIE_CTX_C_SLOT3RX_N1	B18	PCIE_SLOT3TX_C_CRX_N1
A19	GND	B19	GND
A20	PCIE_CTX_C_SLOT3RX_P2	B20	PCIE_SLOT3TX_C_CRX_P2
A21	PCIE_CTX_C_SLOT3RX_N2	B21	PCIE_SLOT3TX_C_CRX_N2
A22	GND	B22	GND
A23	PCIE_CTX_C_SLOT3RX_P3	B23	PCIE_SLOT3TX_C_CRX_P3
A24	PCIE_CTX_C_SLOT3RX_N3	B24	PCIE_SLOT3TX_C_CRX_N3
A25	GND	B25	GND

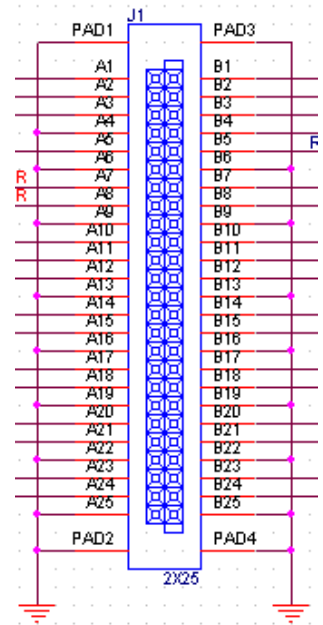

J2 :

PIN	DESCRIPTION	PIN	DESCRIPTION
A1	P3V3	B1	P12V
A2	P3V3	B2	P12V
A3	P3V3	B3	PCH_SLOT3_A8
A4	GND	B4	PCIESLOT3_I350B_RST#
A5	P3V3	B5	PHY_WAKE#
A6	GND	B6	GND
A7	SLT3B_SCLK3	B7	CLK100_PCIE_SOLT3_2P
A8	SLT3B_SDAT3	B8	CLK100_PCIE_SOLT3_2N
A9	GND	B9	GND
A10	IO_LAN56GND	B10	IO_LAN78GND
A11	IO_P2_S0_1	B11	IO_P3_S0_1
A12	IO_P2_S0_2	B12	IO_P3_S0_2
A13	GND	B13	GND
A14	PCIE_CTX_C_SLOT3RX_P4	B14	PCIE_SLOT3TX_C_CRX_P4
A15	PCIE_CTX_C_SLOT3RX_N4	B15	PCIE_SLOT3TX_C_CRX_N4
A16	GND	B16	GND
A17	PCIE_CTX_C_SLOT3RX_P5	B17	PCIE_SLOT3TX_C_CRX_P5
A18	PCIE_CTX_C_SLOT3RX_N5	B18	PCIE_SLOT3TX_C_CRX_N5
A19	GND	B19	GND
A20	PCIE_CTX_C_SLOT3RX_P6	B20	PCIE_SLOT3TX_C_CRX_P6
A21	PCIE_CTX_C_SLOT3RX_N6	B21	PCIE_SLOT3TX_C_CRX_N6
A22	GND	B22	GND
A23	PCIE_CTX_C_SLOT3RX_P7	B23	PCIE_SLOT3TX_C_CRX_P7
A24	PCIE_CTX_C_SLOT3RX_N7	B24	PCIE_SLOT3TX_C_CRX_N7
A25	GND	B25	GND

J3 : I/O board (NM-4010IG401) ARM Programming Selection

0(2-3) : Enable

1(1-2) : Disable (default)

PIN	DESCRIPTION
1	P3V3
2	IO_PIO0_1
3	GND

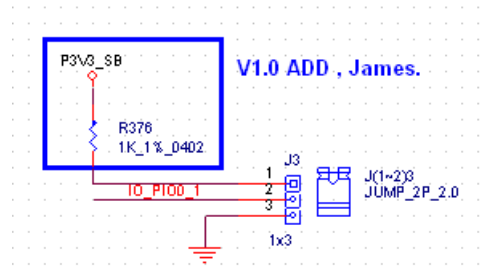

J4: Fresh I/O board (NM-4010IG401) BYPASS

PIN	DESCRIPTION	PIN	DESCRIPTION
1	NC	2	NC
3	IO_NXP_RXD	4	IO_NXP_RTS_N
5	IO_NXP_TXD	6	IO_NXP_CTS_N
7	NC	8	NC
9	GND	10	GND

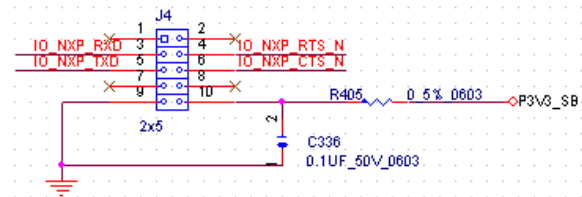

J7 : Fresh main board BYPASS

PIN	DESCRIPTION	PIN	DESCRIPTION
1	NC	2	NC
3	NXP_RXD	4	NXP_RTS_N
5	NXP_TXD	6	NXP_CTS_N
7	NC	8	NC
9	GND	10	GND

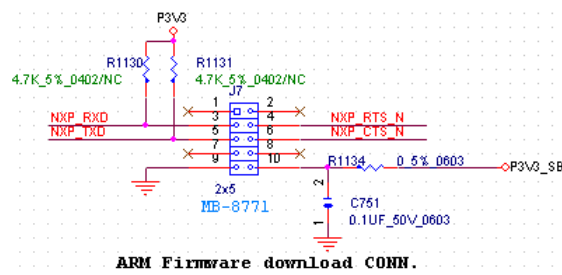

J8 : Main board ARM Programming Selection

0(2-3) : Enable

1(1-2) : Disable (default)

PIN	DESCRIPTION
1	P3V3
2	CPLD_LED3
3	GND

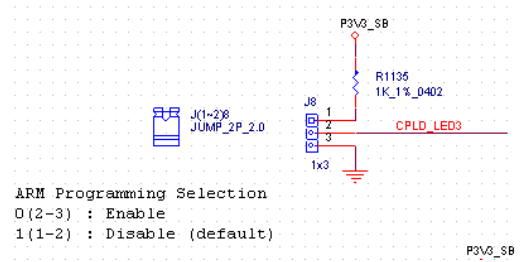

J9/J10: PHY I2C Source Selection

(2-3) : From Tool

(1-2) : From CPU (default)

J9

PIN	DESCRIPTION
1	PHY_I2C_SDA
2	PHY_I2C_SDA_JUMP
3	PHY_I2C_SDA_TOOL

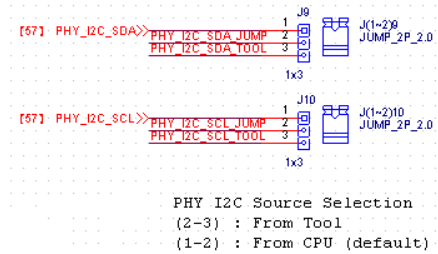

J10

PIN	DESCRIPTION
1	PHY_I2C_SCL
2	PHY_I2C_SCL_JUMP
3	PHY_I2C_SCL_TOOL

J11: PHY I2C debug pin header

PIN	DESCRIPTION
1	PHY_I2C_SDA_TOOL
2	GND
3	PHY_I2C_SCL_TOOL

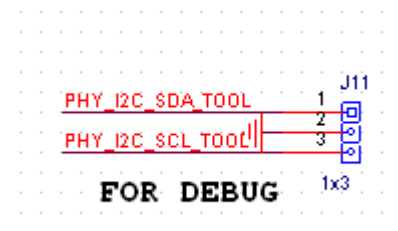

J80PORT1 : Debug Port

PIN	DESCRIPTION	PIN	DESCRIPTION
1	CLK_33M_PORT80	2	LPC_LAD1_R
3	80PORT_RST#	4	LPC_LAD0_R
5	LPC_FRAME#_P80	6	P3V3
7	LPC_LAD3_P80	8	NC
9	LPC_LAD2_P80	10	GND

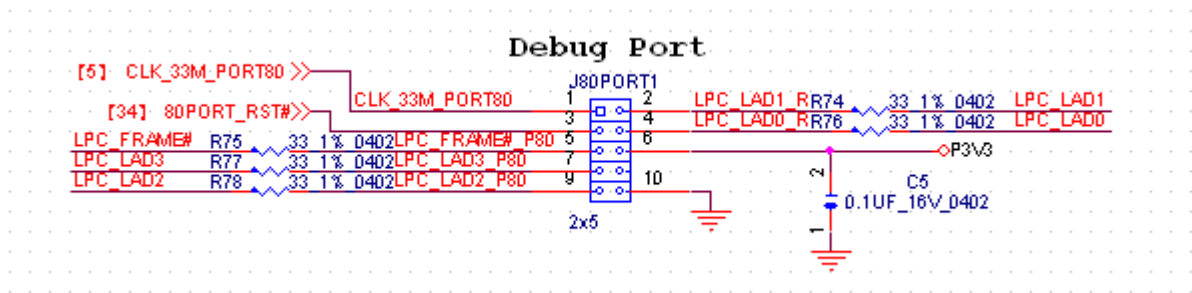

JBIOS1: PHY fresh BIOS

PIN	DESCRIPTION
1	SFFP0_EEPROM_I2C_SDA
2	GND
3	SFFP0_EEPROM_I2C_SCL

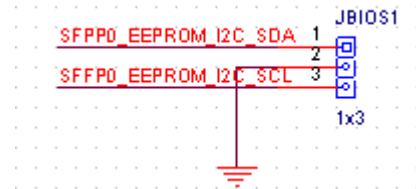

JCMOS1 : 1-2 : NORMAL

2-3 : CLEAR CMOS

PIN	DESCRIPTION
1	VCC_RTC
2	PCH_RTCRST#
3	GND

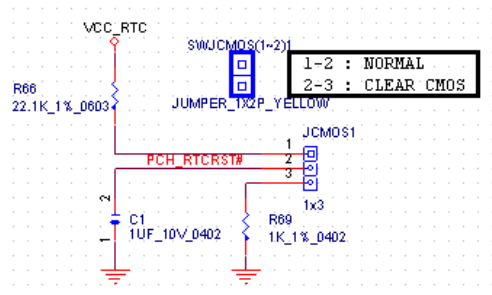

JCPLD1: Fresh CPLD (Complex Programmable Logic Device)

PIN	DESCRIPTION
1	P3V3_SB
2	DUAL_SPI_TDO
3	J_CPLD_TDI
4	CPLD_TMS
5	GND
6	CPLD_TCK

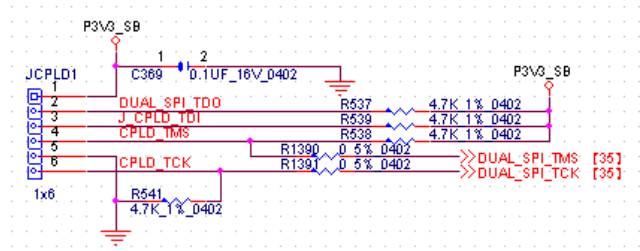

JLCM1: LCM module connector

PIN	DESCRIPTION	PIN	DESCRIPTION
1	P5V	2	GND
3	P_SLIN_N	4	VEE
5	P_AFD_N	6	P_INIT_N
7	LPD1	8	LPD0
9	LPD3	10	LPD2
11	LPD5	12	LPD4
13	LPD7	14	LPD6
15	LCD-	16	P5V
17	KPA1	18	KPA2
19	KPA3	20	KPA4
21	LCM_RST	22	CTR_GRN
23	CTR_YEW	24	HDD_LED#

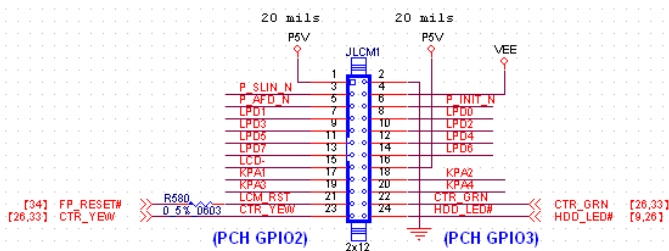

JMSATA1: mSATA module

PIN	DESCRIPTION	PIN	DESCRIPTION
1	NC	2	P3V3
3	NC	4	GND
5	NC	6	NC
7	NC	8	NC
9	GND	10	NC
11	NC	12	NC
13	NC	14	NC
15	GND	16	NC
17	NC	18	GND
19	NC	20	NC
21	GND	22	NC
23	SATA_DTX_CRX_P1	24	P3V3
25	SATA_DTX_CRX_N1	26	GND
27	GND	28	NC
29	GND	30	NC
31	SATA_CTX_C_DRX_N1	32	NC
33	SATA_CTX_C_DRX_P1	34	GND
35	GND	36	NC
37	GND	38	NC
39	P3V3	40	GND
41	P3V3	42	NC
43	GND	44	NC
45	NC	46	NC
47	NC	48	NC
49	NC	50	GND
51	NC	52	P3V3
53	GND	54	GND
55	NC	56	NC

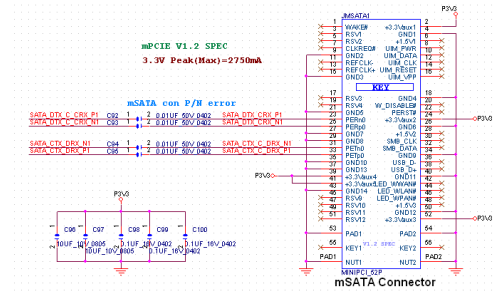

JRESET1 : Select front-panel reset option

- 1-2 Hardware Reset**
- 2-3 Software Reset (Default)**

PIN	DESCRIPTION
1	BTN_SYS_RESET#
2	FP_RESET#
3	SW_RST_GP5#

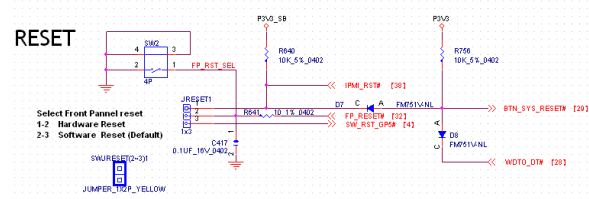

JSATA1/JSATA2 : SATA connectors for storage devices

JSATA1

PIN	DESCRIPTION
1	GND
2	SATA_CTX_C_DRX_P2
3	SATA_CTX_C_DRX_N2
4	GND
5	SATA_DTX_CRX_N2
6	SATA_DTX_CRX_P2
7	GND

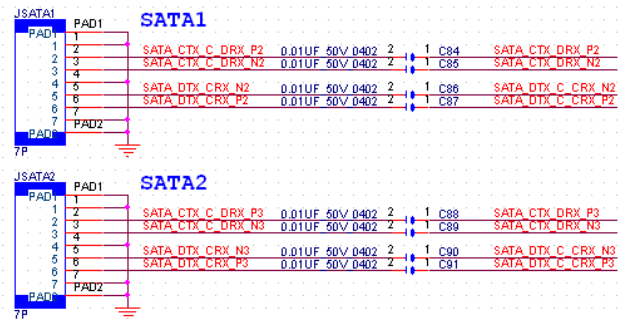

JSATA2

PIN	DESCRIPTION
1	GND
2	SATA_CTX_C_DRX_P3
3	SATA_CTX_C_DRX_N3
4	GND
5	SATA_DTX_CRX_N3
6	SATA_DTX_CRX_P3
7	GND

JSPIROM1: Fresh BIOS

PIN	DESCRIPTION	PIN	DESCRIPTION
1	SPI_HD1#	2	J_SPI2_CS0#_DUAL
3	J_SPI1_CS0#_DUAL	4	P3V3_SB
5	SPI_MISO_DUAL	6	SPI_HOLD0_L
7	NC	8	SPI_CLK_DUAL
9	GND	10	SPI_MOSI_DUAL

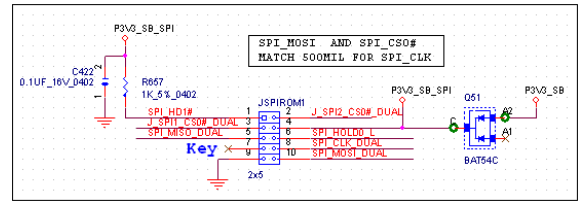

JTPM1: TPM module pin header (optional)

PIN	DESCRIPTION	PIN	DESCRIPTION
1	LPC_SERIRQ	2	LPC_FRAME#
3	LPC_LAD0	4	CLK_33M_PORT80
5	LPC_LAD1	6	P3V3_SB
7	LPC_LAD2	8	NC
9	LPC_LAD3	10	P3V3
11	PLT_RST#	12	GND

TPM

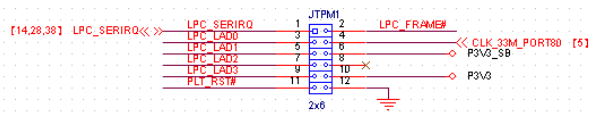

JVGA1: VGA internal connector

PIN	DESCRIPTION	PIN	DESCRIPTION
1	DAC_RO	2	GND
3	DAC_GO	4	GND
5	DAC_BO	6	GND
7	HSYNC_O	8	NC
9	VSYNC_O	10	GND
11	DDC_DATA	12	DDC_CLK

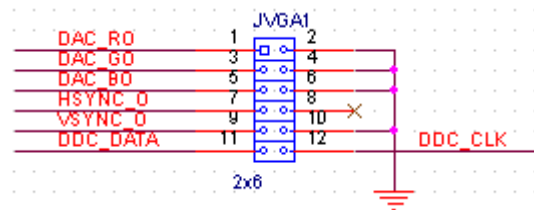

SATAPWR1/SATAPWR2: SATA 4-pin POWER connectors

PIN	DESCRIPTION
1	P12V
2	GND
3	GND
4	P5V

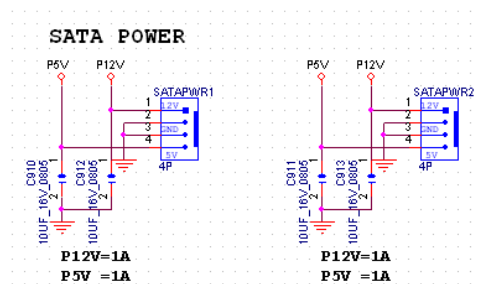

Chapter 4: Hardware Setup

Preparing the Hardware Installation

To access some components and perform certain service procedures, you must perform the following procedures first.

WARNING:

- To reduce the risk of personal injury, electric shock, or damage to the equipment, please remove all power sources.
- Please wear ESD protected gloves before conducting the following steps.

1. Power off NCA-4010 completely.
2. Remove the two screws at the rear, as circled in the figures below.



3. Slide and pull the top compartment as the arrow of direction below.



4. Lift the top compartment.

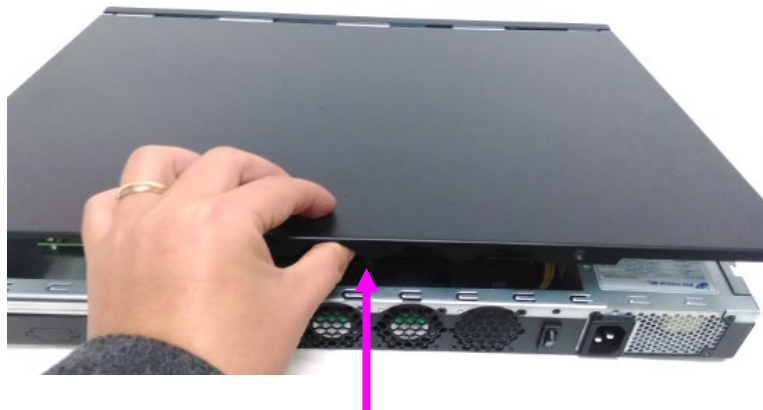

About the CPU, Heatsink and Heat-Radiation Bracket

Since the CPU is soldered onboard, the heatsink and the heat radiation brackets are pre-installed before shipment. In normal circumstances, no installation nor replacement is required. If there is any issue related to CPU overheat or damage, please contact the dealership or distributor where you purchase this appliance.

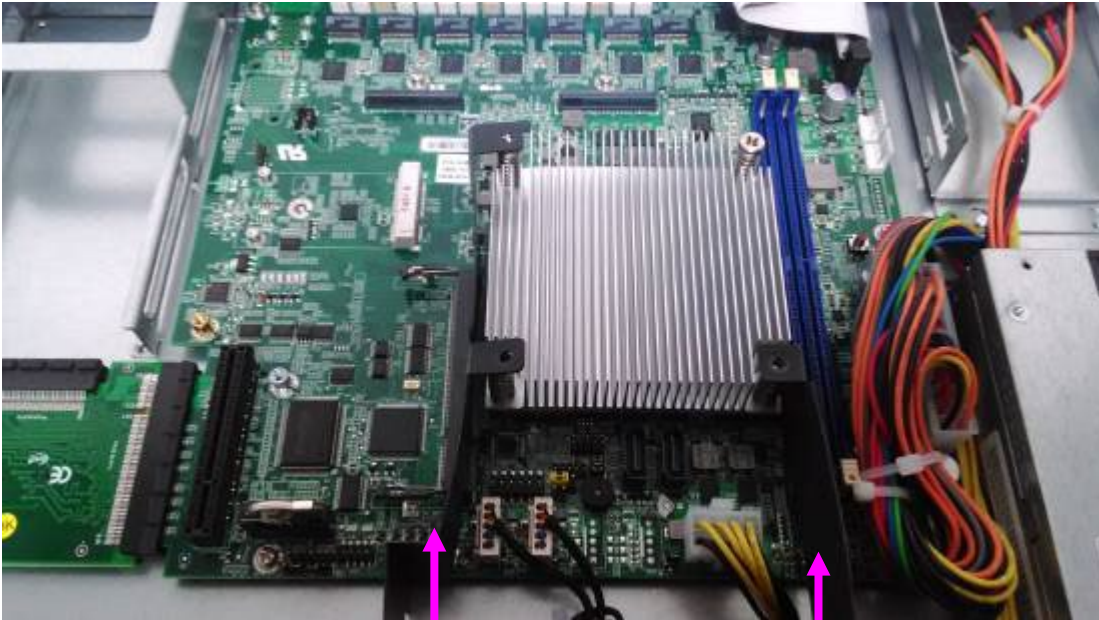

Heat radiation brackets

Installing the System Memory

The motherboard supports DDR4 RDIMM/ECC/UDIMM up to 2,400MHz memory at max. 16GB per socket. Please follow the steps below to install the DIMM memory modules.

1. Power off the system and locate the DDR DIMM slot.



2. Pull open the DIMM slot latches
3. Align the DIMM module and make sure the notches of the module aligned with the socket keys in the slot.

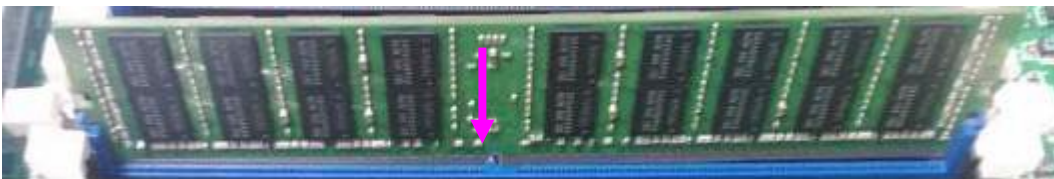

4. Insert the module into the slot until it's firmly seated and close the latches.

Installing Disk Drives (Optional)

The system supports 1 x 3.5" or 2 x 2.5" SATA HDDs or SSDs as data storage. Please follow the steps below for installation. (Note: the following steps are based on 2 x 2.5" SATA disk drives installation).

1. Locate the disk drive tray at the corner of the system.



2. Slide the tray downwards. Then the tray will be loosened from the two latching spots.



3. Take the tray out and prepare to install a SATA 2.5" disk drive.



4. Place the disk drive as shown in the image below. Apply 2 screws for each side of the disk drive.



5. Place the tray with HDD/SSD installed back to its original spot inside the system. Remember to aim the two latching holes. Then slide the tray upwards to get it locked by the two latching spots.



6. Establish SATA cable connection between the disk drive and the motherboard. Please apply 15+7 SATA cable to the drive while using SATA 7-pin connector and SATA 4-pin connector for the motherboard.



Installing a mSATA Module (Optional)

The motherboard provides one mSATA slot. Follow the procedures below for installing a mSATA card.

1. Locate the mSATA socket.



2. Insert a mSATA module as shown in the image below card.



3. Press the module down and apply two screws to secure it.



Installing an IPMI Card (Project-based/Optional)

The motherboard provides one OPMA socket which is used to install an IPMI card. Please follow the steps below for instructions.

1. Locate the OPMA socket.

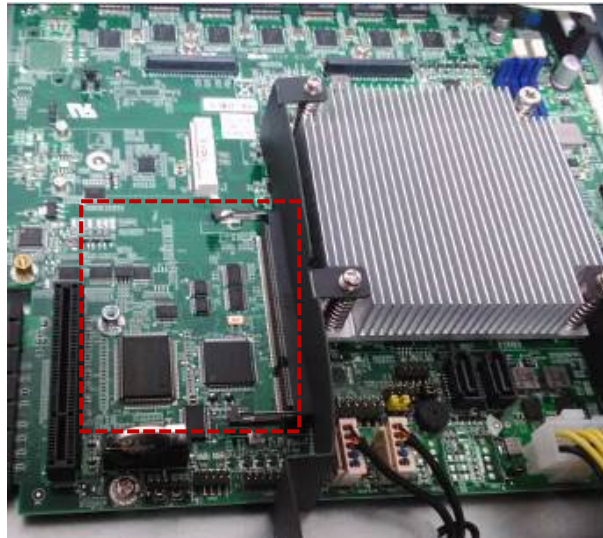

2. Insert an IPMI card into the socket and then press it down.
3. Apply a screw to secure the IPMI card.

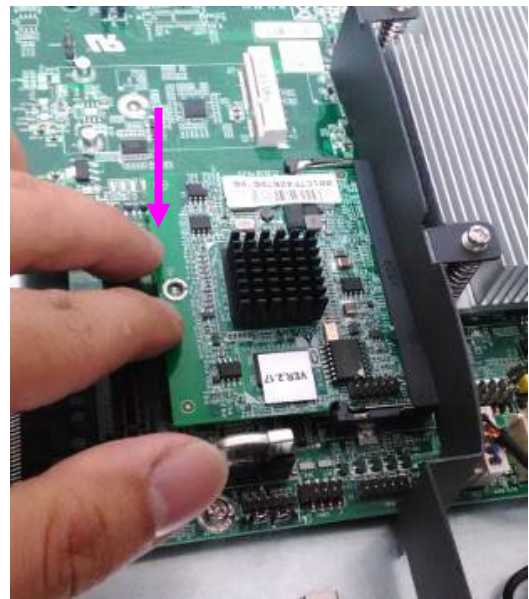

Notes: The remake about the IPMI support requires changes in BOM and it is based on custom projects. For requirements about IPMI support, please consult with Lanner representatives.

Replacing Cooling Fans

NCA-4010 supports 2 cooling fans. To replace a worn-down fan, please follow the steps below.

1. Remove the screws circled below.



2. Apply some force and pull the fan out of its original place, as shown in the image below.



3. To install a new one, just place the new fan to the original place and apply two screws.

Installing Ethernet NIC Modules (Optional)

NCA-4010 supports one Ethernet NIC module space to expand its network throughput. Please follow the instructions below.

NOTE: For information about compatible modules, please refer to the “Ordering Information” and “Optional Accessories” sections, or contact Lanner for more details.

1. Remove the two captive screws on the bezel of the module slot and open the bezel.



2. Position the gold finger of module as shown in the image below. When sliding the module into the slot, make sure the module stays in the guides of the expansion slot.





3. Slide your Ethernet NIC module into the space, until it is firmly attached.

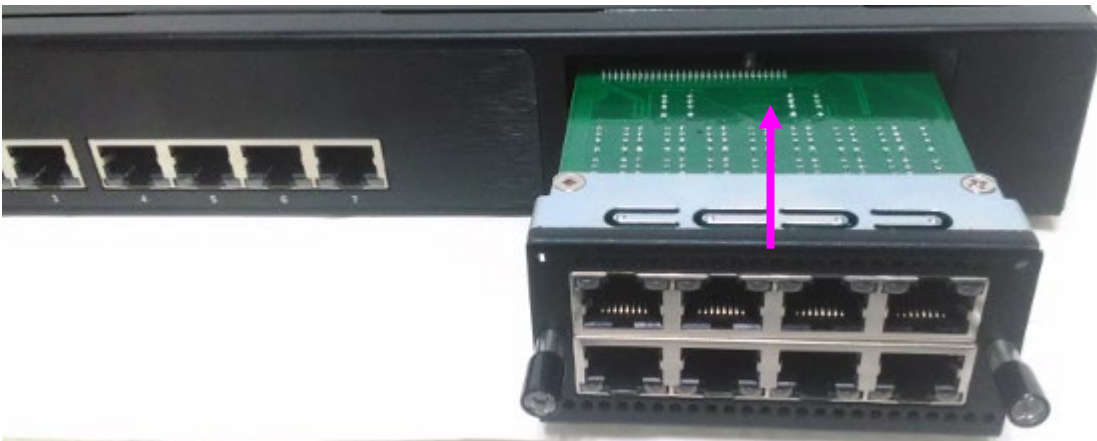

4. Secure the module with two captive screws on the bezel.



Rackmount Installation

Attach the Inner Rails

1. Check the package contents.

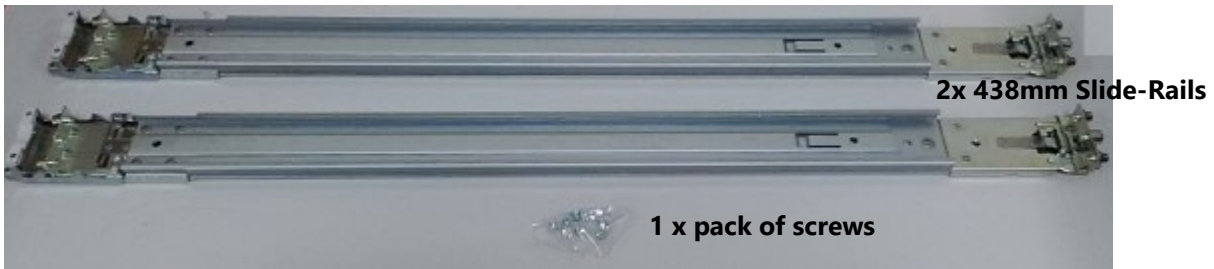

2. Turn a slide rail upside down and release the inner bracket.



4. Slide the inner bracket all the way up to end of the slide-rail assembly. You may hear a "click" sound.



5. Push the white slide-rail lock outwards as the arrow of direction below. Then pull the inner bracket out of the slide-rail assembly.



6. Release the inner bracket as shown below.



7. Align the inner bracket to the side of the chassis and make sure the screw-holes are matched. Then secure the bracket onto the chassis with provided screws.

8. Repeat Steps 2 to 7 for another slide-rail and attach its inner bracket onto another side of the chassis.

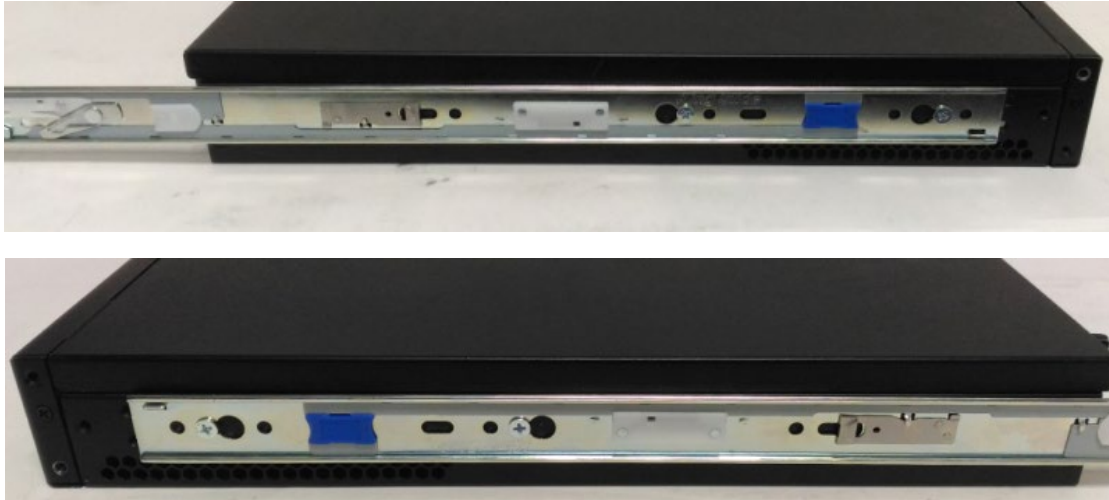

Installing Slide Rails

1. In the previous section, you have already detached the inner brackets and attached them onto the chassis of your purchased model. By now, you shall install the slide-rail assemblies onto the rack. As the image below, this slide-rail kit does NOT require screw-fixing. Simply aim at 3 available screw holes on the rack-front and lock it by clipping the slide-rail assembly to the rack-front as shown in the image below. You should hear a “click” sound once it is firmly attached.

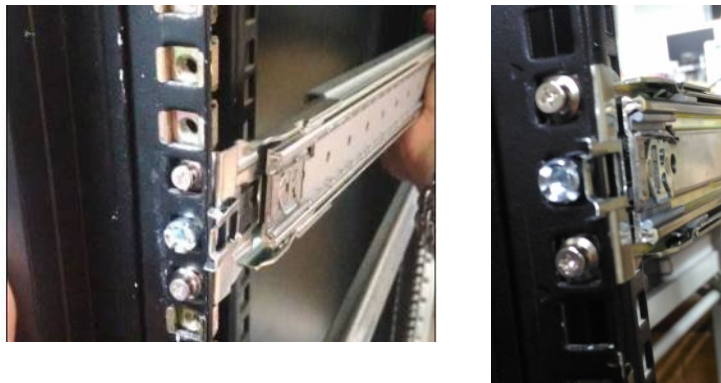

2. For the rear rack installation, also aim at 3 available holes and click the slide-rail assembly onto the rear rack.

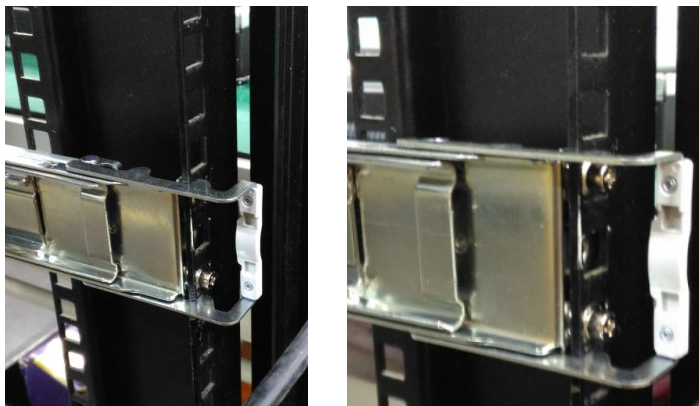

3. Repeat Step 1 and 2 for another slide-rail assembly in order to install in onto the rack.



Installing NCA-4010 onto the Rack

Reminder: it is strongly recommended to carry out this procedure with two or three persons.

1. Hold the applicable model with its front facing you, lift the chassis and gently insert the model by aligning with the slide-rail assemblies, as shown in the image below. Then push the model as far as possible.

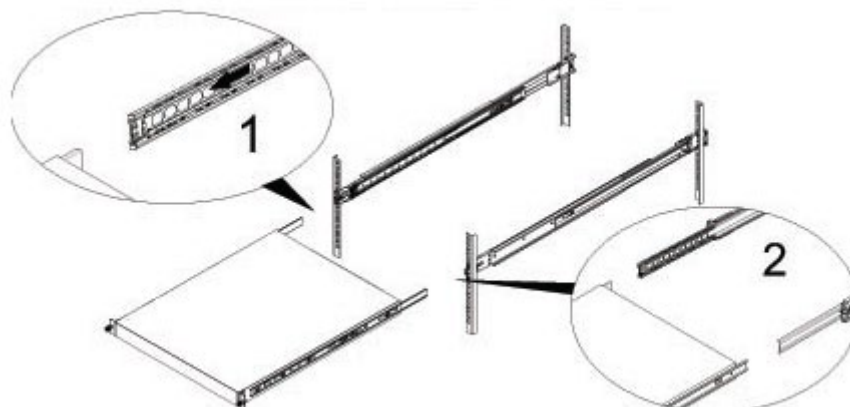

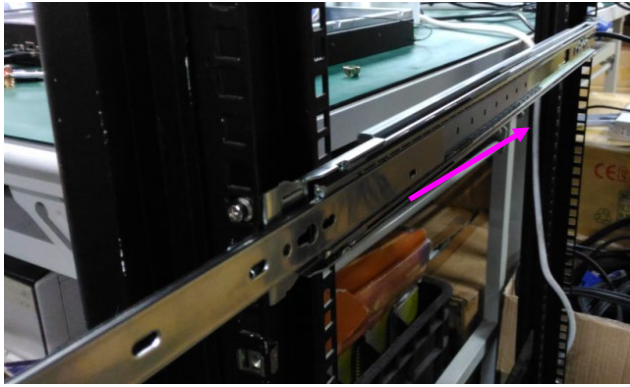

2. Simultaneously push the release tabs on both sides in the arrow of direction below, while pushing the appliance into the end of the rack.

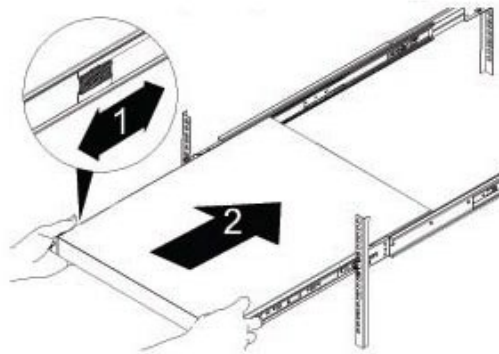

Caution: the appliance will be locked during the half way of sliding-in if the release tabs are not pushed.



3. Slide the appliance all the way into the assembly until it reaches its end.



4. To slide the appliance out, gently pull it outwards. Then, press the slide-rail locks on both side and slide the appliance out.

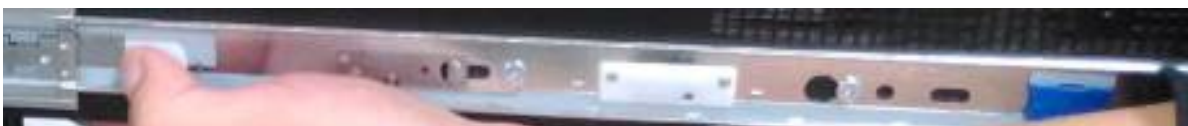

Chapter 5: BIOS Setup

To enter the BIOS setup utility, simply follow the steps below:

1. Boot up the system.
2. Press <Delete> during the boot-up. Your system should be running POST (Power-On-Self-Test) upon booting up.
3. Then you will be directed to the BIOS main screen.
4. Instructions of BIOS navigations:
 - [<--] [-->]: select a setup screen, for instance, [Main], [Advanced], [Chipset], [Boot], [Security], and [Save & Exit]
 - [↑] [↓]: select an item/option on a setup screen
 - Enter: select an item/option or enter a sub-menu
 - ESC: exit the current screen
 - +/- = to adjust values for the selected setup item/option
 - F1 = to display General Help screen
 - F2 = to retrieve previous values, such as the parameters configured the last time you had entered BIOS.
 - F3 = to load optimized default values
 - F4 = to save configurations and exit BIOS

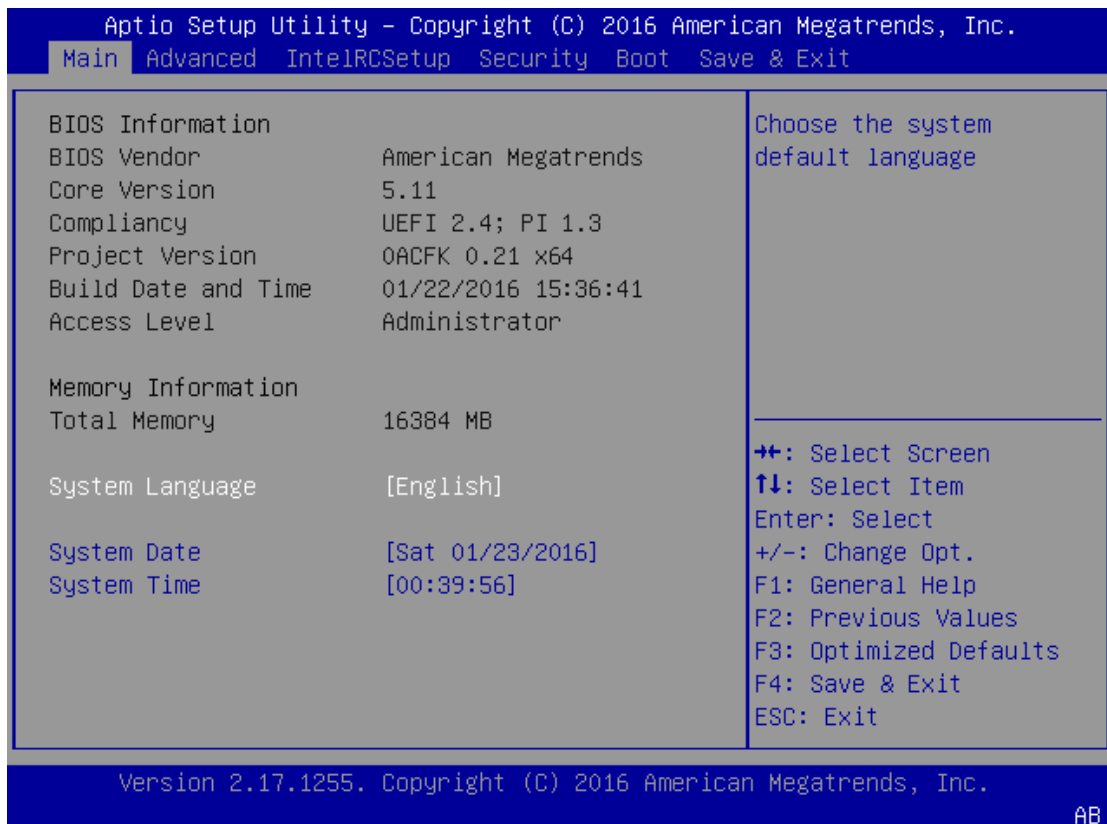

Notes: the images in the following section are for reference only.

Main

The [Main] is the first setup screen when you enter BIOS. The [Main] displays general system and BIOS information and you may configure the “System Language”, “System Date”, and “System Time”.

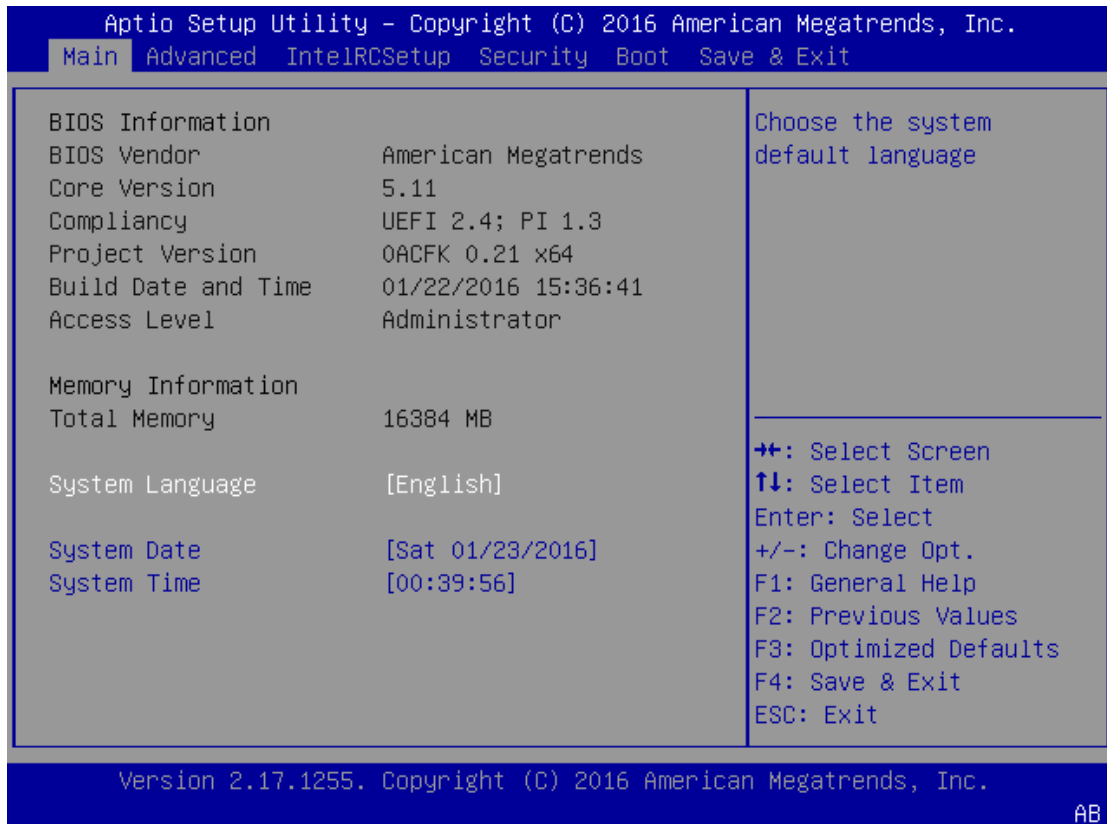

BIOS Information

BIOS Vendor: displays BIOS vendor information

Core Version: displays the BIOS core version

Compliance: displays the BIOS compliance

Project Version: displays BIOS project version

Build Date and Time: displays the date and time the BIOS was built.

Press “Enter” if you want to configure “System Language”, “System Date”, and “System Time”.

System Language: English

System Date: Day/Month/Year

System time: Hour/Minutes/Seconds

Advanced

Use [←] / [→] to select [Advanced] setup screen. Under this screen, you may use [↑] [↓] to select an item you wish to configure.

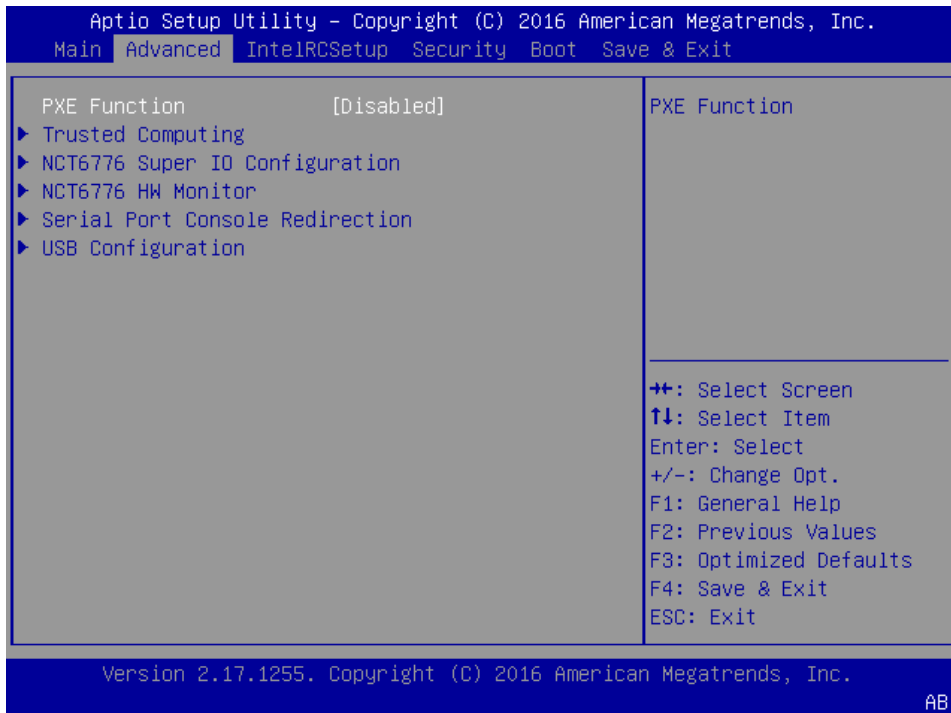

PXE Function

This option allows users to set PXE (Preboot Execution Environment) functions. Users may enable LAN2 to LANX depending on their applications.

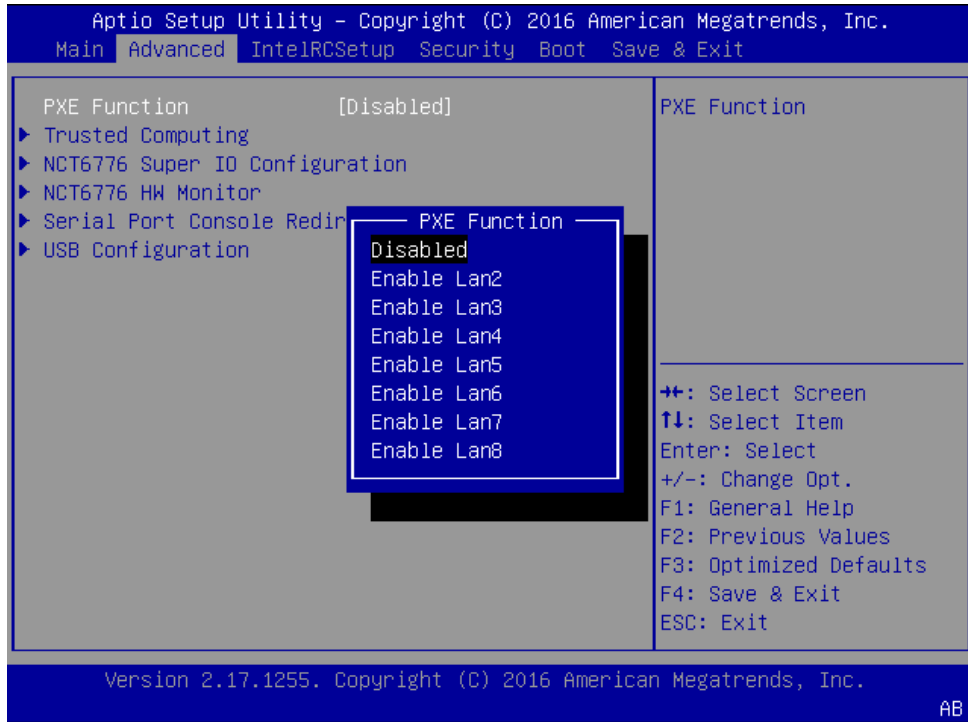

Trusted Computing

This option enables users to configure “Trusted Computing” settings. Please be noted that TPM module shall have been installed first in order to make any configuration.

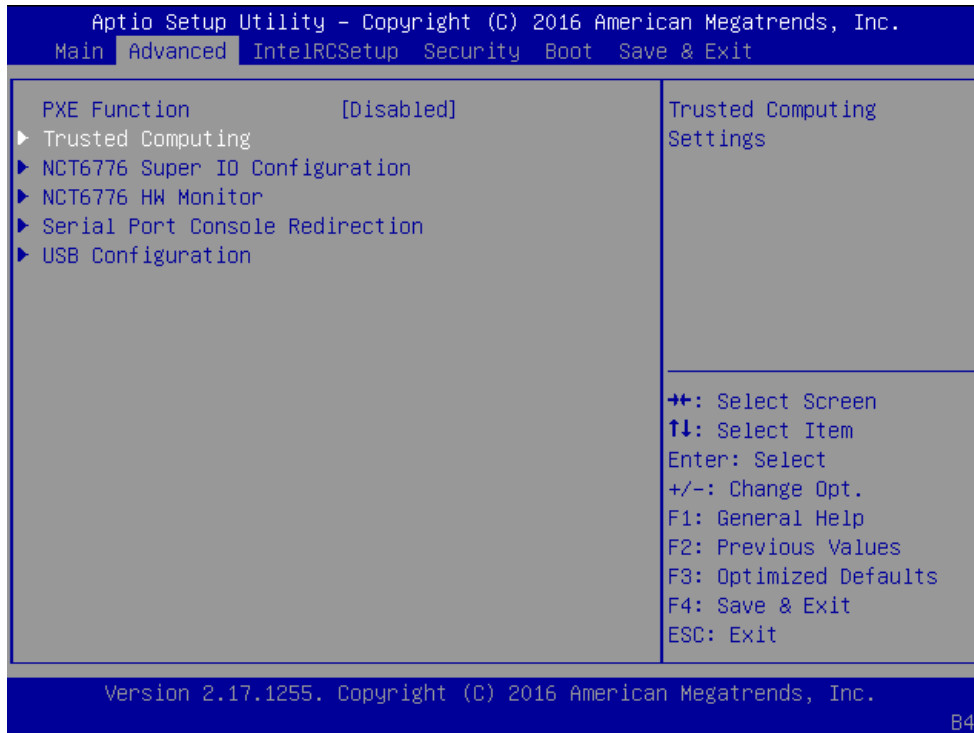

Security Device Support: this enables or disables BIOS support for security device. Please be noted that the operating system will not show Security Device. Also, TCG EFI protocol and INT1A interface will not be available.

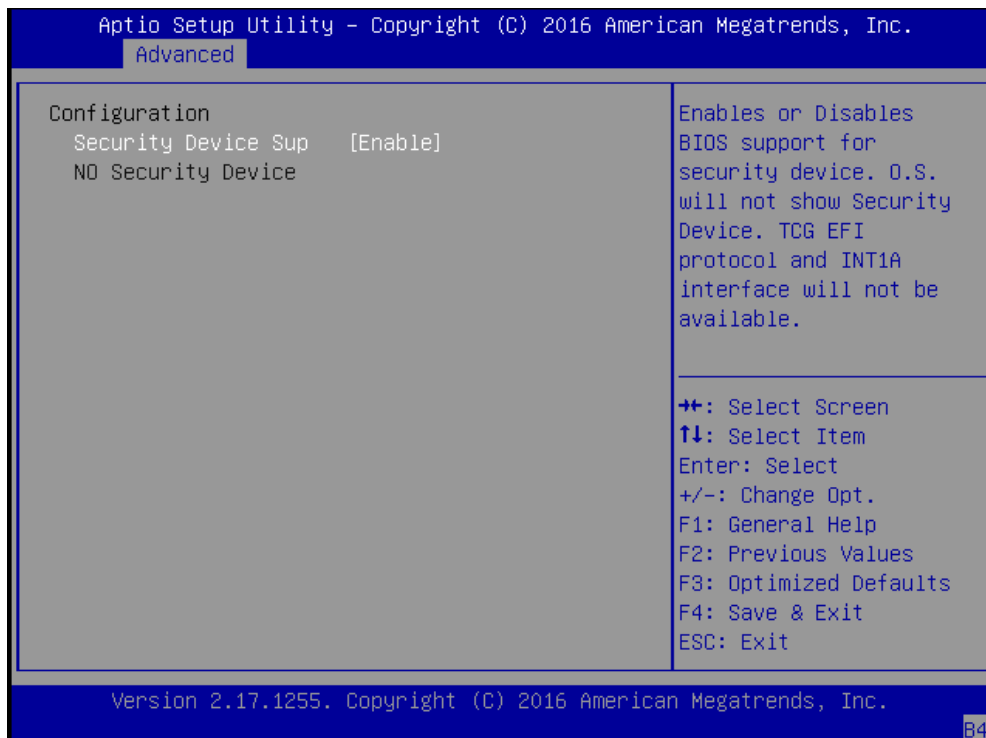

NCT6776 Super IO Configuration

Press "Enter" to access configuration sub-menu for super IO chip (NCT6776) parameters. You may access settings for Serial Port 1 or 2 or the Parallel port.

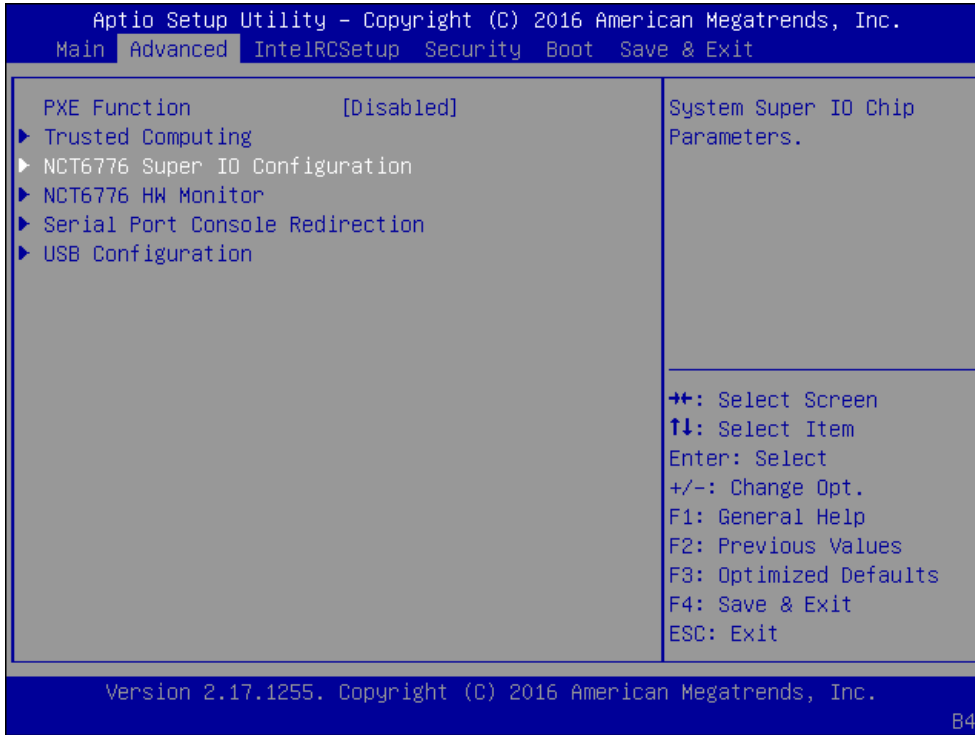

NCT6776 Super IO Configuration - Serial Port 1 Configuration

The super IO chip for this model is NCT6776. You may enable or disable Serial Port 1(COMA).

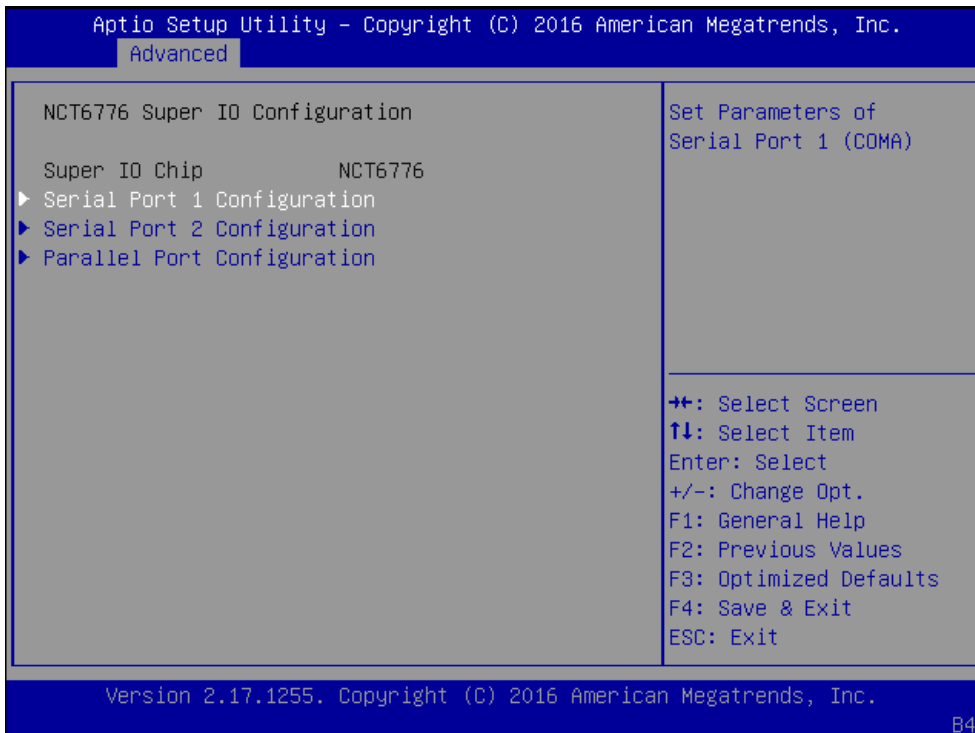

Press "Enter" to enable or disable the Serial Port 1 (COMA). Device setting is fixed as default.

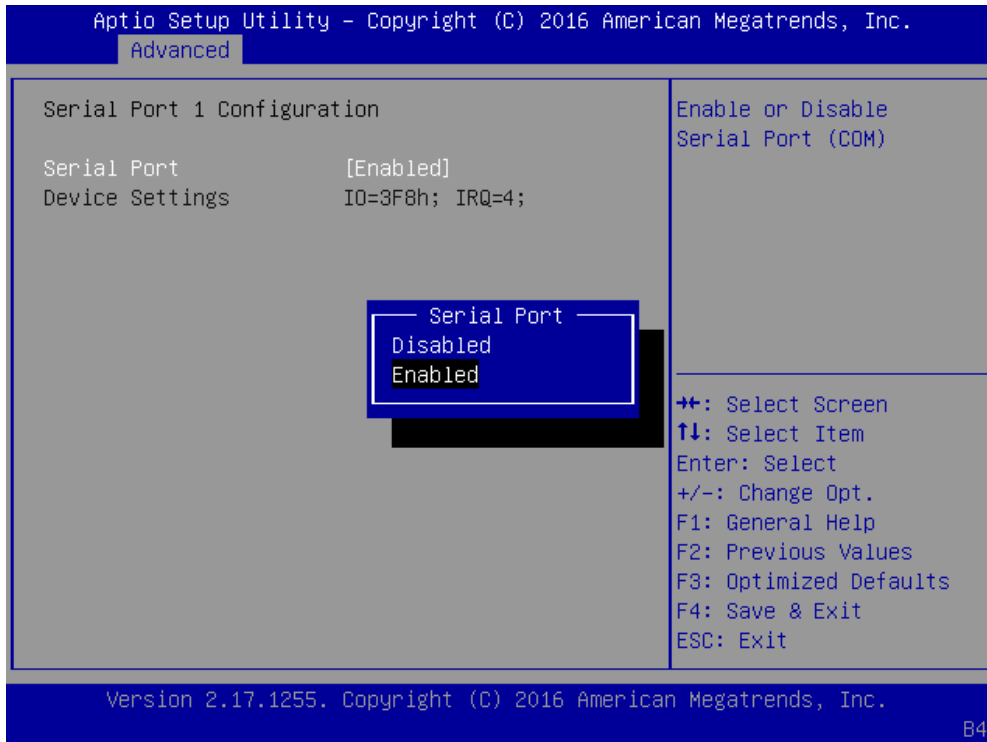

NCT6776 Super IO Configuration - Serial Port 2 Configuration

Once Serial Port 2 is accessed, you may press "Enter" to enable or disable the Serial Port 2 (COM). Device setting is fixed as default.

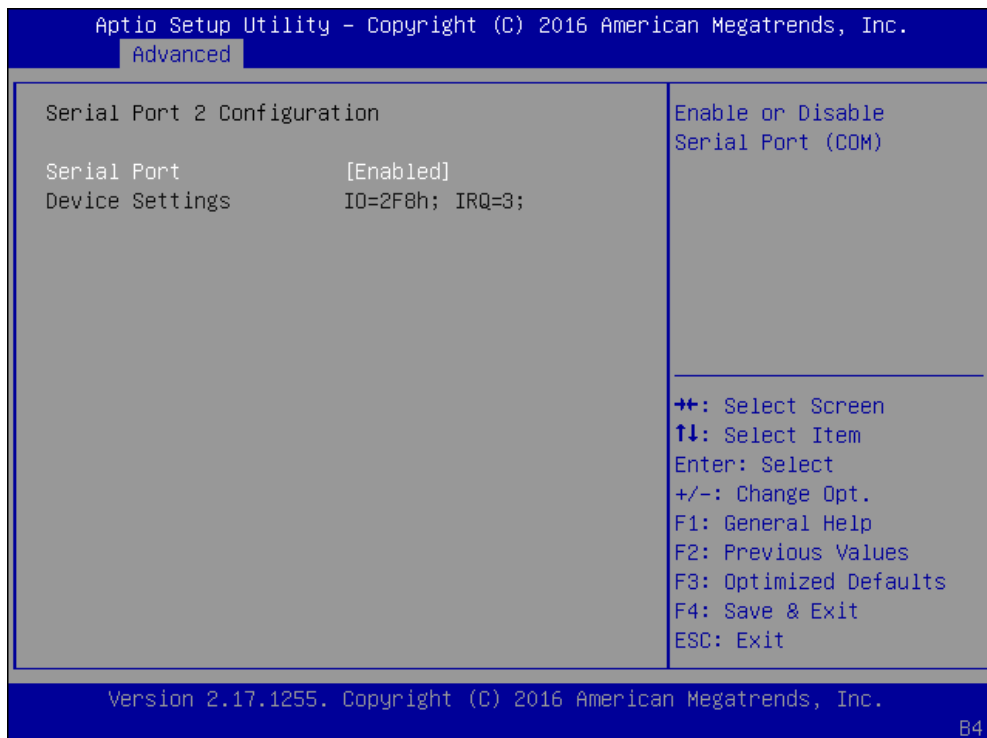

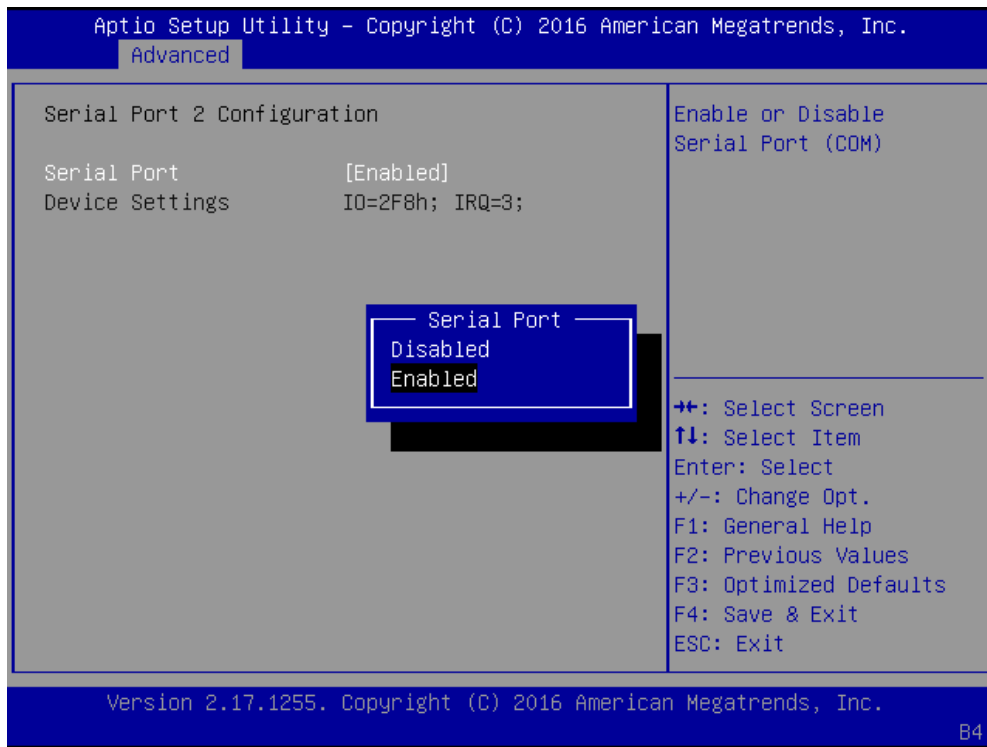

Parallel Port Configuration

This option allows you to set parameters for parallel port (LPT/LPTE).

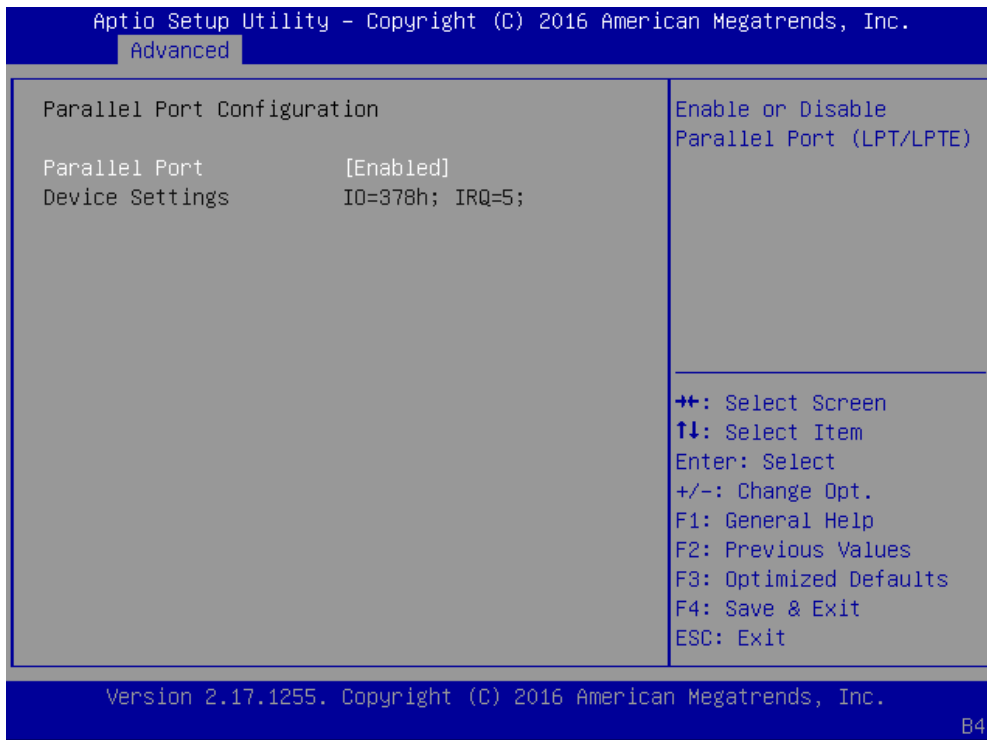

Once Parallel Port is accessed, you may press “Enter” to enable or disable the Parallel Port. Device setting is fixed as default.

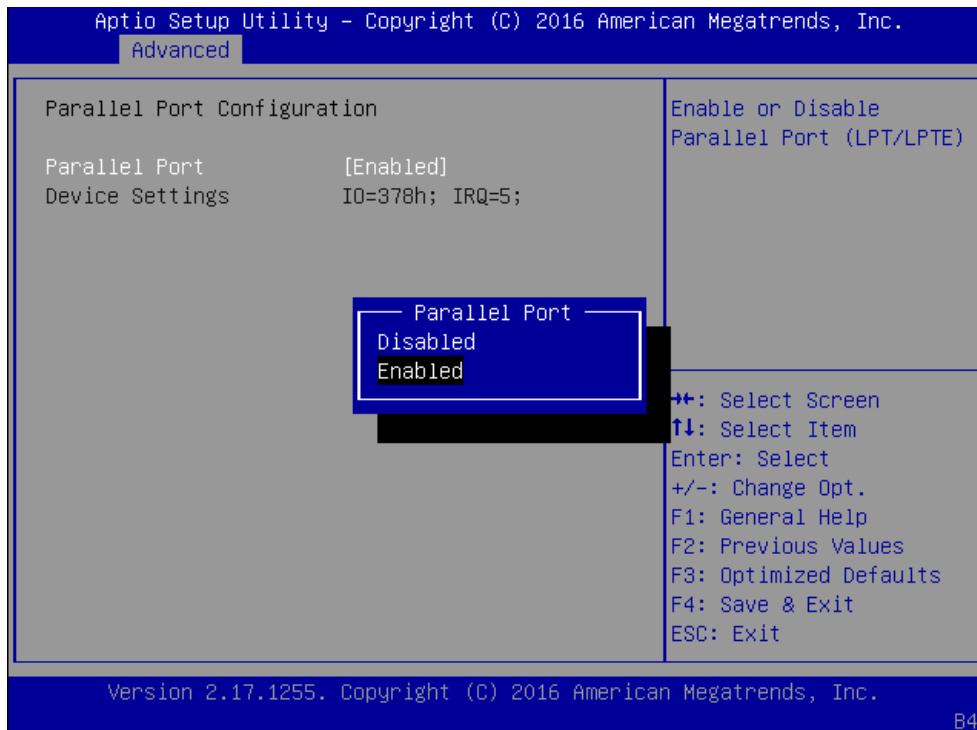

NCT76776 HW Monitor

This option allows you to view hardware health status.

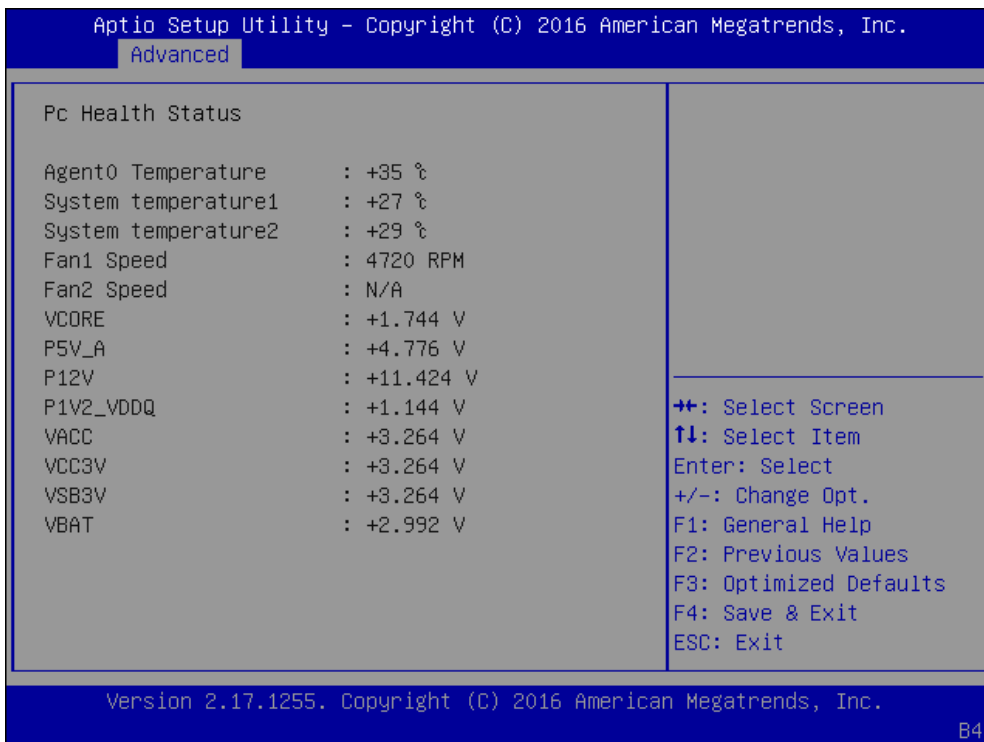
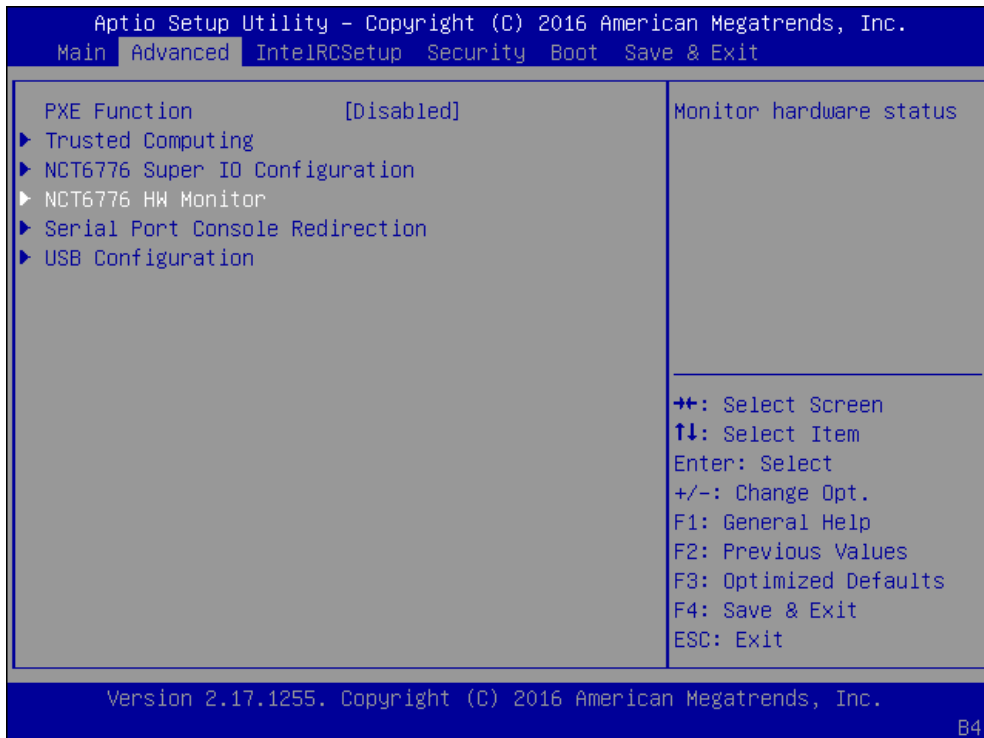

Serial Port Console Redirection

This option allows you to configure parameters about serial port console redirection. Press “Enter” to access the submenu.

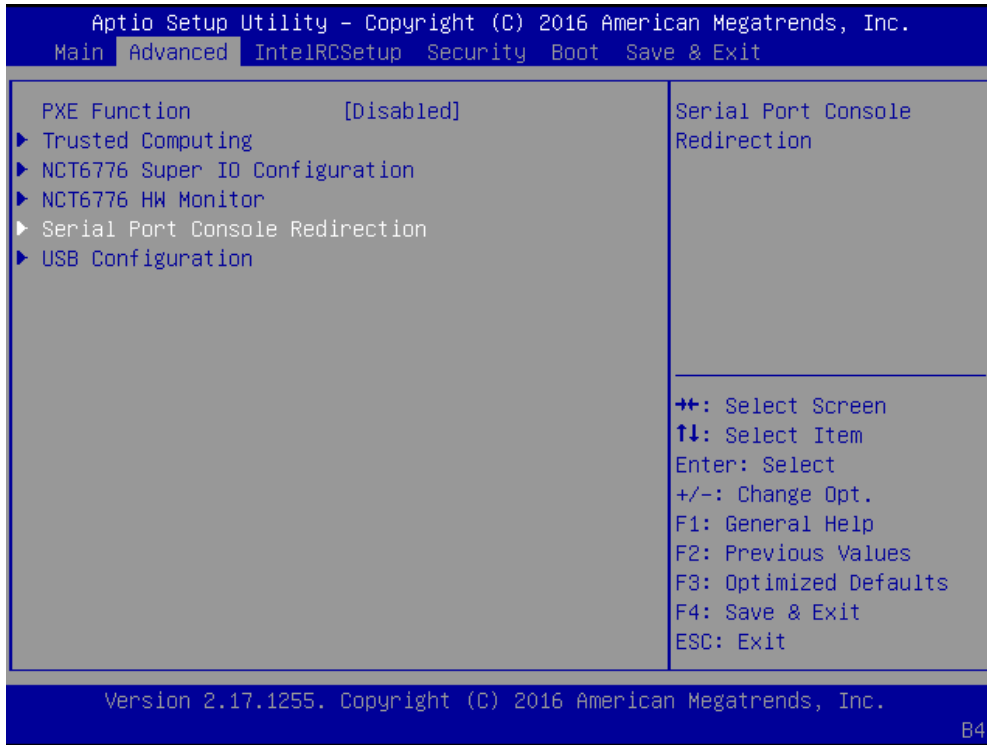

Console Redirection: select “Enabled” or “Disable” for COM port console redirection. The default is “Enabled”.

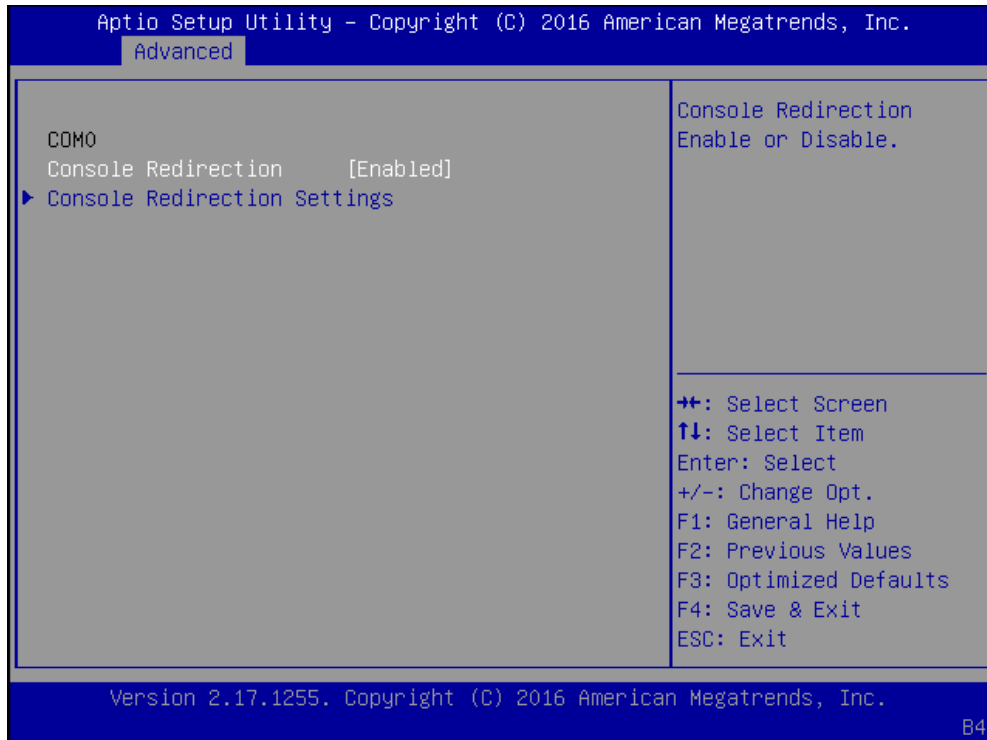

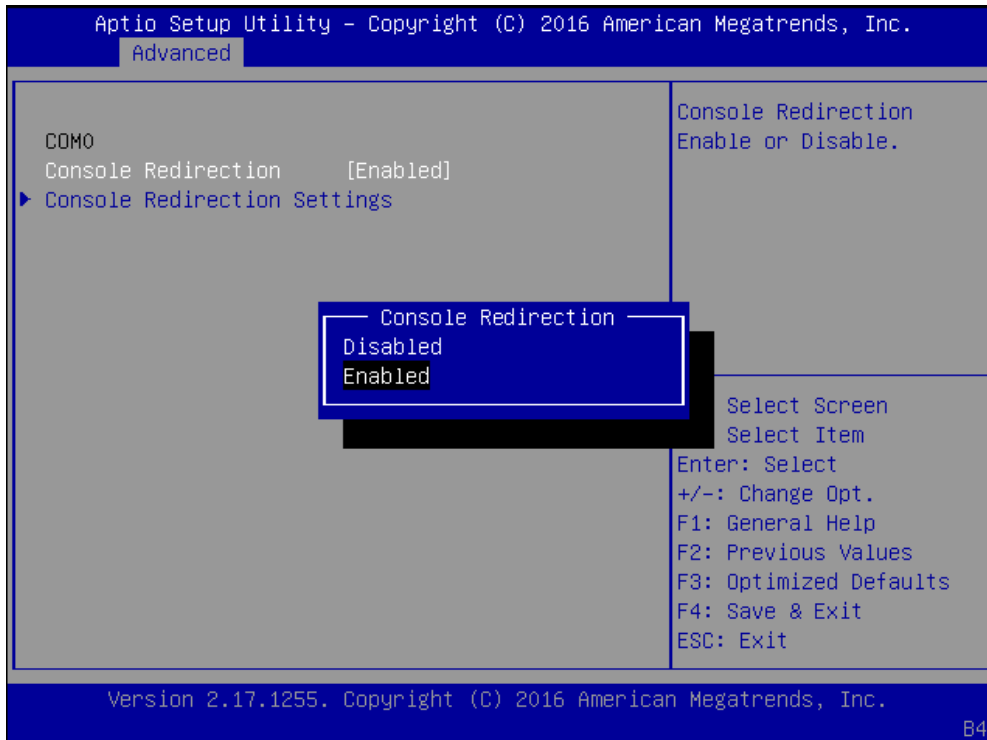

Console Redirection Settings: select this item to enter the setting sub-menu.

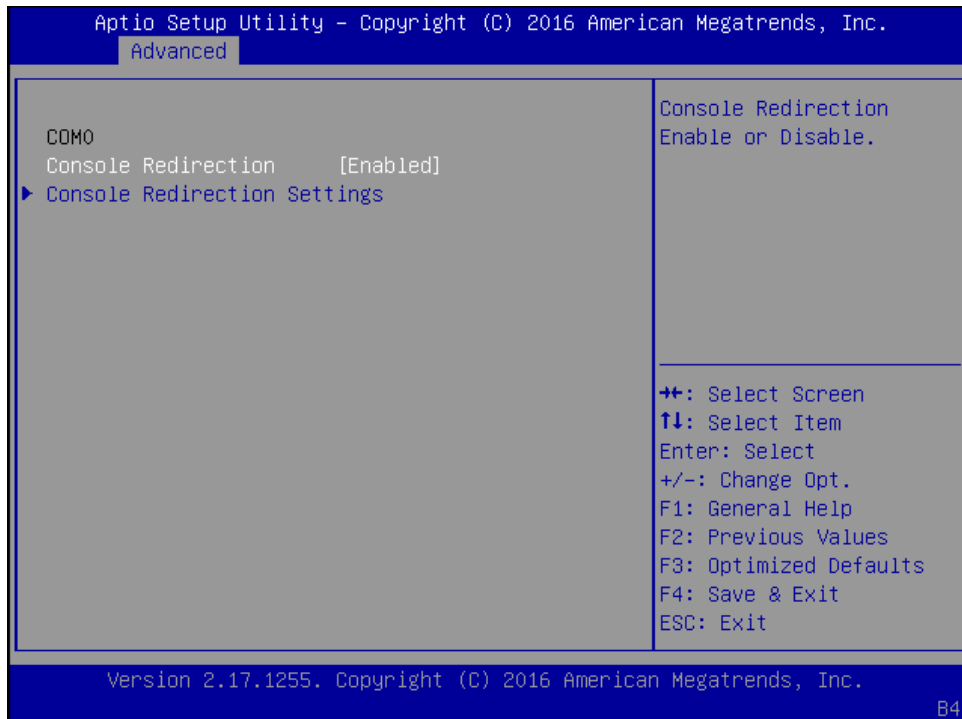

COM Console Redirection Settings

Terminal Type: the emulation configuration. Select "VT100", "VT100+", "VT-UTF8" or "ANSI".

VT100: ASCII character set

VT100+: extends VT100 to support color function keys

VT-UTF8: uses UTF8 encoding to map Unicode characters onto 1 or more

ANSI: Extended ASCII character set

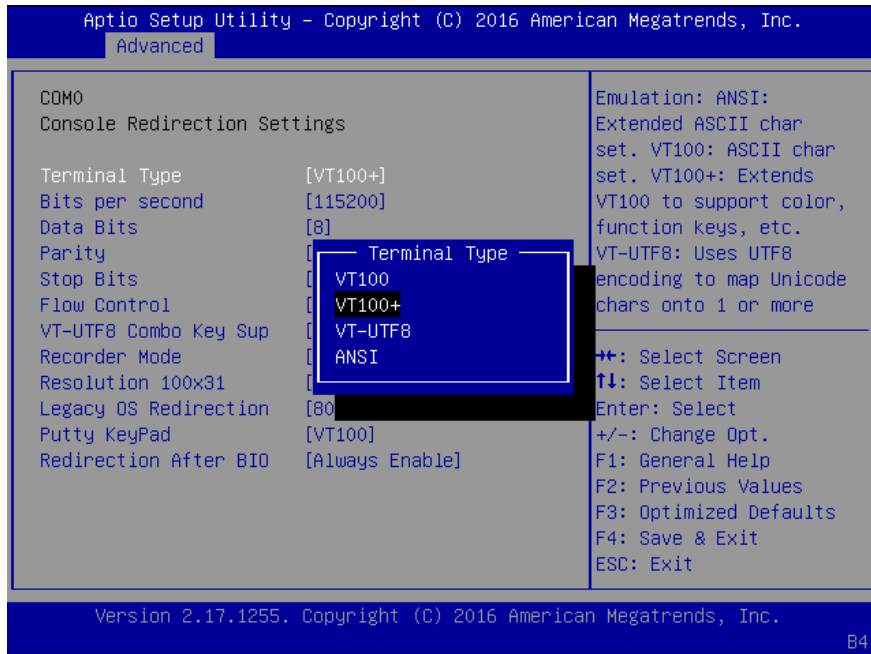

Bits per second: select "9600", "19200", "38400", "57600", or "115200" for bits per second. The Bps will determine serial port transmission speed. The speed must be matched on the other side. Long or noisy lines may require lower speeds

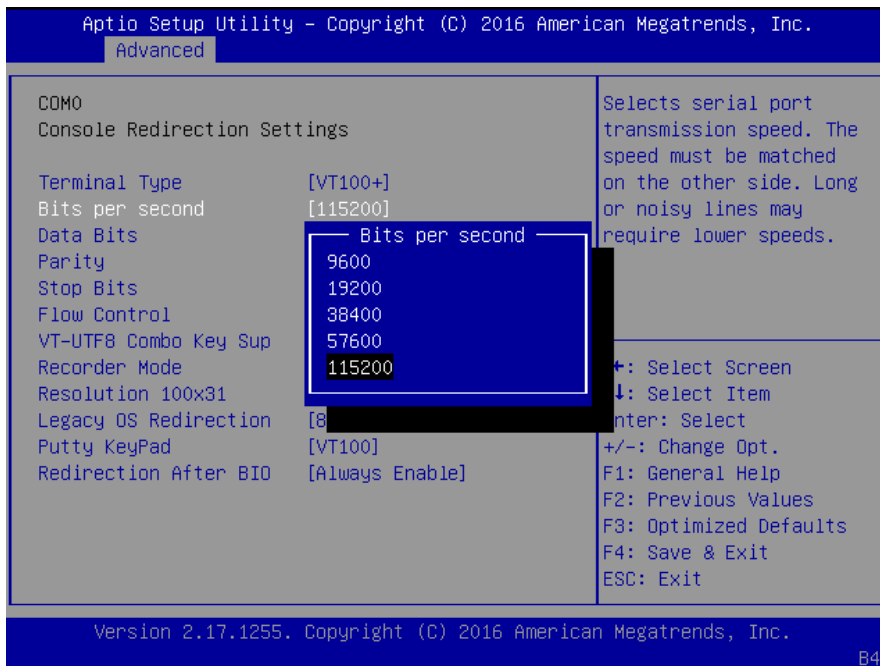

Data Bits: select the value for data bits. In this case, "7" or "8".

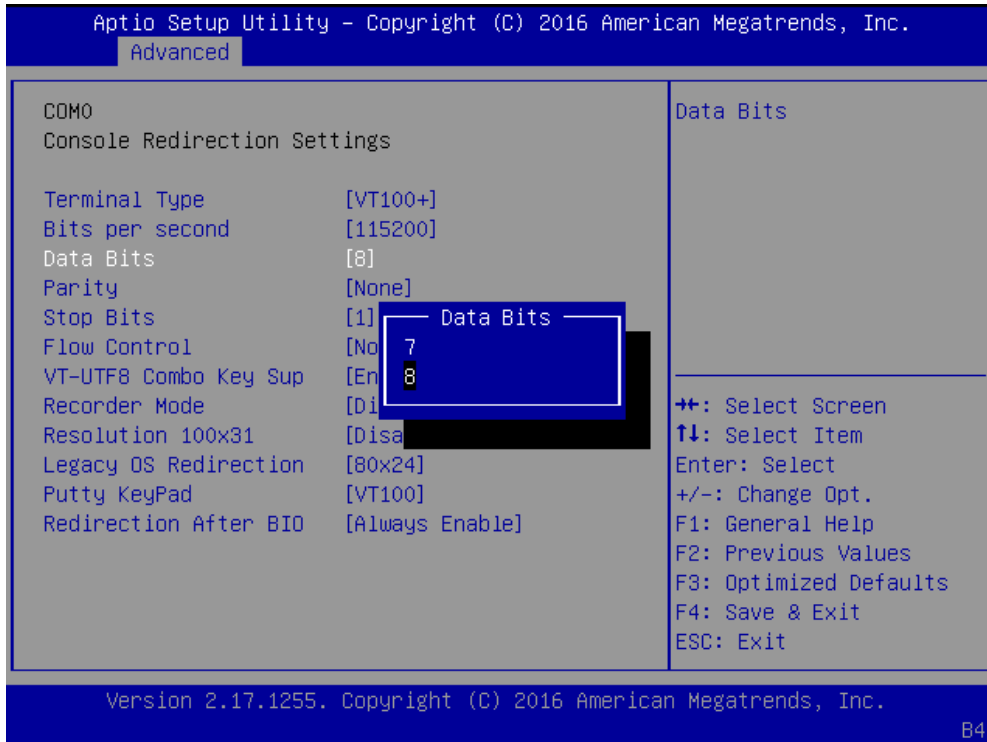

Parity Bits: a parity bit can be sent with the data bits to detect some transmission errors. Select "None", "Even", "Odd", "Mark" or "Space".

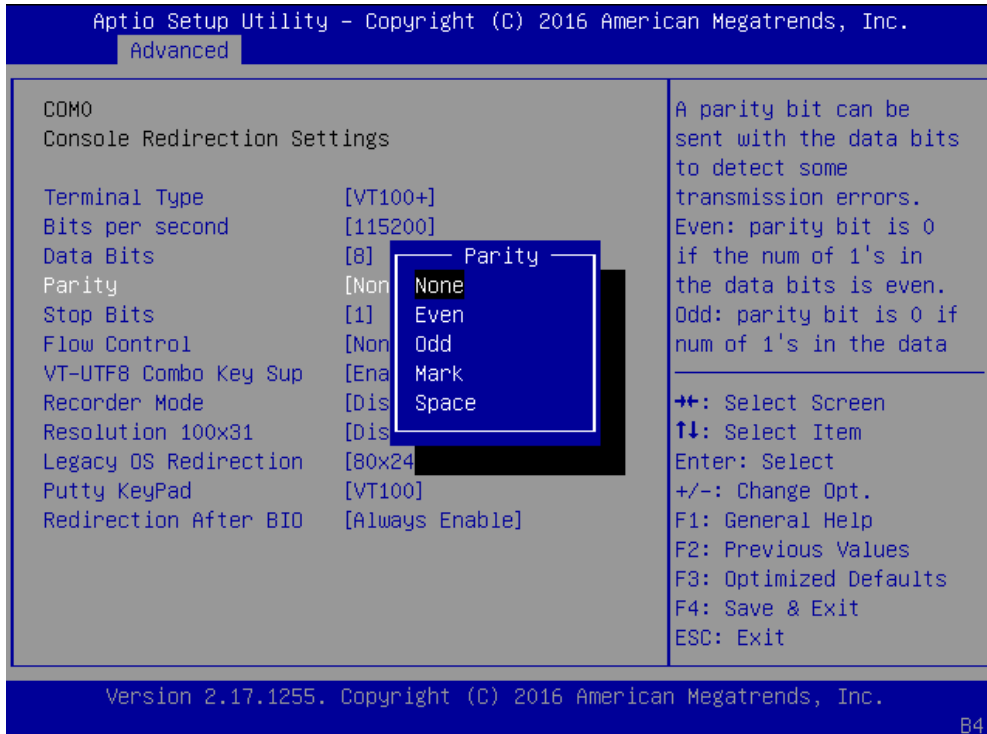

Stop Bits: stop bits indicate the end of a serial data packet. The standard is 1 stop bit. Communication with slow devices may require more than 1.

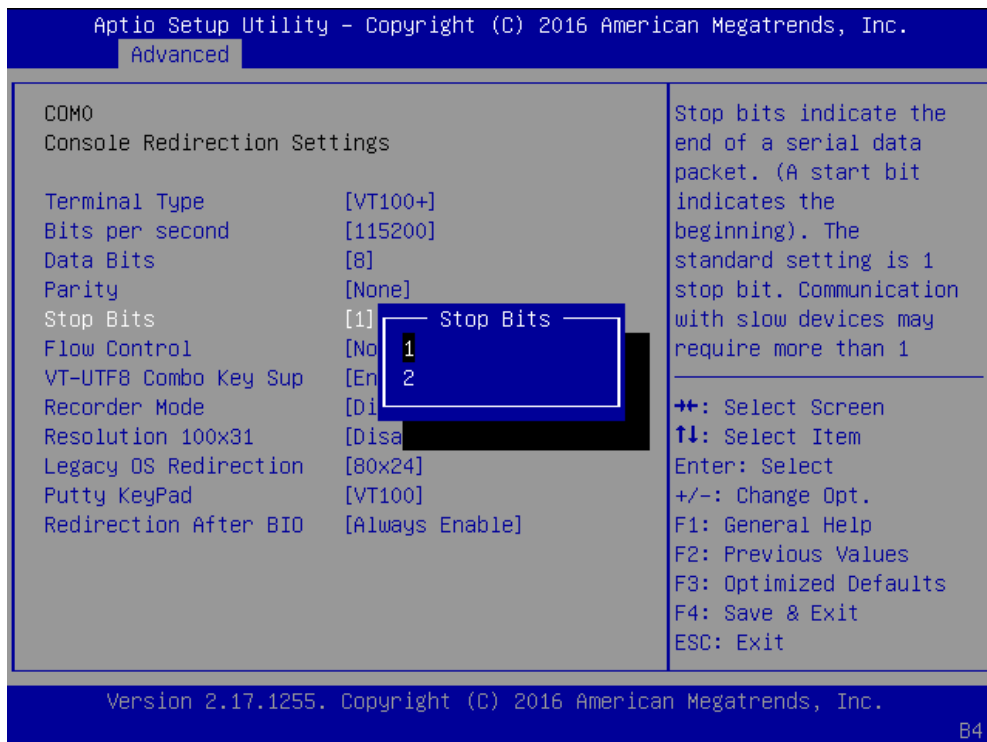

Flow Control: flow control can prevent data loss from buffer overflow. When sending data, if the receiving buffers are full, a “stop” signal can be sent to stop the data flow. You may select “None” or “Hardware RTS/CTS”, depending on the circumstances.

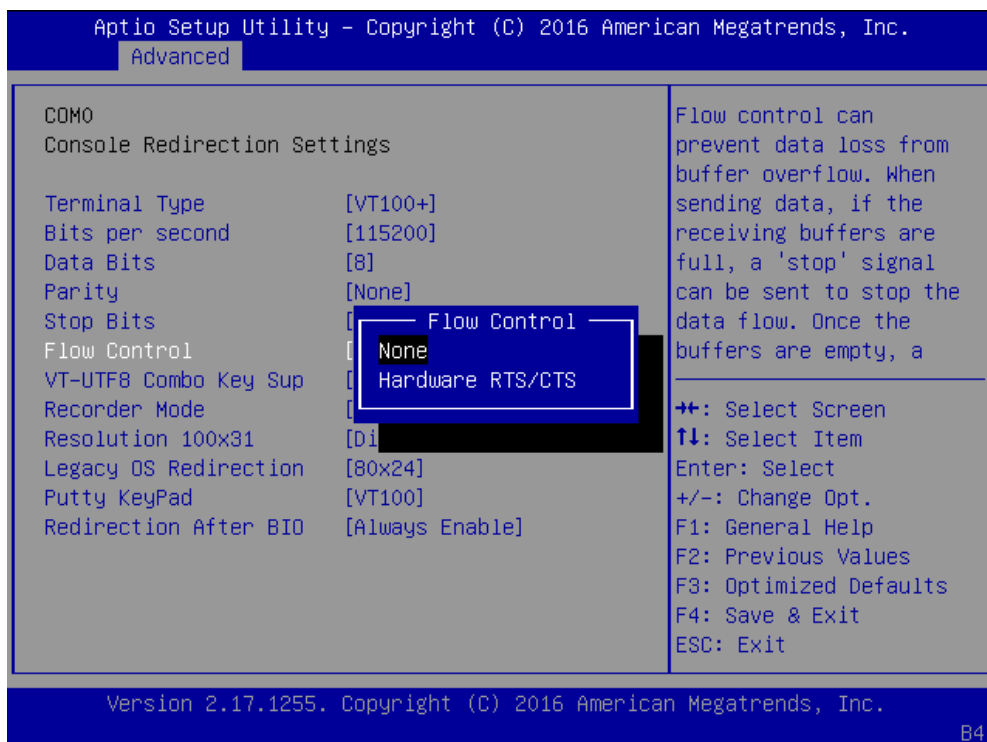

VT-UTF8 Combo Key Support: this option enables/disables VT-UTF8 combination key support for ANSI/VT100 terminals.

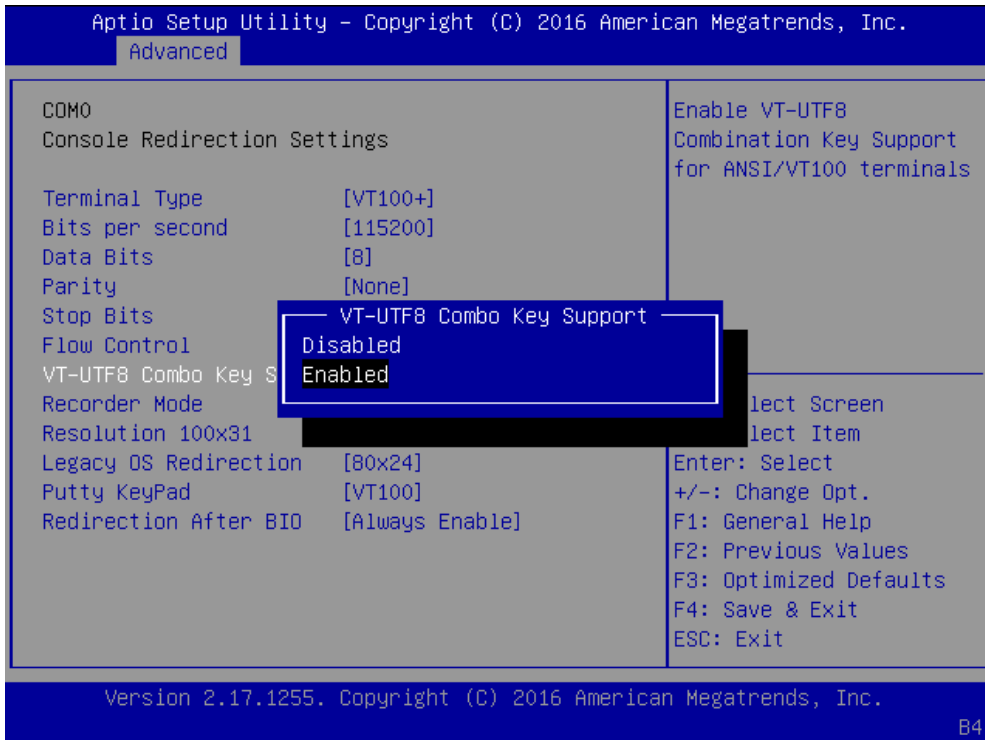

Recorder Mode: on this mode, when "Enabled", only text will be sent. This is to capture terminal data.

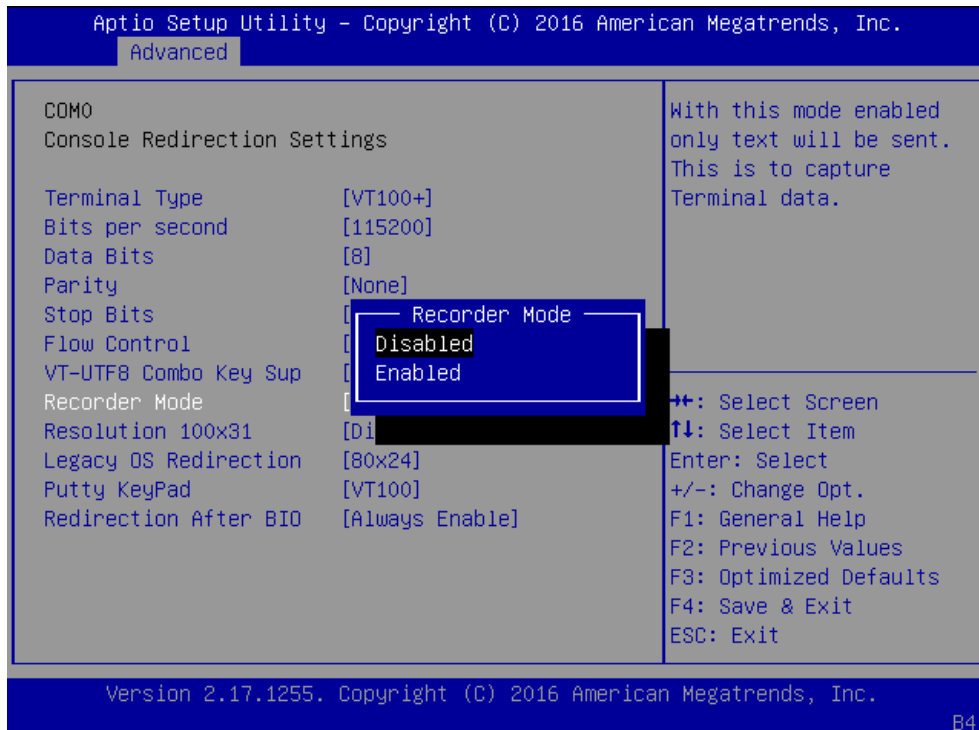

Resolution 100 x 31: select "Enable" or "Disable" for extended terminal resolution.

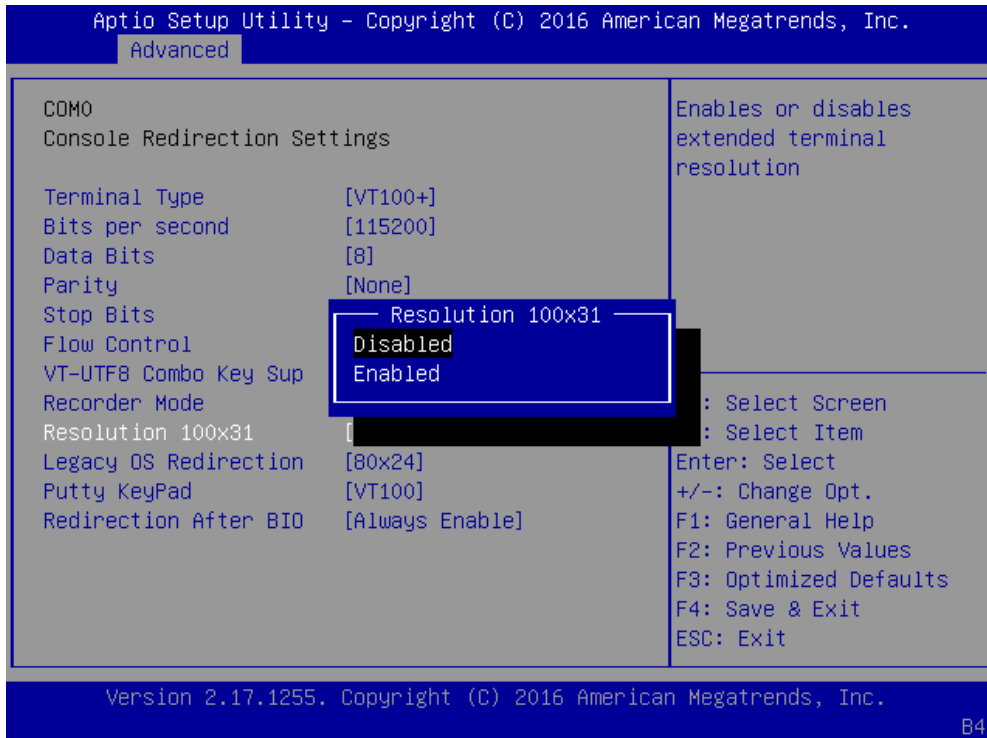

Legacy OS Redirection Resolution: select "80x24" or "80x25". The default for this case is "80x24".

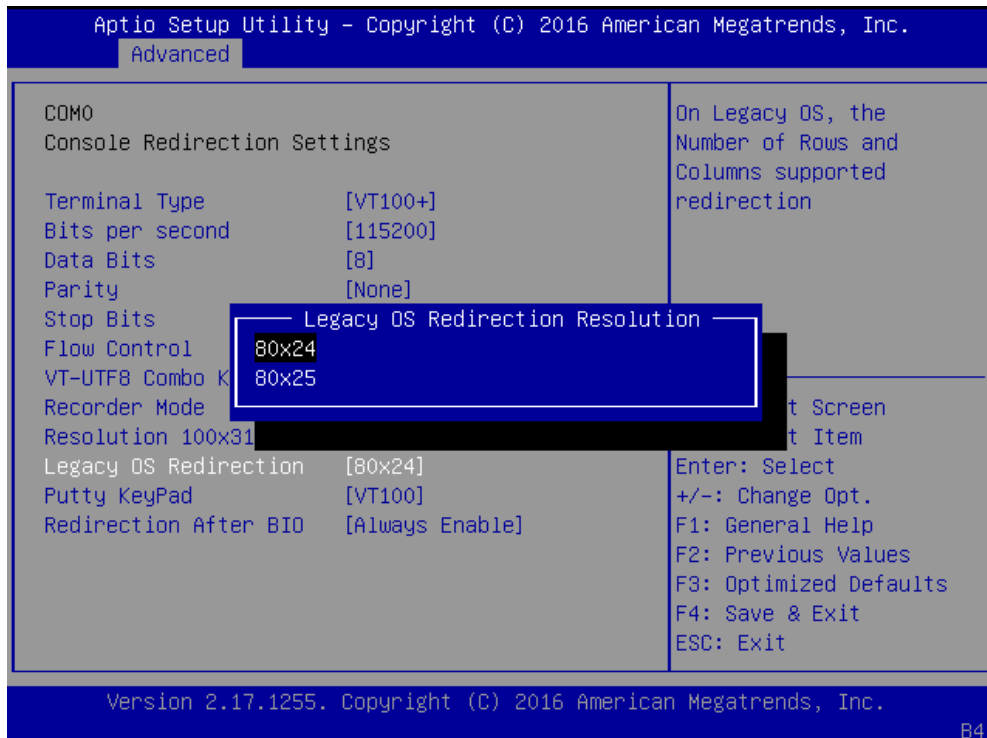

Putty KeyPad: select Function Key and Key Pad on Putty. You may select "VT100", "LINUX", "XTERMR6", "SCO", "ESCN", or "VT400".

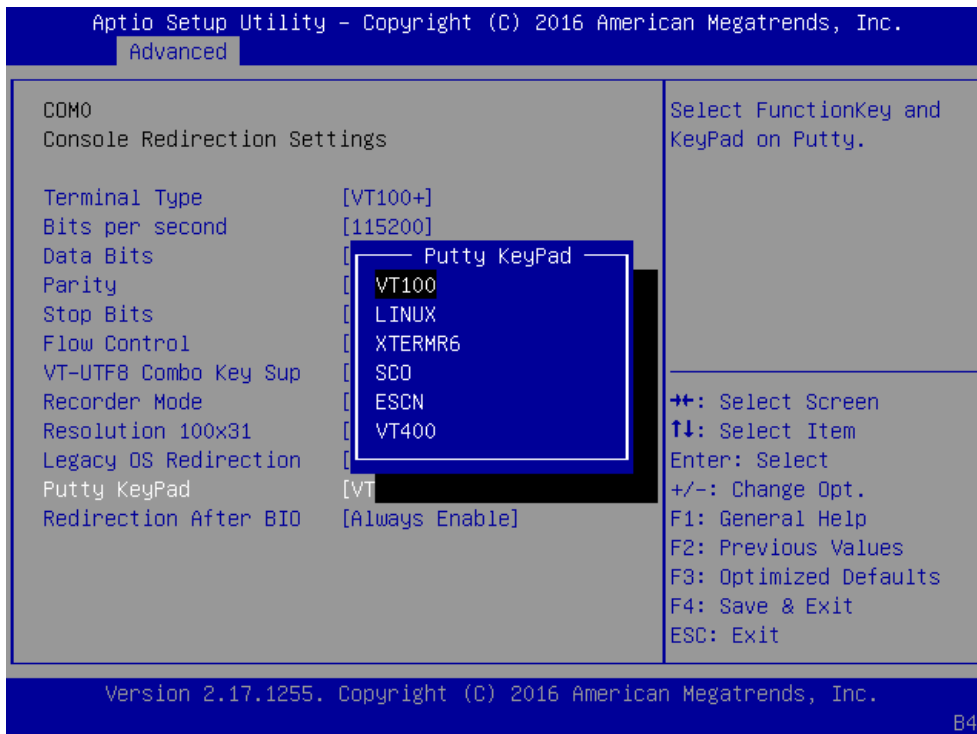

Redirection After BIOS POST: The settings specify if BootLoader is selected than Legacy console redirection is disabled before booting to Legacy OS. Default value is "Always Enable" which means Legacy OS console redirection is always enabled after BIOS.

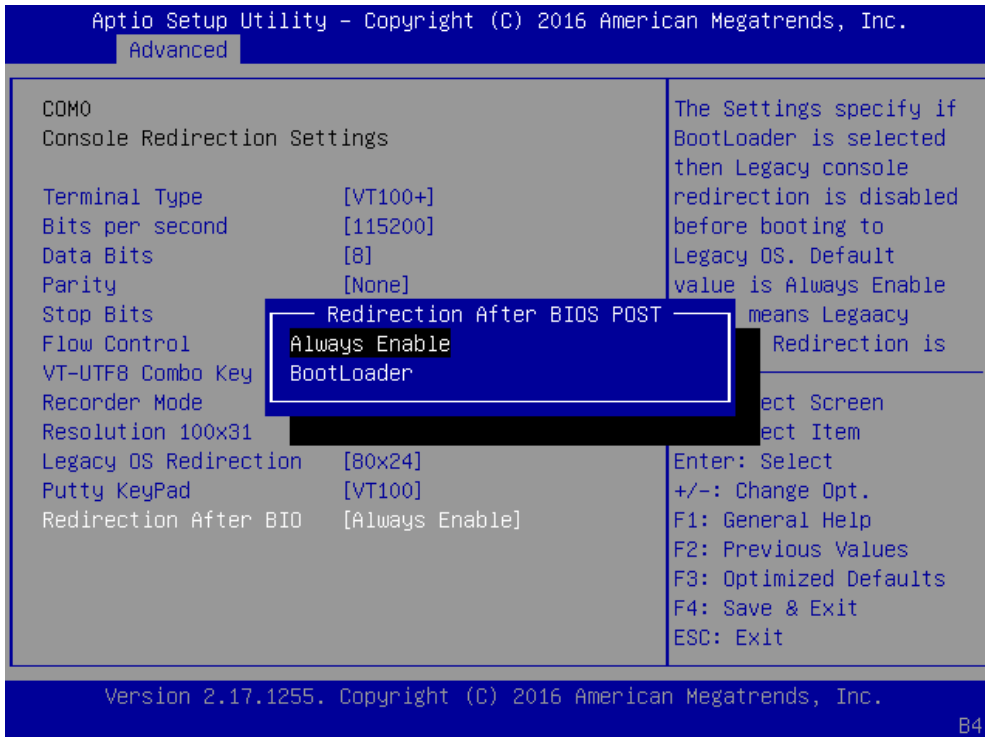

USB Configuration

This option allows you to configure USB device Settings.

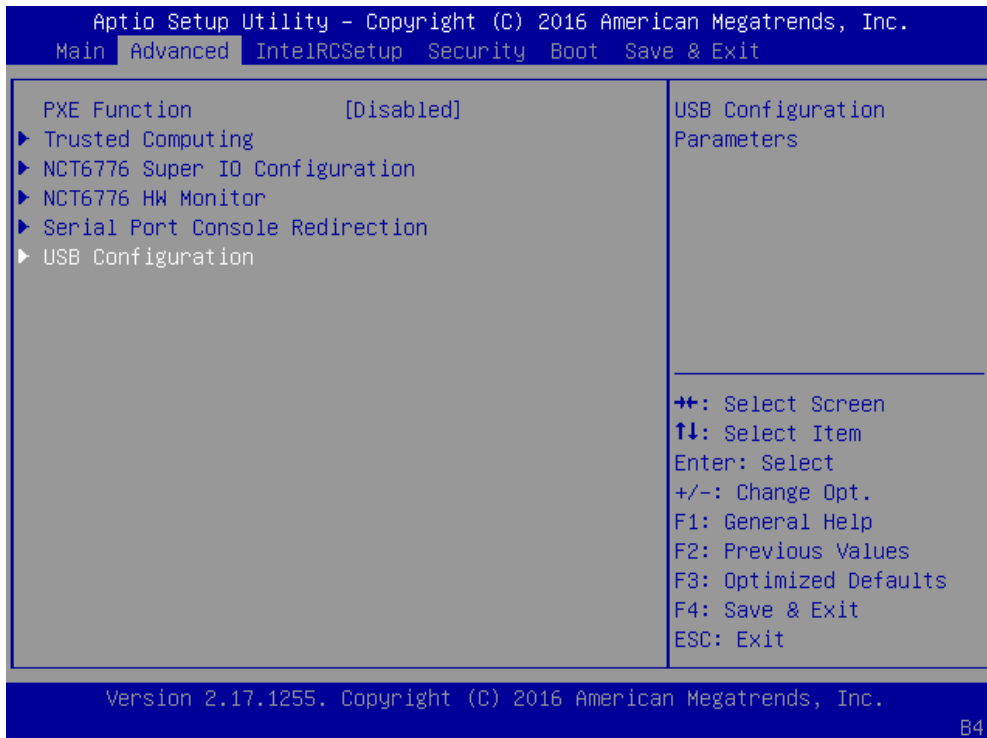

USB Module Version: displays USB module version

USB Devices: displays USB devices

USB Controllers: displays USB controller information

Legacy USB Support: this function enables or disables legacy USB support. Auto option disables legacy support if no USB devices are connected. Disable option will keep USB devices available only for EFI applications.

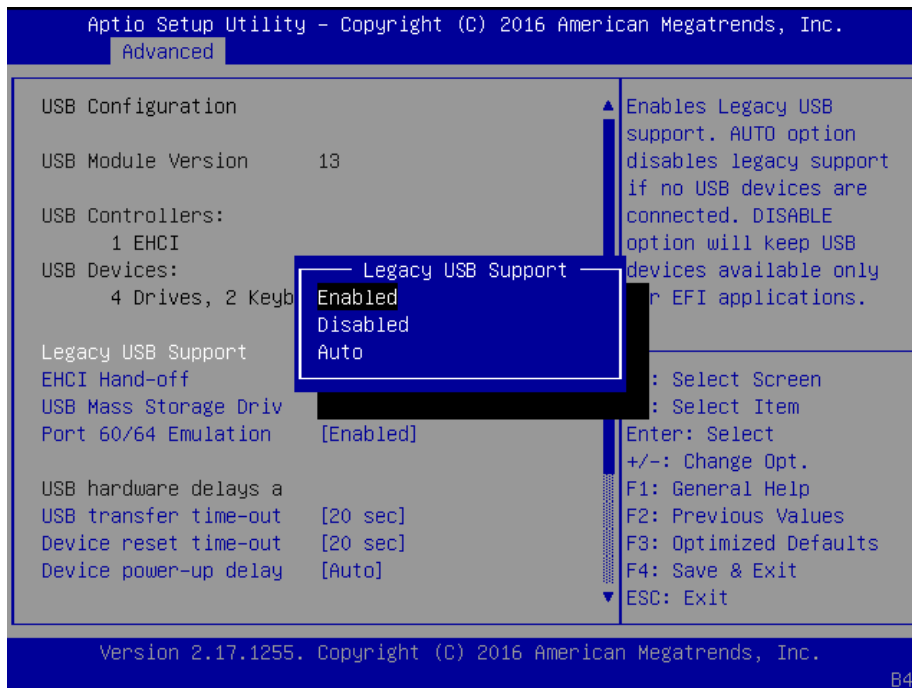

EHCI Hand-off: enables or disables EHCI Hand-off function. This is a workaround for operating systems without EHCI hand-off support. The EHCI ownership change should be claimed by EHCI driver.

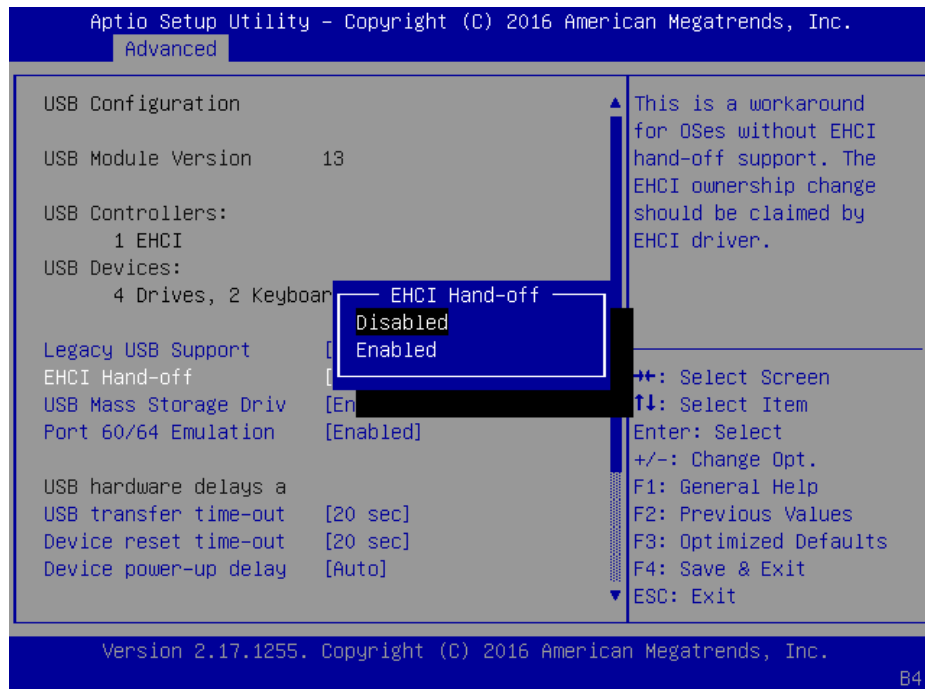

USB Mass Storage Driver: this option allows you to enable or disable USB mass storage driver. The default is "Enabled".

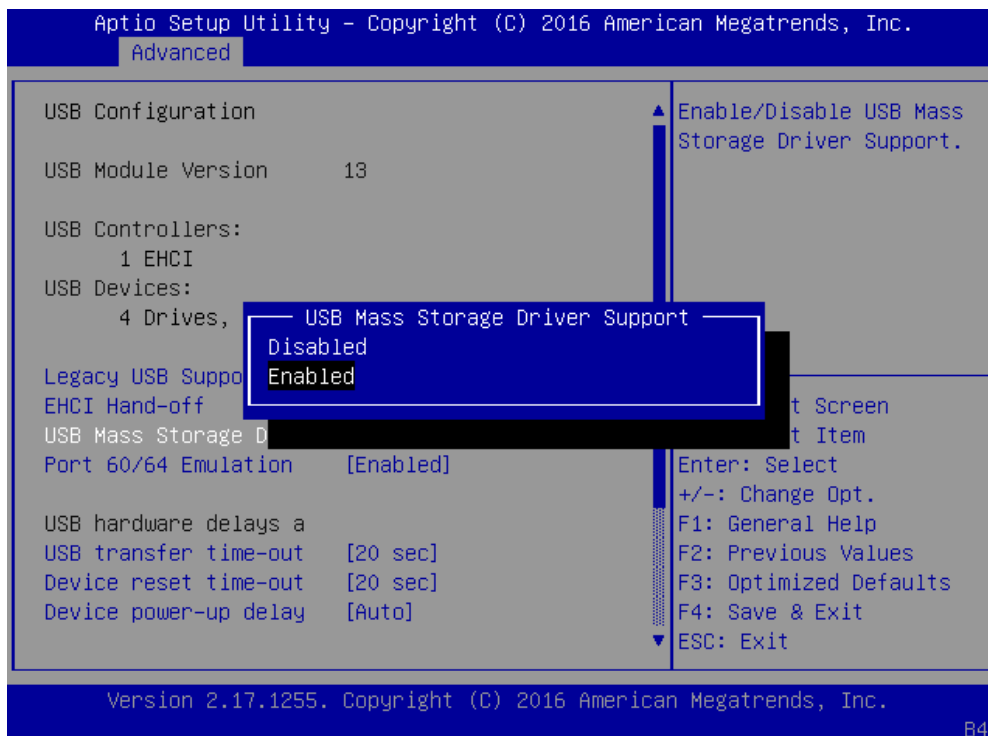

Port 60/64 Emulation: this option enables I/O port 60h/64h emulation support. This should be enabled for the complete USB keyboard legacy support for non-USB aware operating systems.

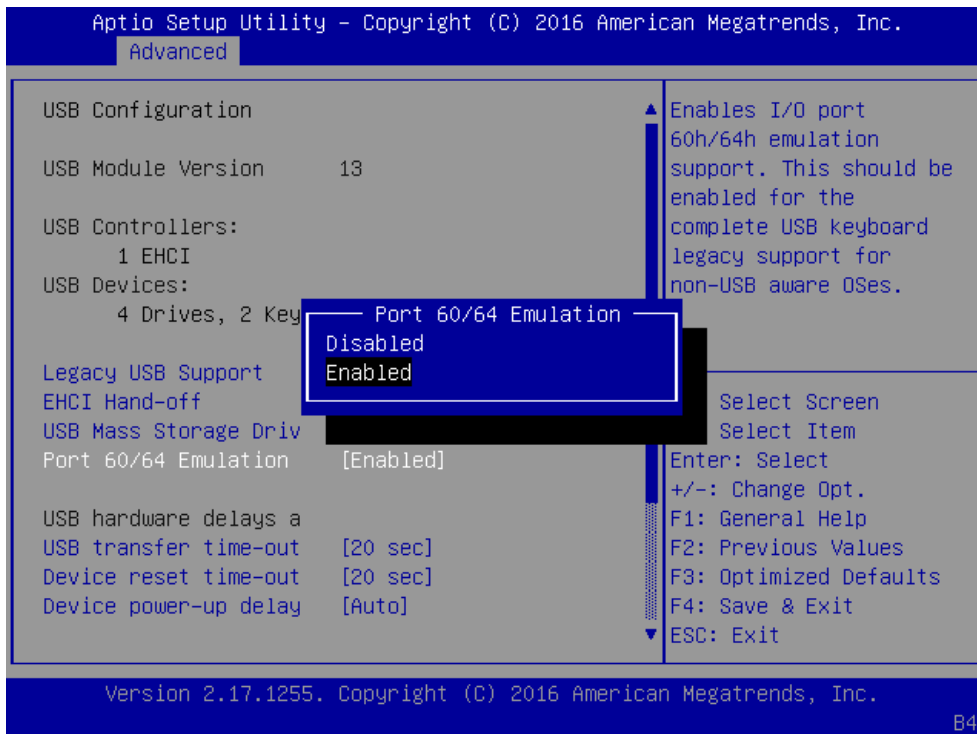

USB transfer time-out: set USB time-out value (1, 5, 10 or 20 seconds) for Control, Bulk and Interrupt transfers.

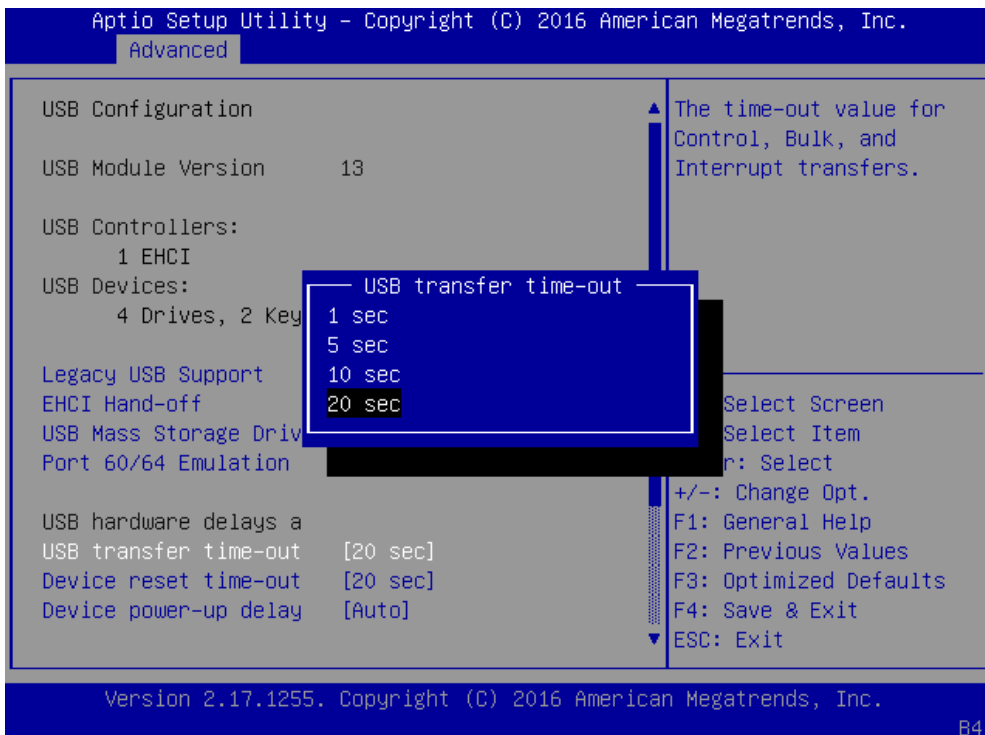

Device reset time-out: set USB mass storage device Start Unit command time-out (10, 20, 30 or 40 seconds).

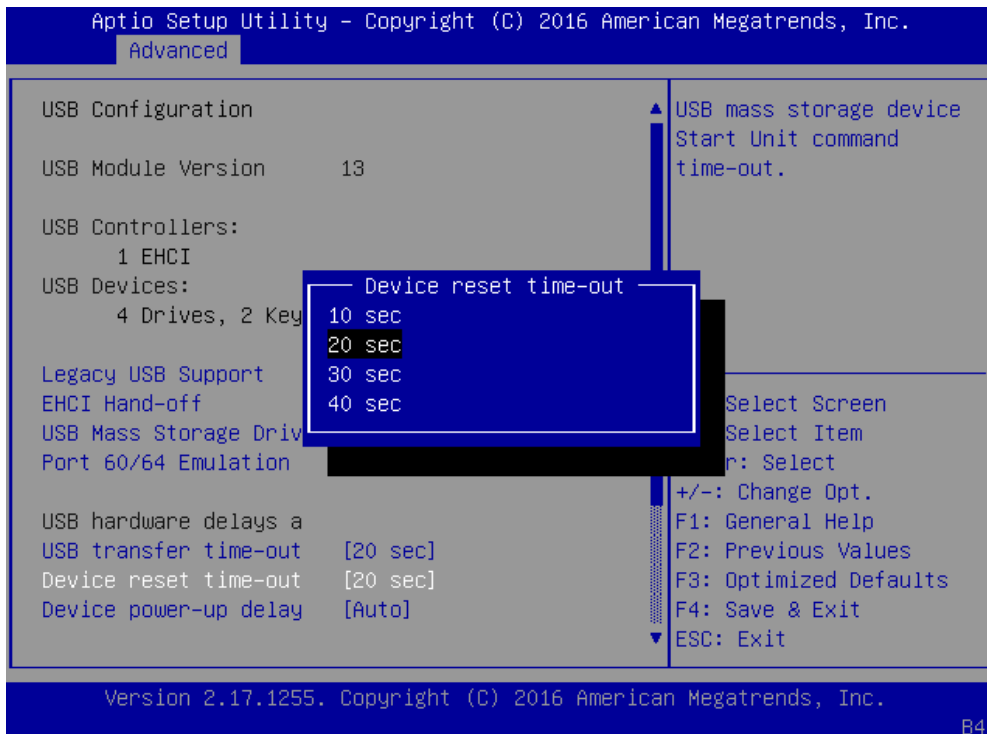

Device power-up delay: set the maximum time the device will take before it properly reports itself to the Host Controller. "Auto" uses default value. For example, it is 100ms as a root port.

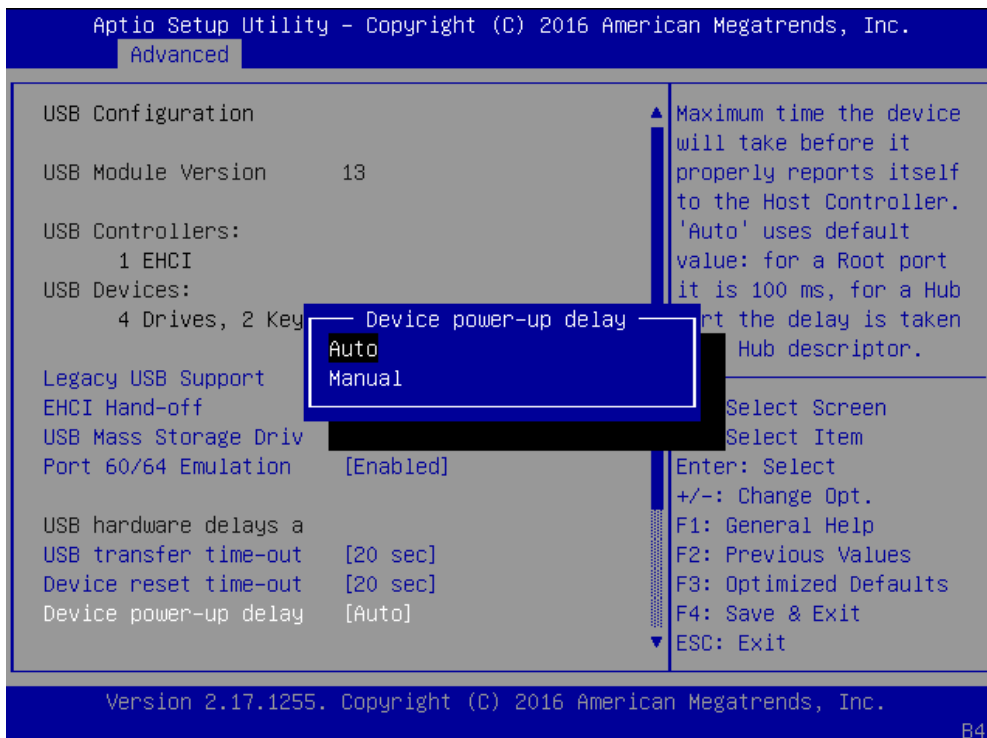

IntelRCSetup

Use [←] / [→] to select [IntelRCSetup] setup screen. Under this screen, you may use [↑] [↓] to select “Processor Configuration”, “Memory Configuration”, “PCH Configuration” or “PCH State after G3” to change the settings of CPU, memory and PCH functions.

Processor Configuration: displays and provides options to change processor settings. Press “Enter” to access its sub-menu.

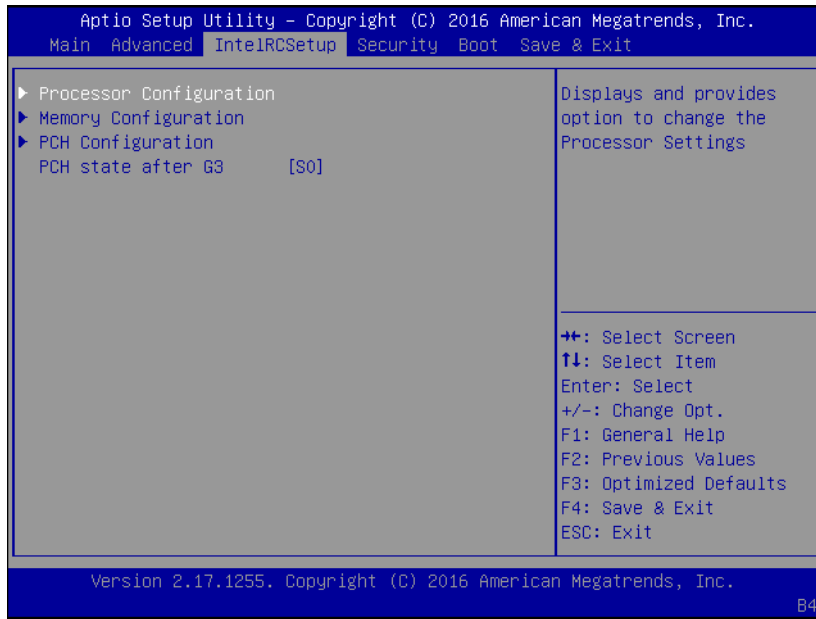

Under Process Configuration, information about the CPU including socket, ID, frequency and cache information will be displayed.

Execute Disable Bit: an Intel hardware-based protection against malicious code. It will detect the memory in which a code can be executed or not. When enabled, it will prevent certain classes of malicious buffer overflow attacks when combined with a supporting OS. When disabled, it forces the XD feature flag to always return 0.

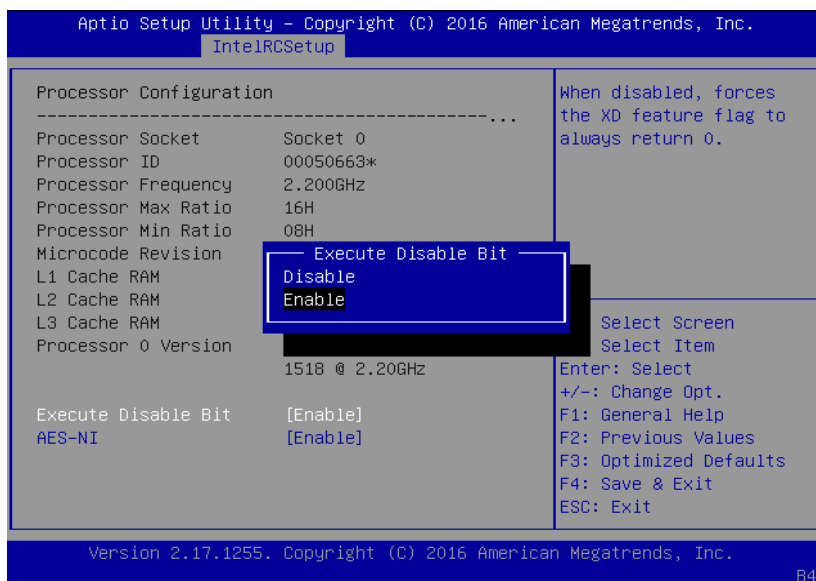

AES-NI: enables or disables AES-NI (Advanced Encryption Standard - New Instruction) support.

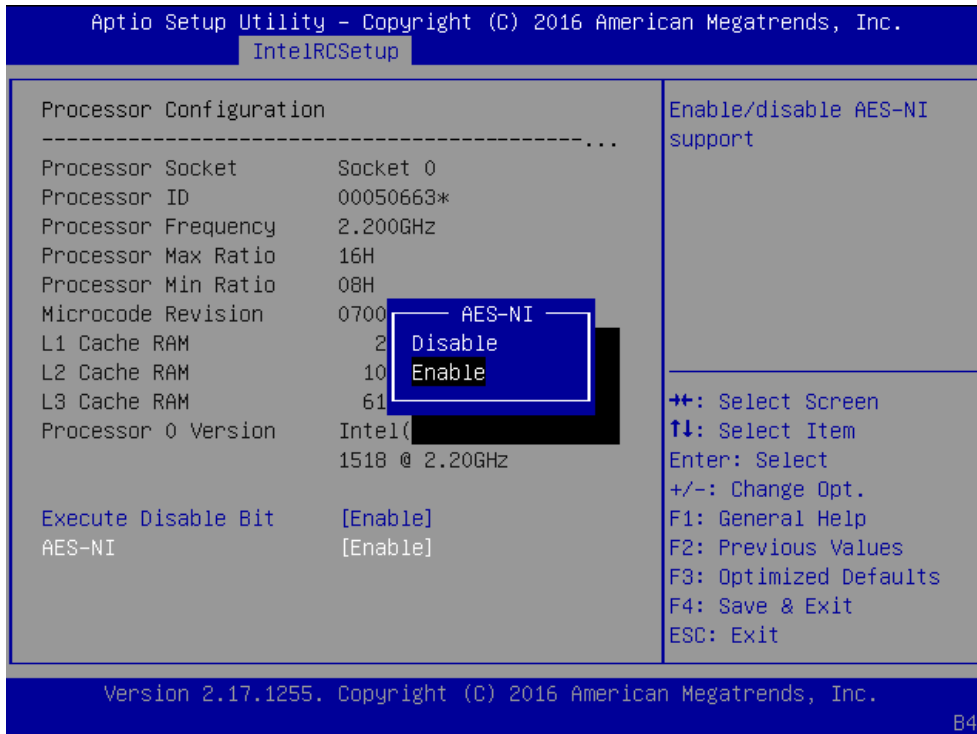

Memory Configuration

Memory Configuration displays and provides options to change the memory settings. You may press "Enter" to access the sub-menu.



Memory Topology: this option displays memory topology with DIMM population information. Each socket has 2 nodes/iMC's (numbered from 0 to 7). Each node supports up to 2 channels (0 and 1).

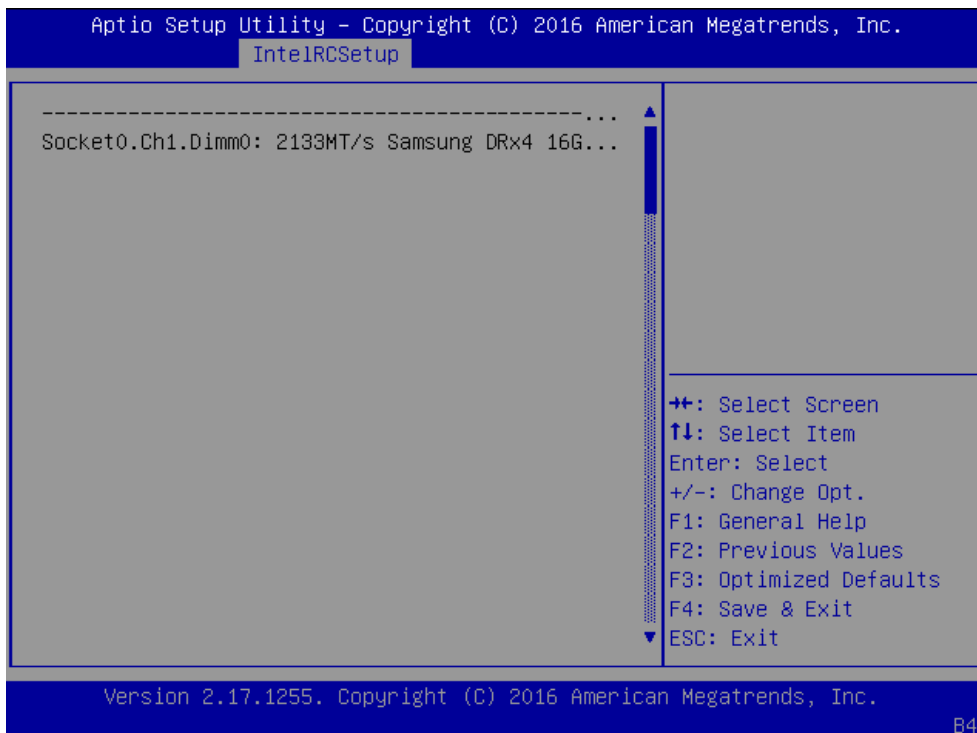
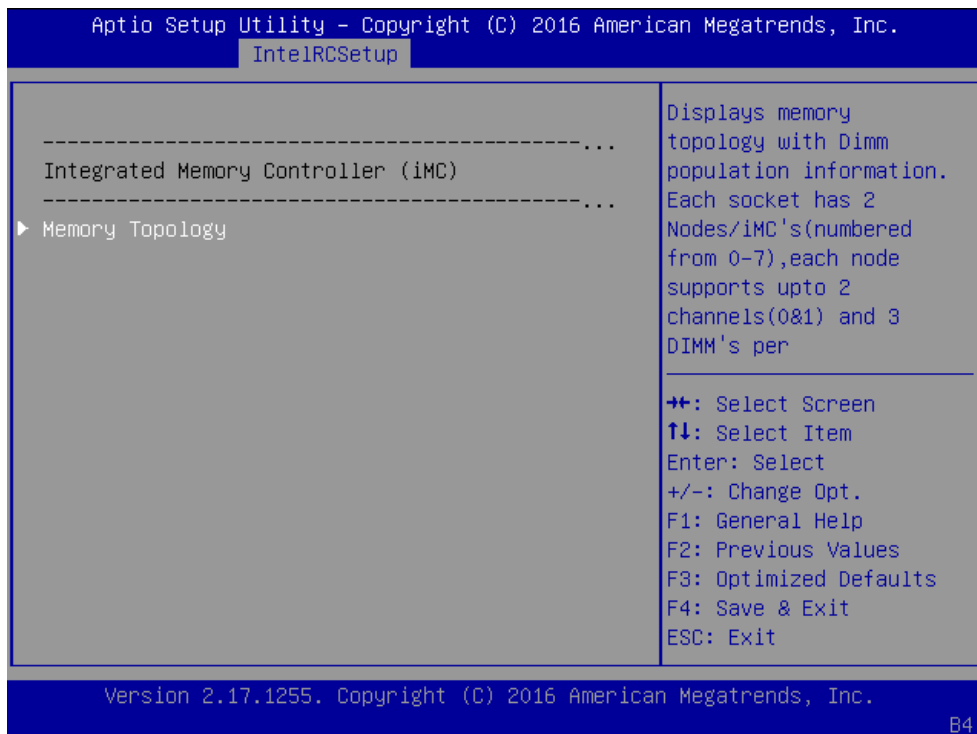

PCH Configuration

This function allows users to view and configure PCH settings. Press Enter to access the sub-menu.

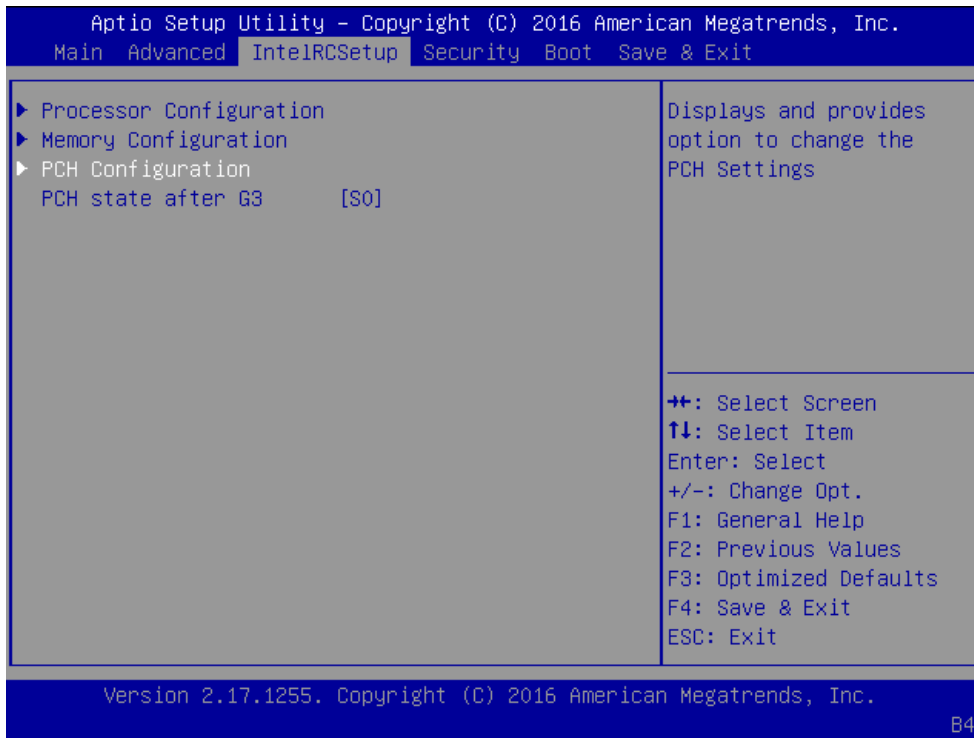

PCH SATA Configuration

Press Enter to access items for SATA devices and settings.

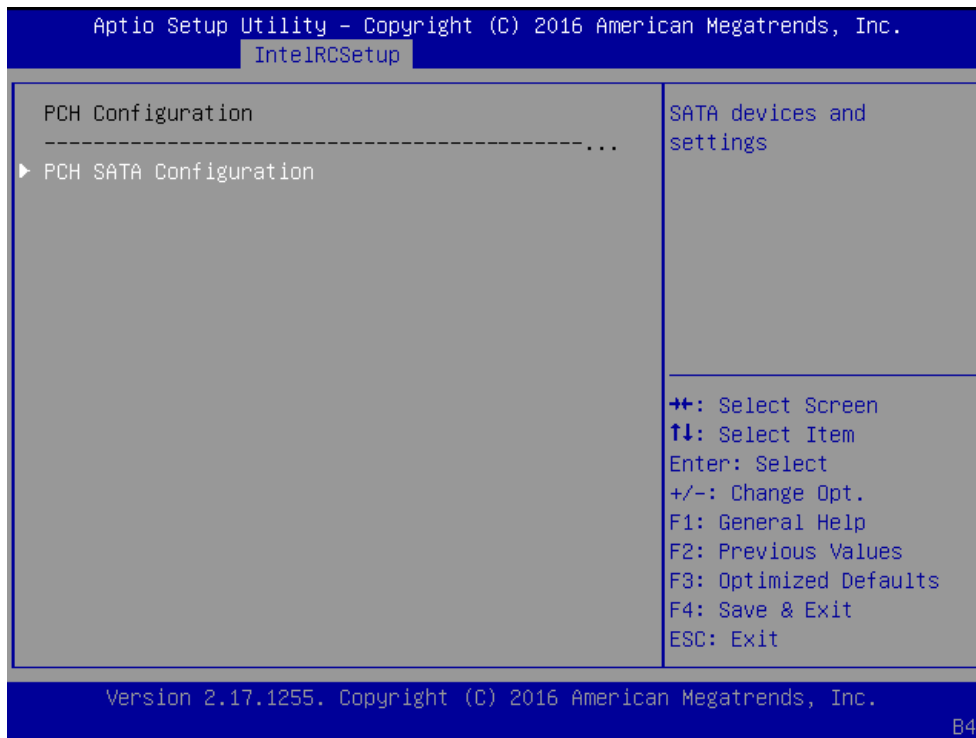

SATA Controller: enables or disables SATA controller

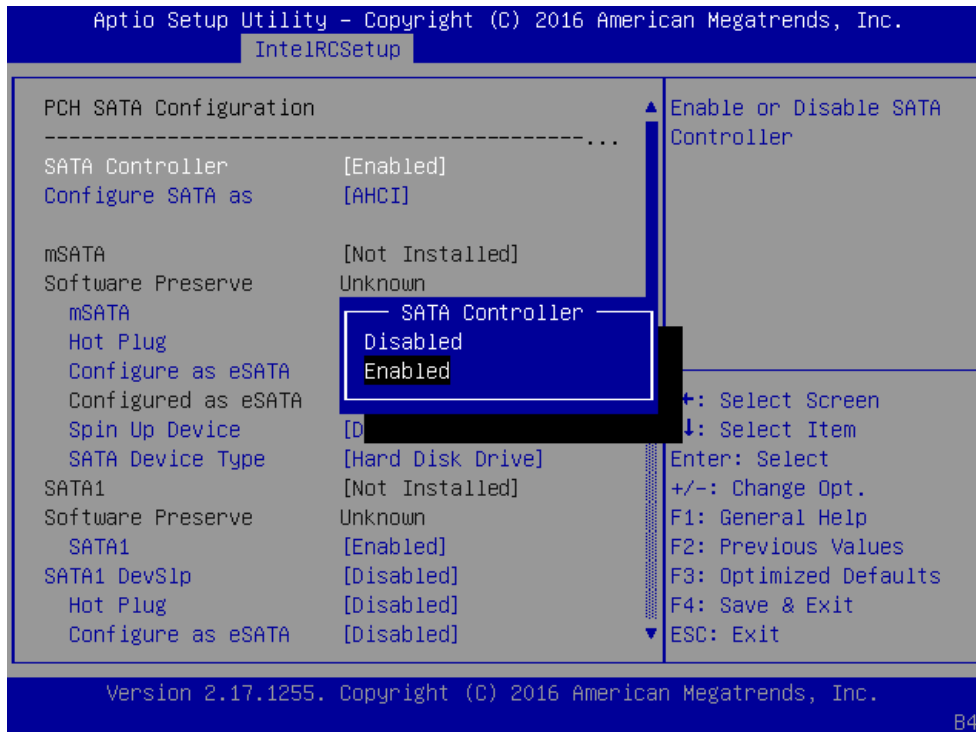

Configure SATA as: this item identifies whether the SATA port is connected to a SSD and HDD. Select IDE, AHCI or RAID. The default is "AHCI".

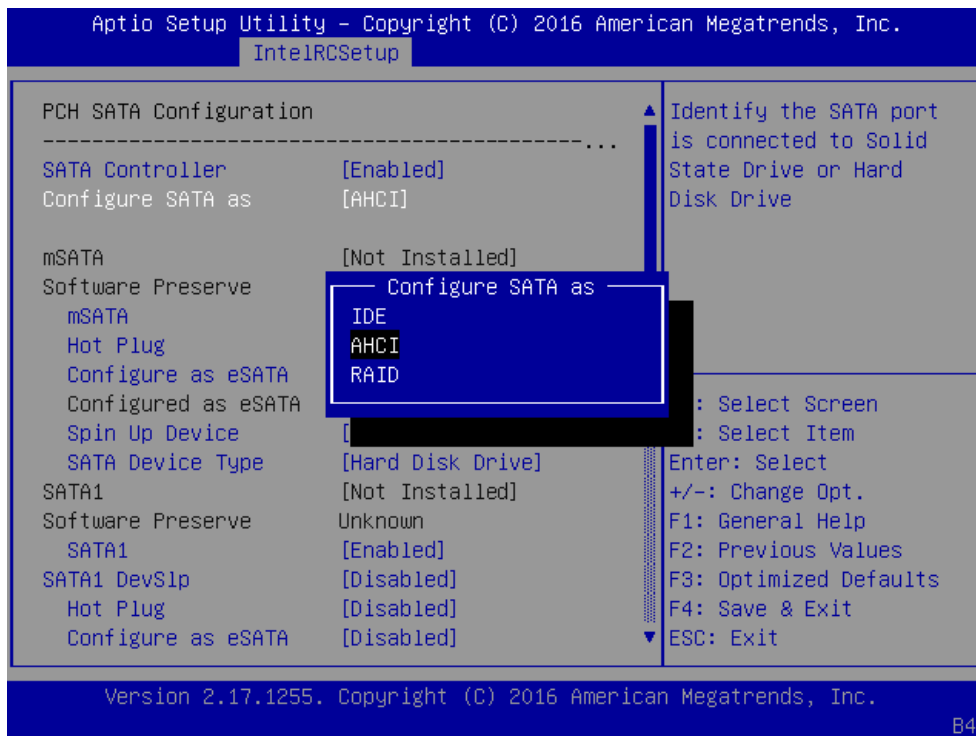

mSATA: displays status of mSATA storage device

Software Preserve: displays information of Software Preserve

mSATA: enable or disable mSATA socket

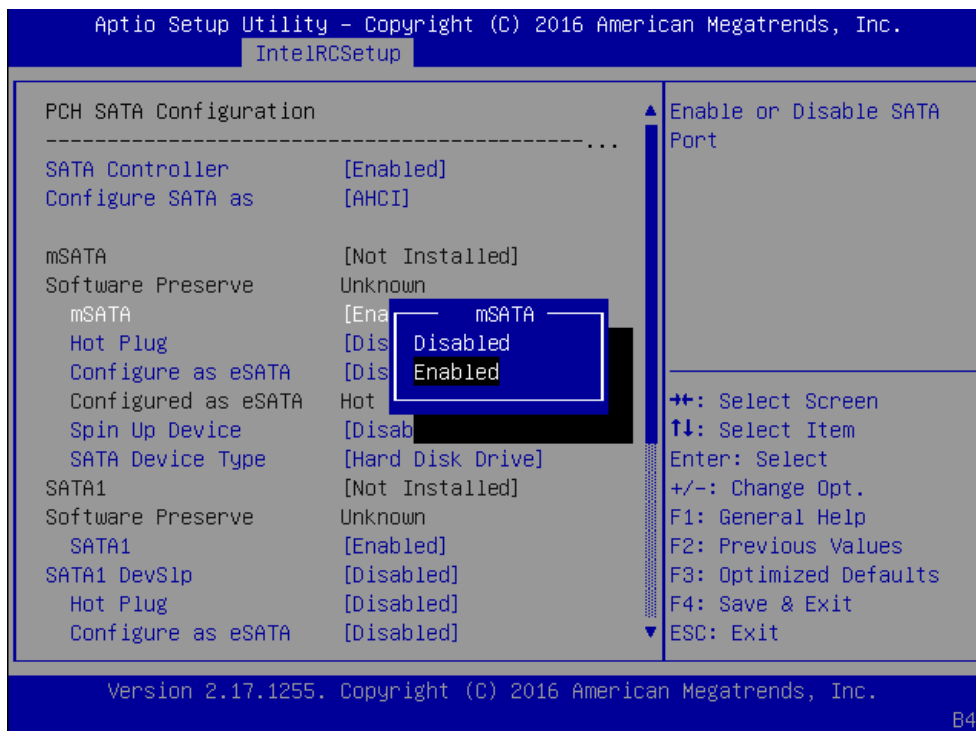

Hot Plug: designates this port as hot pluggable

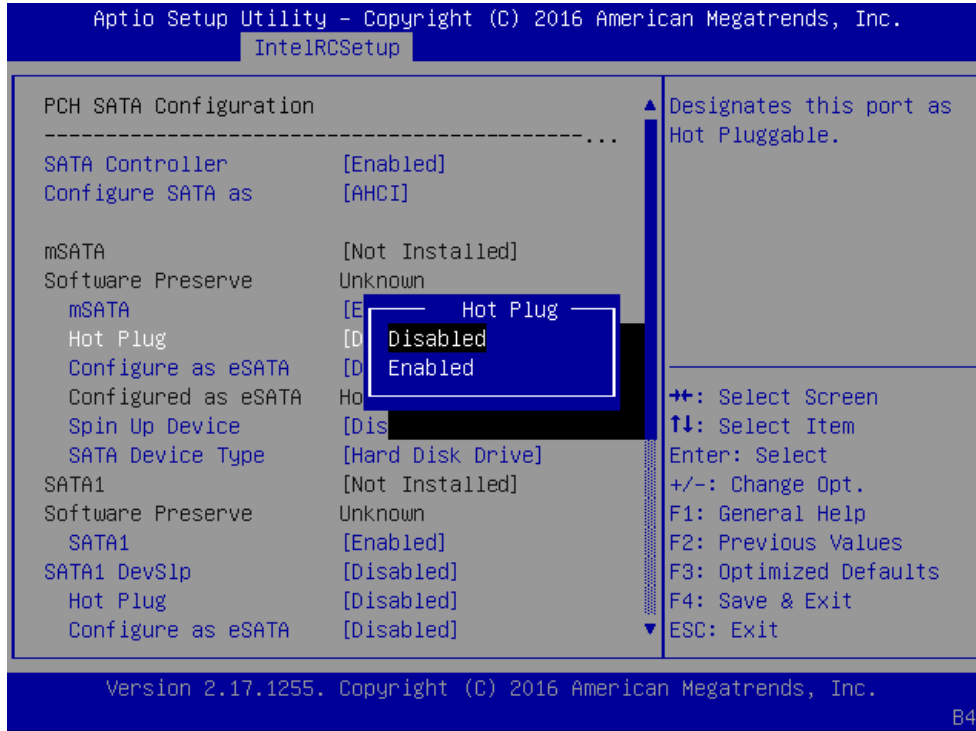

Configure as eSATA: configures the port as External SATA (eSATA)

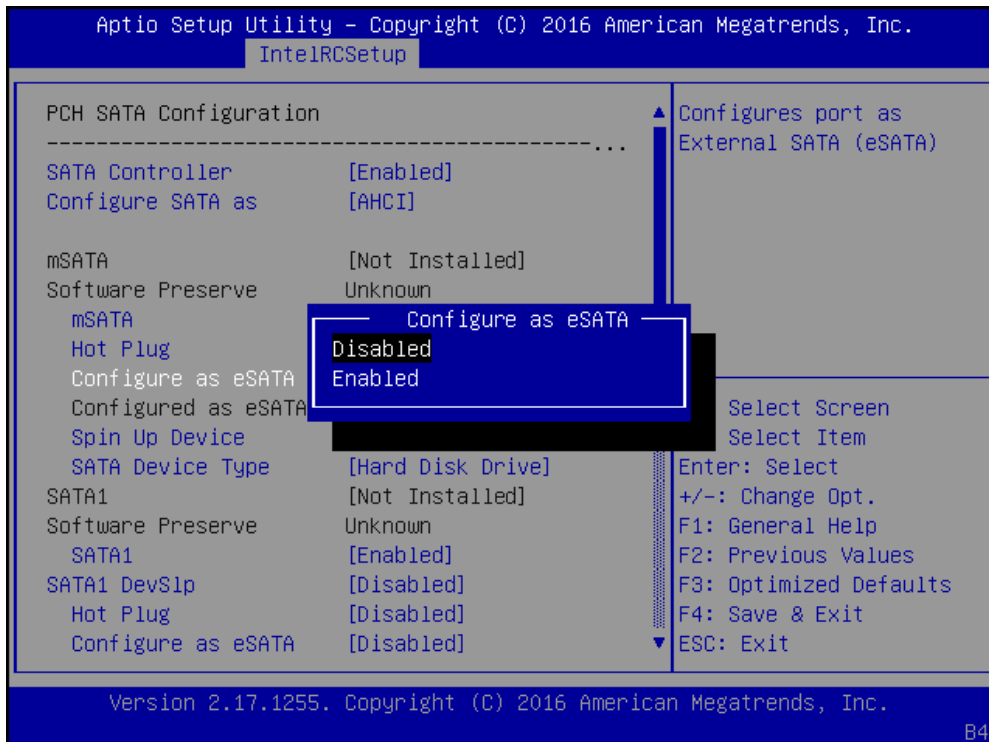

Spin Up Device: if enabled for any of ports, Staggered Spin Up will be performed and only the drives which have this option enabled will spin up at boot. Otherwise all drives spin up at boot.

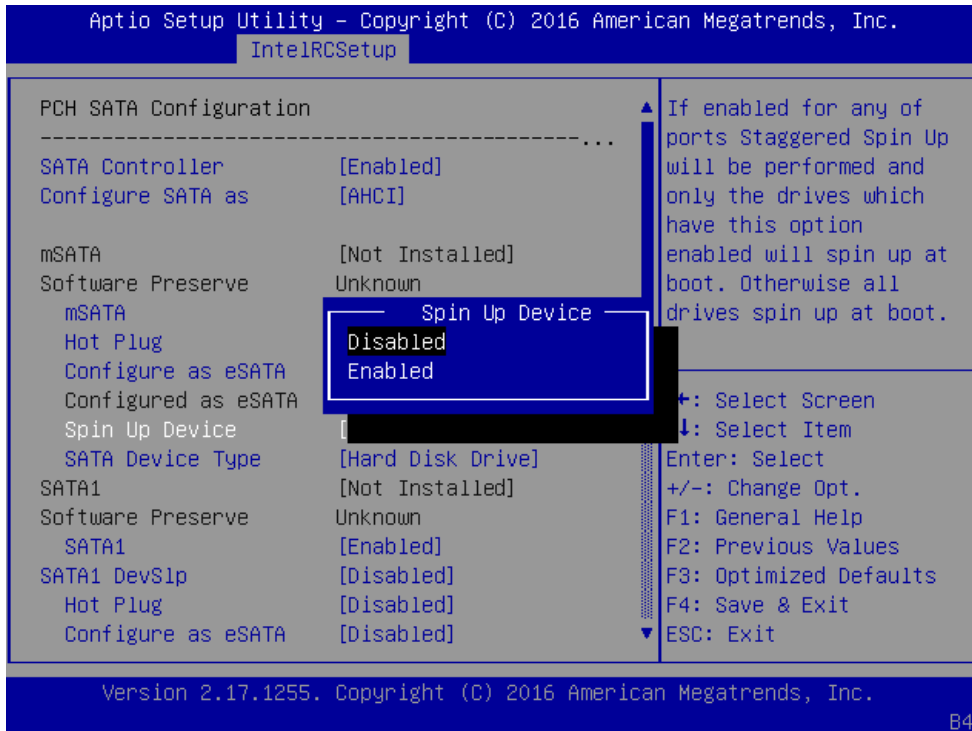

SATA Device Type: identifies the SATA port is connected to SSD (Solid State Drive) or HDD (Hard Disk Drive).

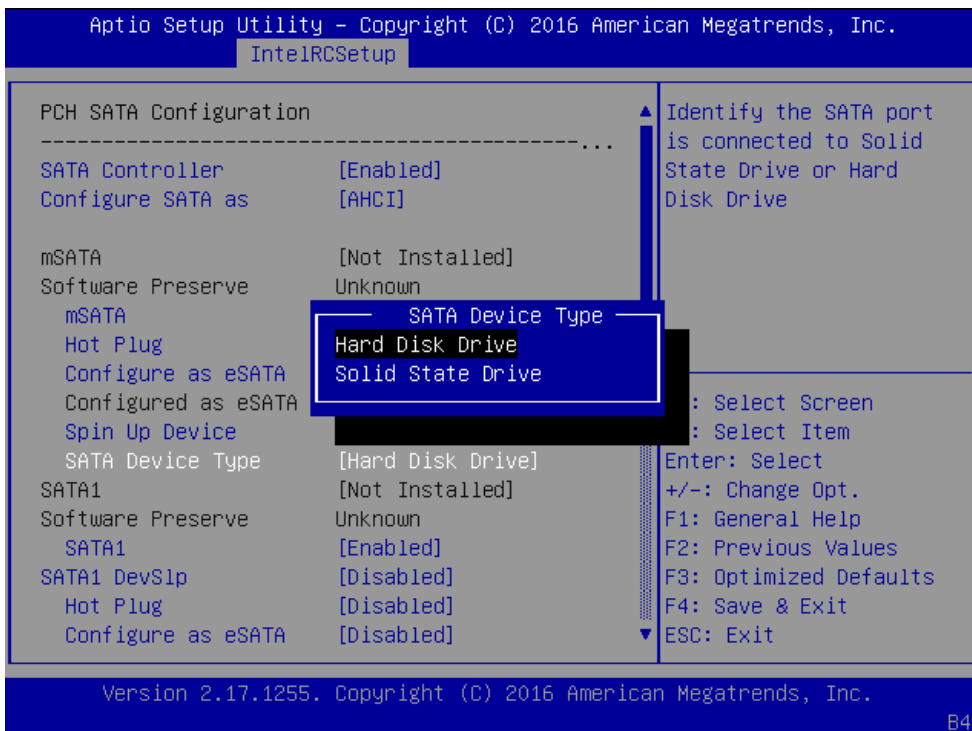

SATA1: enable or disable the SATA port

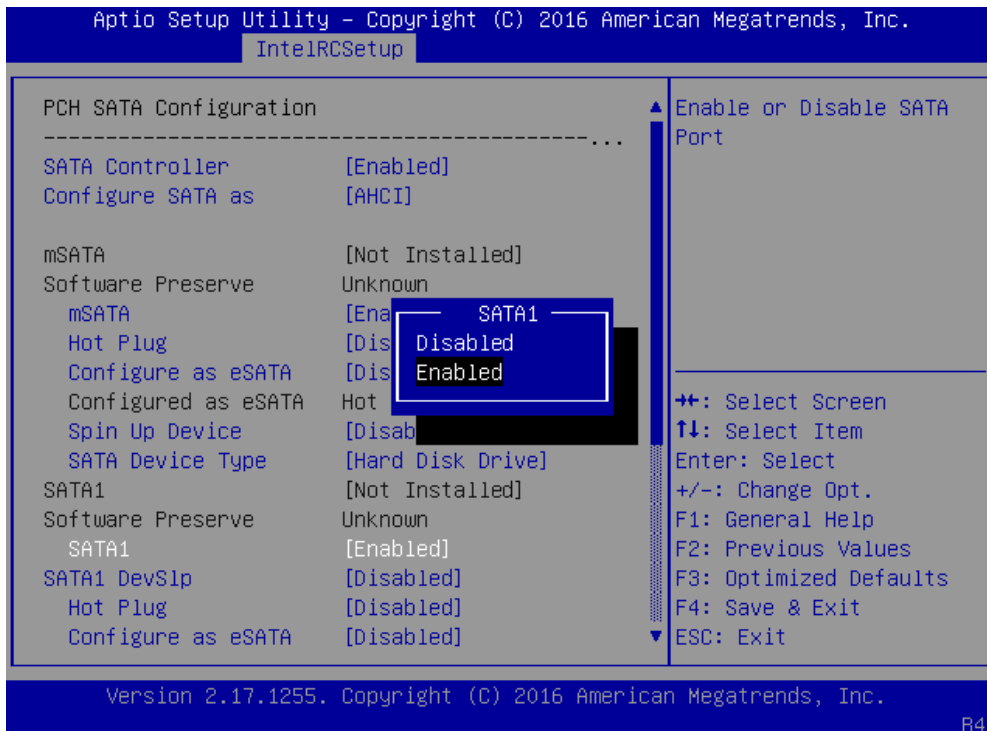

SATA1 DevSlp: enable or disable the SATA port Device Sleep. Board rework for LP is needed before enabling this power-saving function.

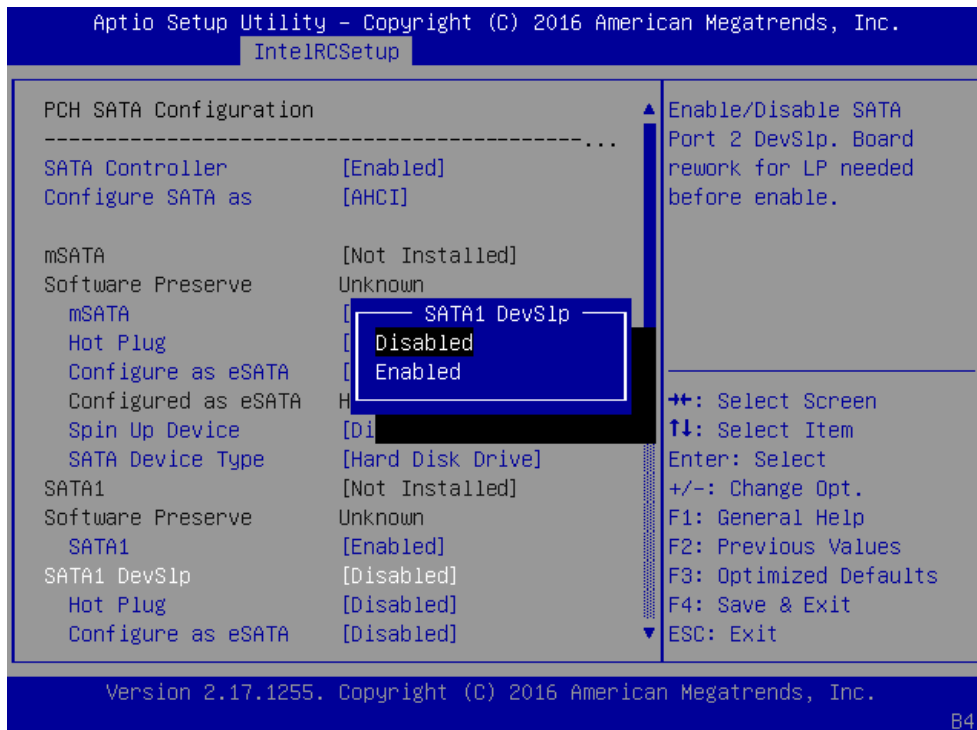

Hot Plug: designates this port as hot pluggable

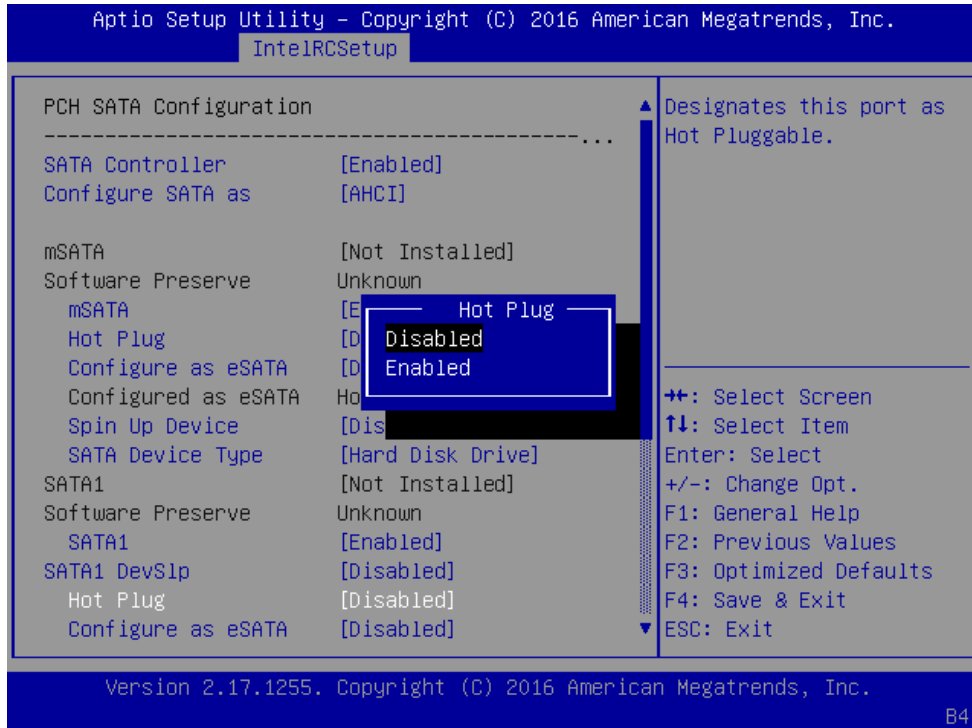

Configure as eSATA: configures the port as External SATA (eSATA)

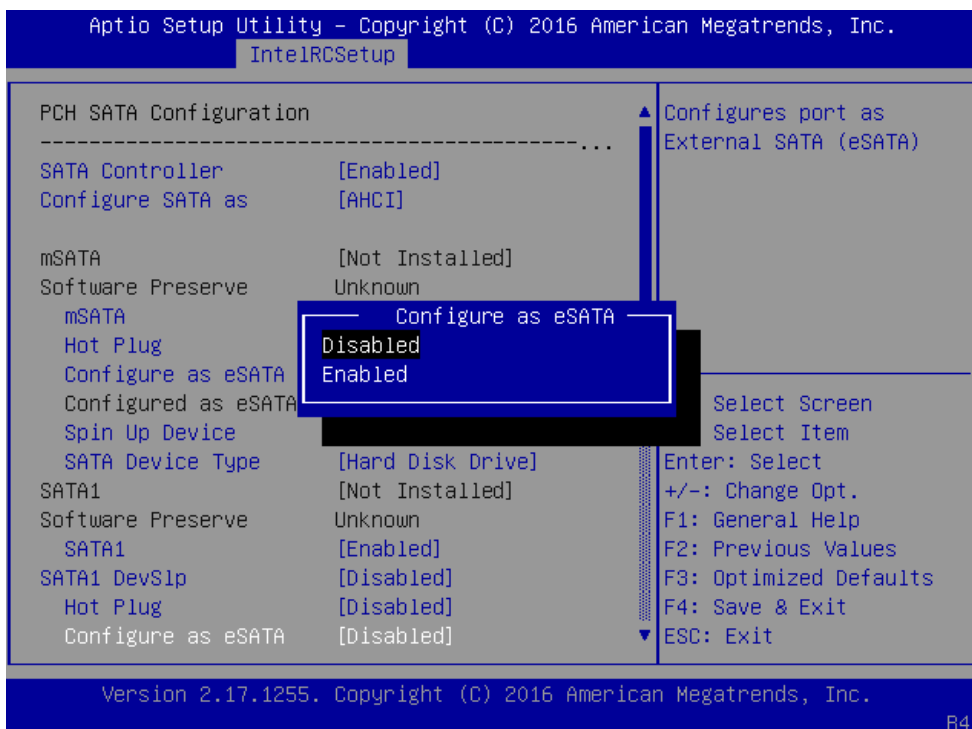

Spin Up Device: if enabled for any of ports, Staggered Spin Up will be performed and only the drives which have this option enabled will spin up at boot. Otherwise all drives spin up at boot.

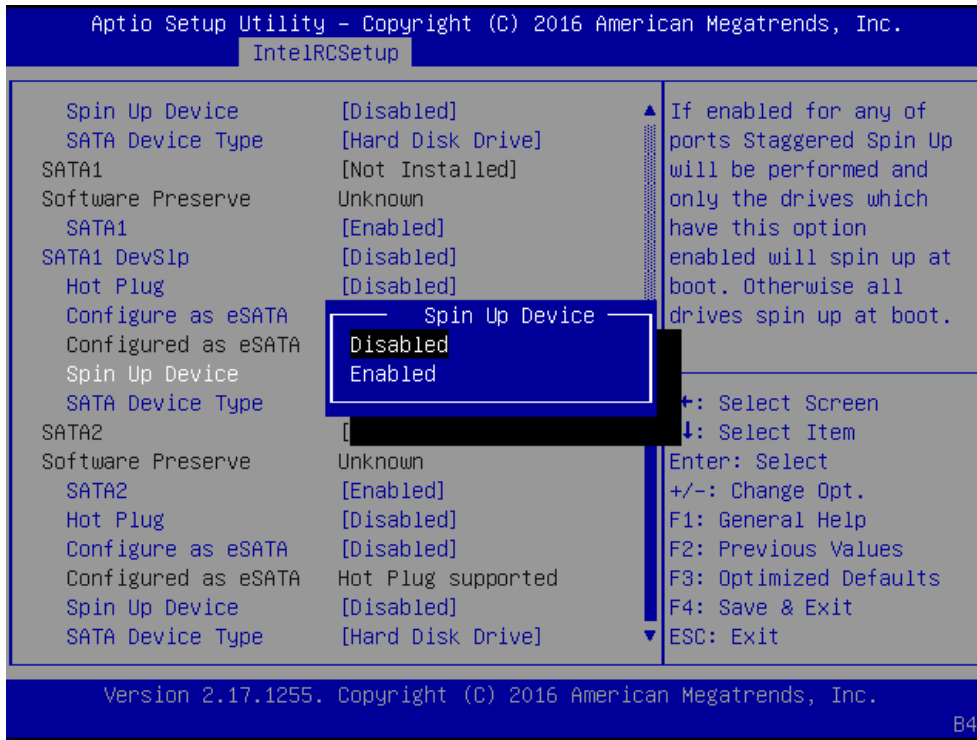

SATA Device Type: identifies the SATA port is connected to SSD (Solid State Drive) or HDD (Hard Disk Drive).

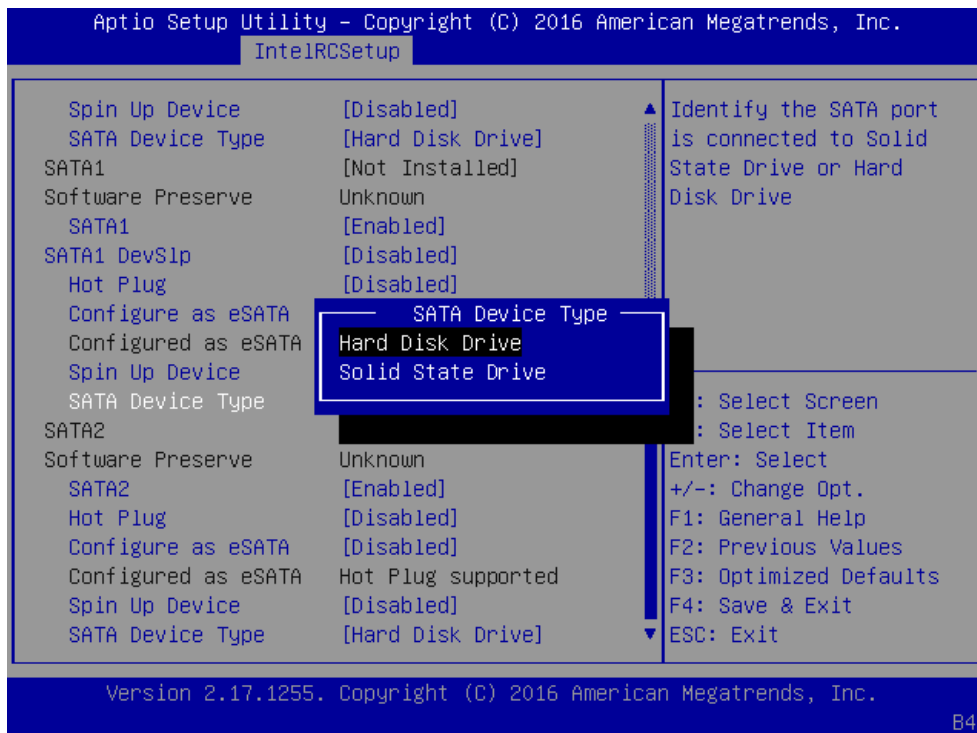

SATA2: enable or disable the SATA port

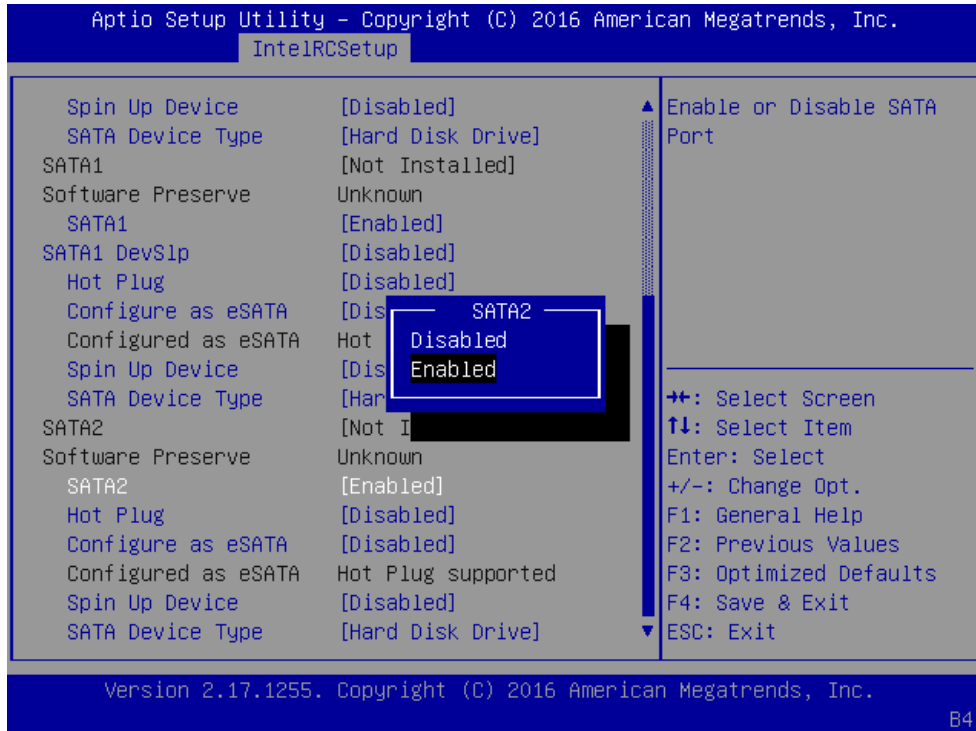

Hot Plug: designates this port as hot pluggable

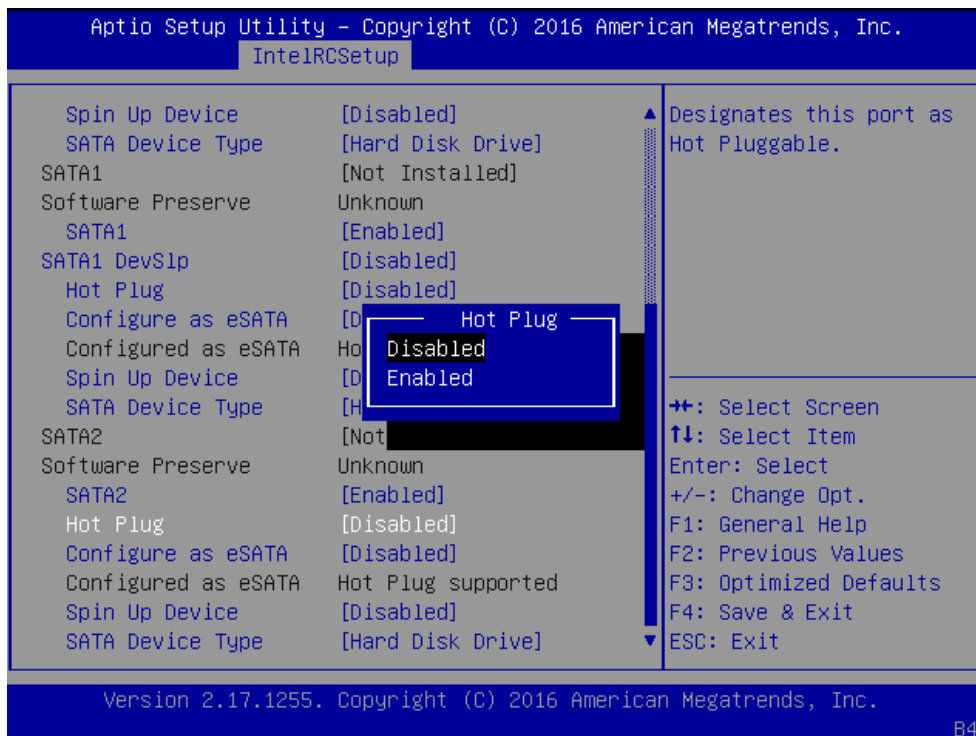

Configure as eSATA: configures the port as External SATA (eSATA)

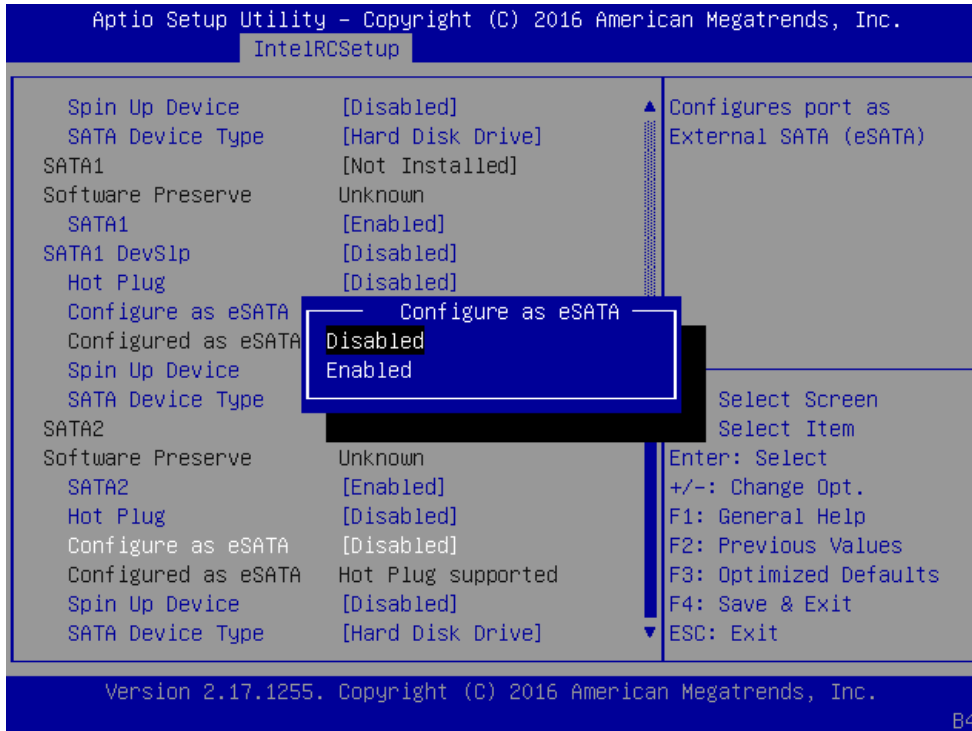

Spin Up Device: if enabled for any of ports, Staggered Spin Up will be performed and only the drives which have this option enabled will spin up at boot. Otherwise all drives spin up at boot.

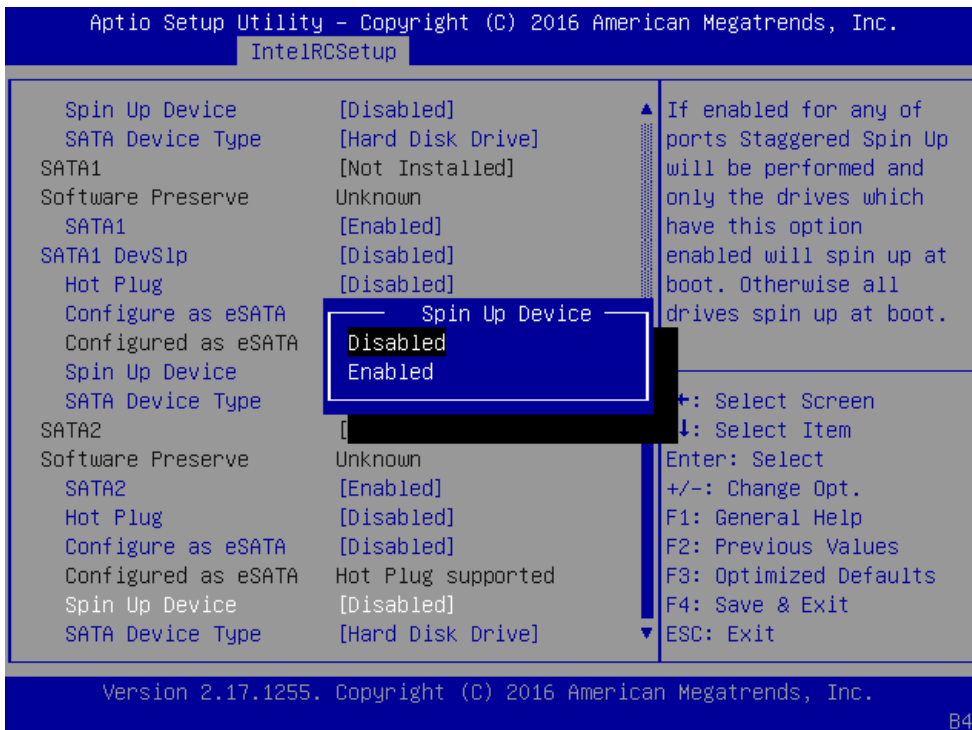

SATA Device Type: identifies the SATA port is connected to SSD (Solid State Drive) or HDD (Hard Disk Drive).

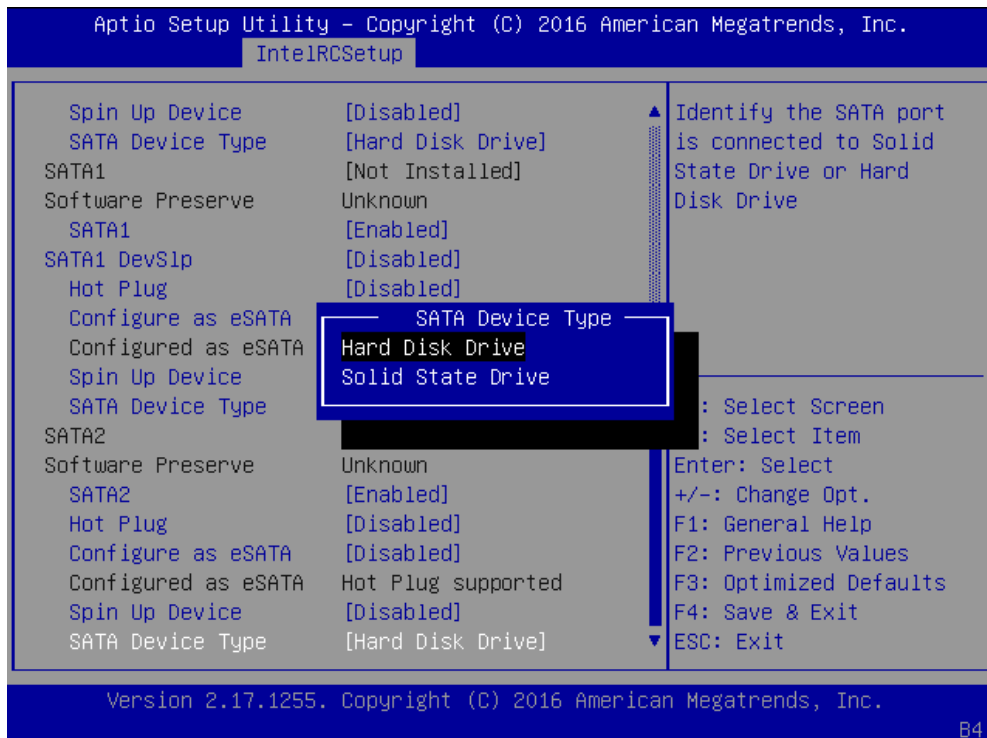

PCH State after G3:

Select S0/S5 for ACPI state after a G3. The choices are "S0", "S5" or "Last State".

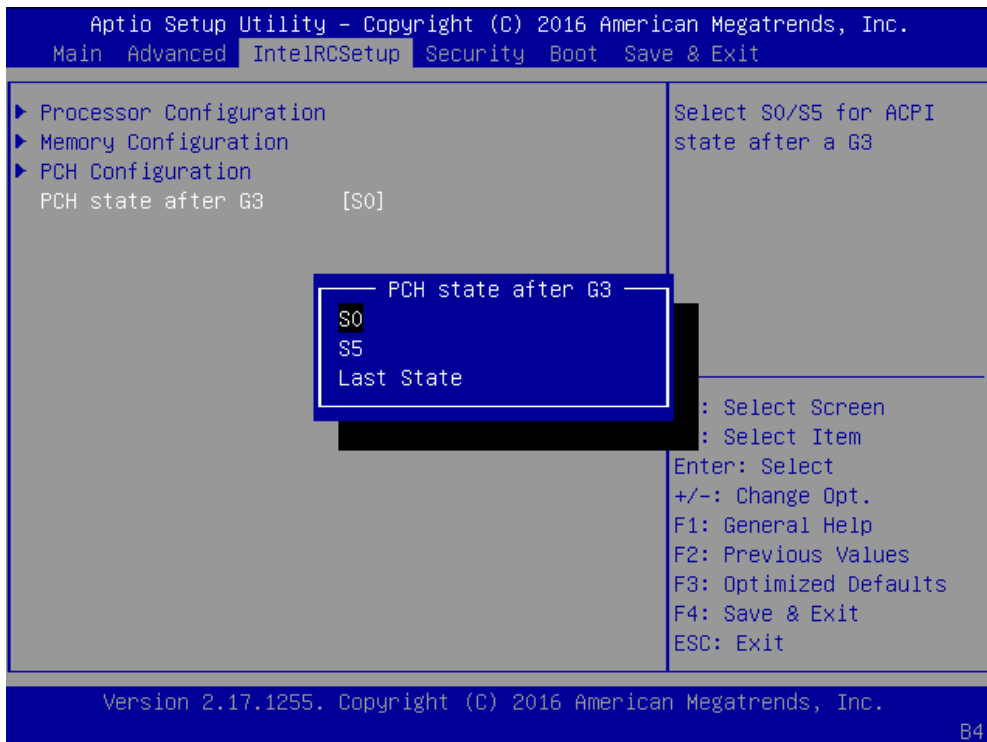

Security

Use [←] / [→] to select [Security] setup screen. Under this screen, you may use [↑] [↓] to select an item you want to configure.

Administrator Password: set administrator password. Once set, then this only limits access to Setup and is only asked for when entering Setup.

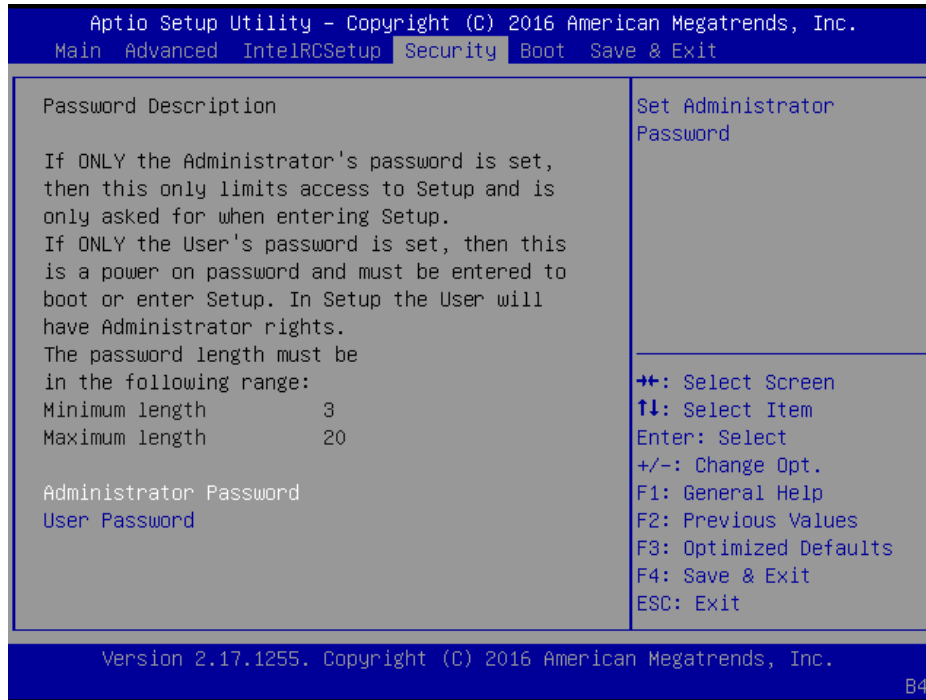

User Password: set user password. Once set, then this is a power-on password and must be entered to boot or enter Setup. In Setup, the user will have Administrator rights.

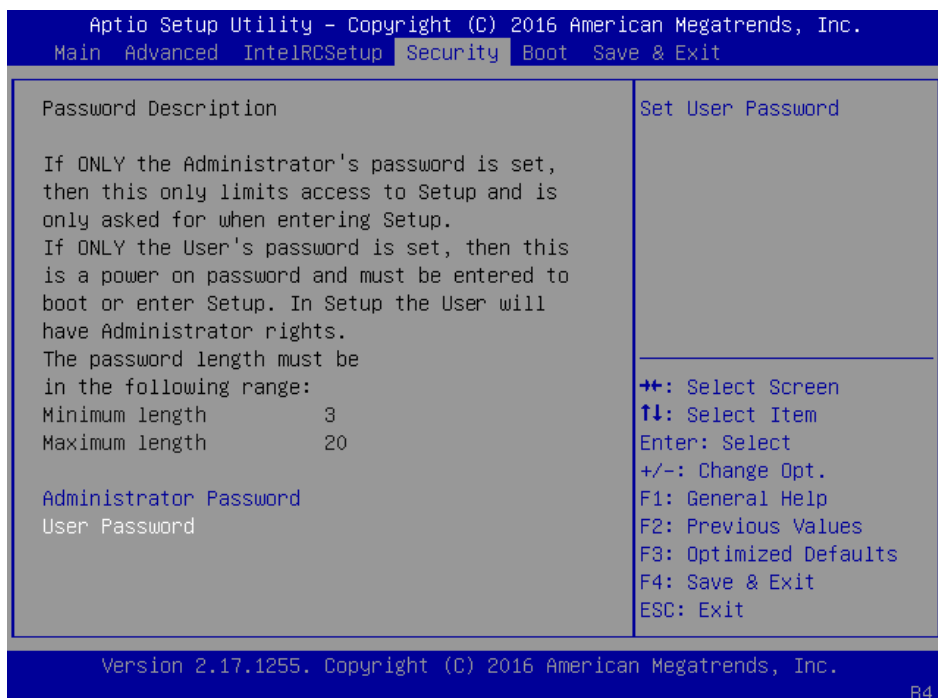

Boot

Use [←] / [→] to select [Boot] setup screen. Under this screen, you may use [↑] [↓] to select an item you want to configure.

Boot Configuration

Setup Prompt Timeout: number of seconds to wait for setup activation key. "65535 (0xFFFF)" means indefinite waiting.

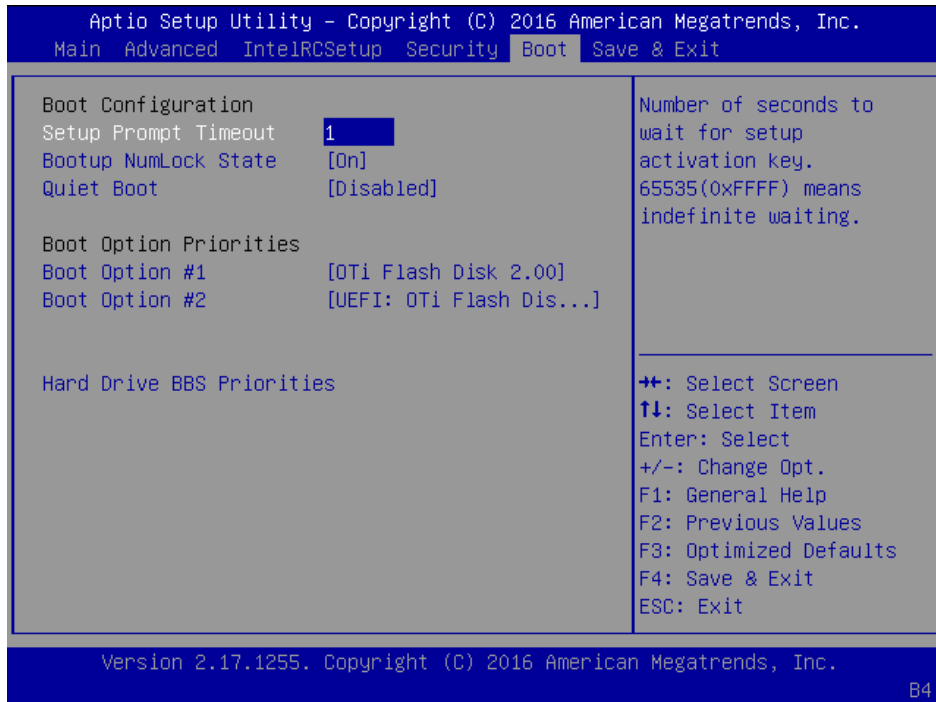

Bootup Numlock State: select the keyboard "Numlock" state

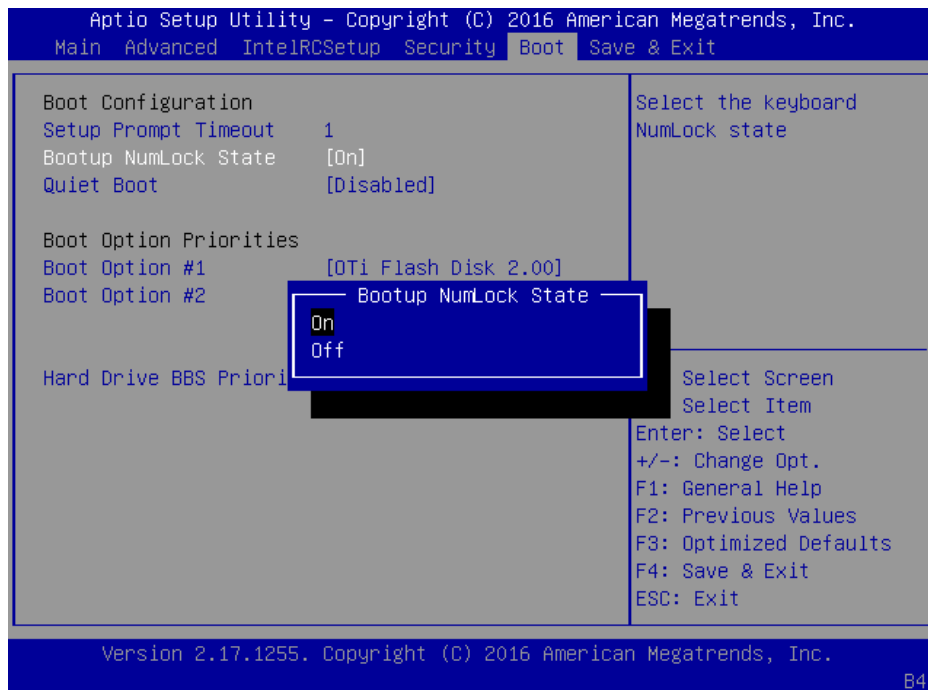

Quiet Boot: this option allows you to enable or disable “Quiet Boot”. The default is “Disabled” based on Intel’s server environment setting.

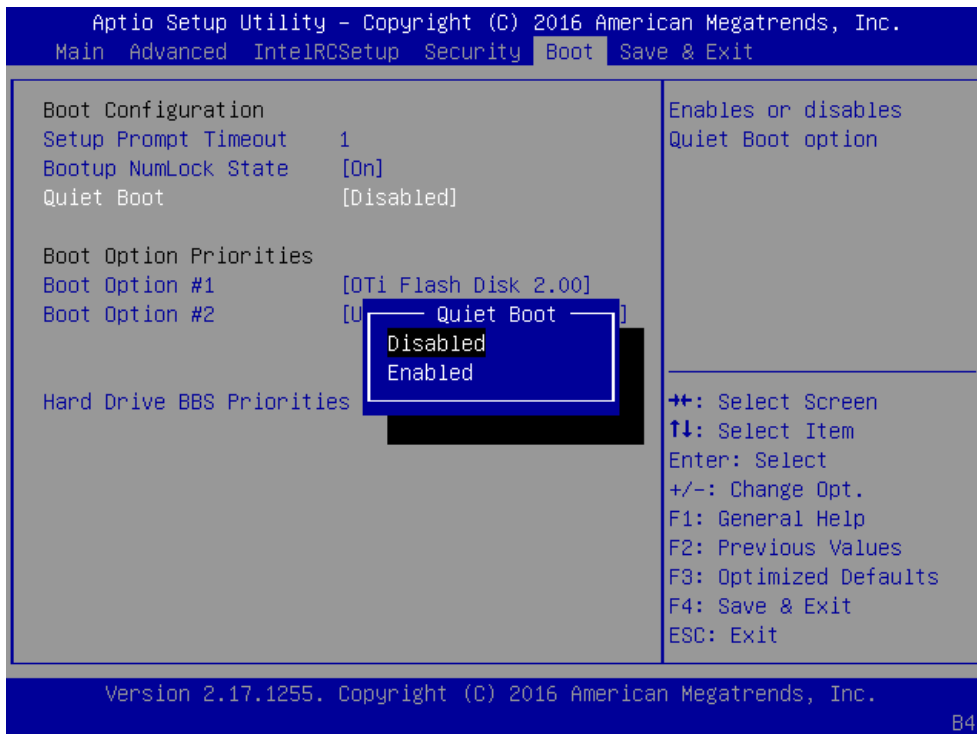

Boot Option Priorities

Boot Option #1/2: set devices as boot option #1/2 for the system boot order

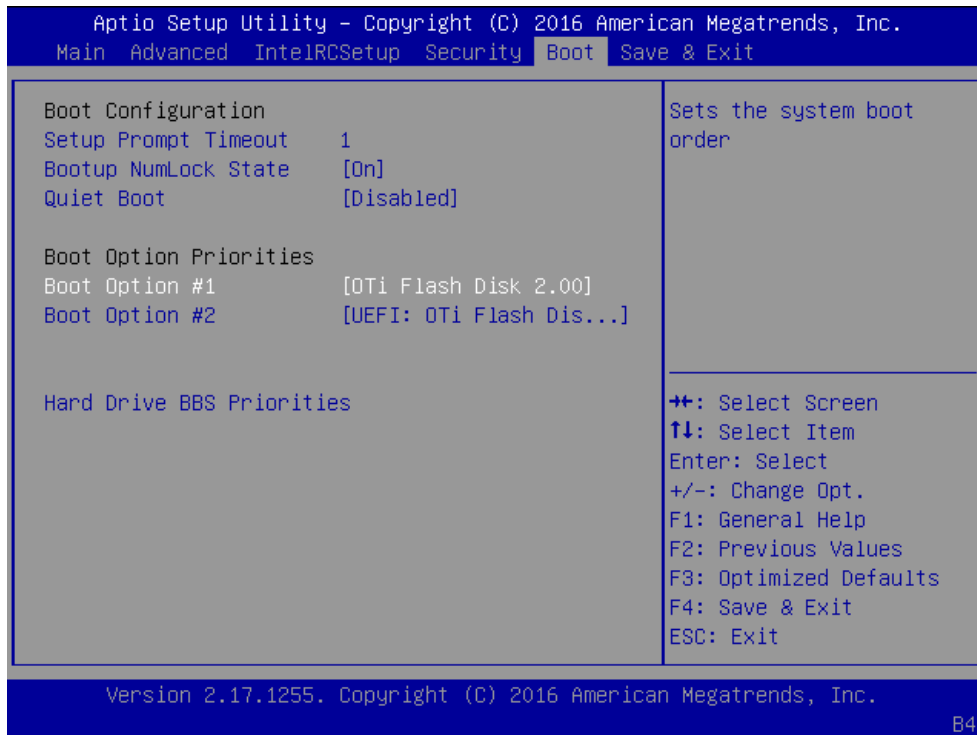

USB Device BBS Priorities: set the order of the legacy devices in this group

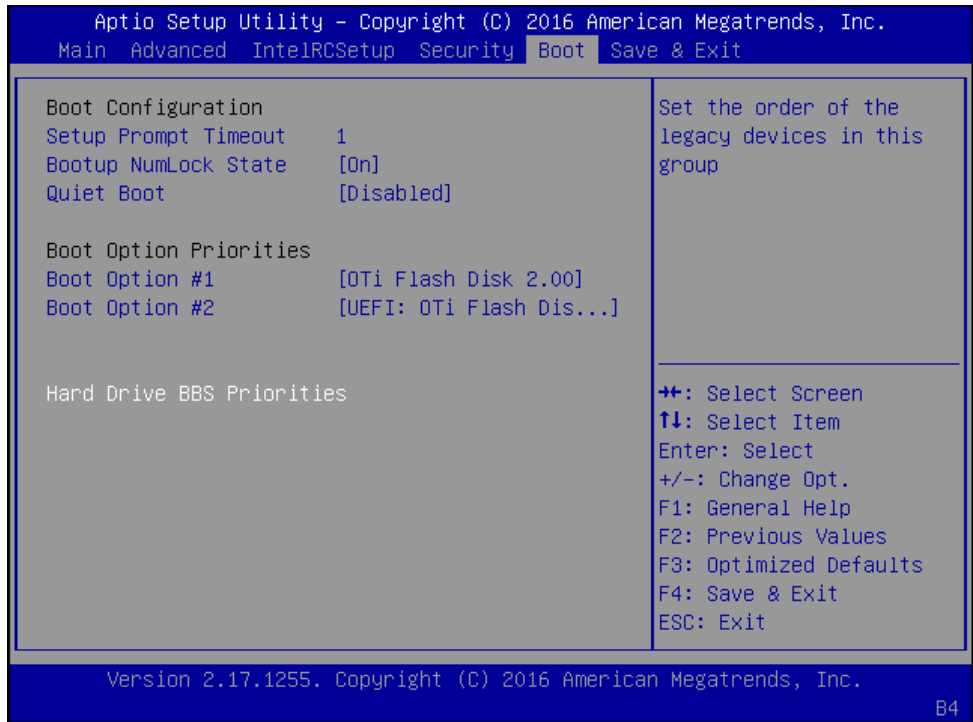

Save & Exit

Use [←] / [→] to select [Save & Exit] setup screen. Under this screen, you may use [↑] [↓] to select an item you want to configure.

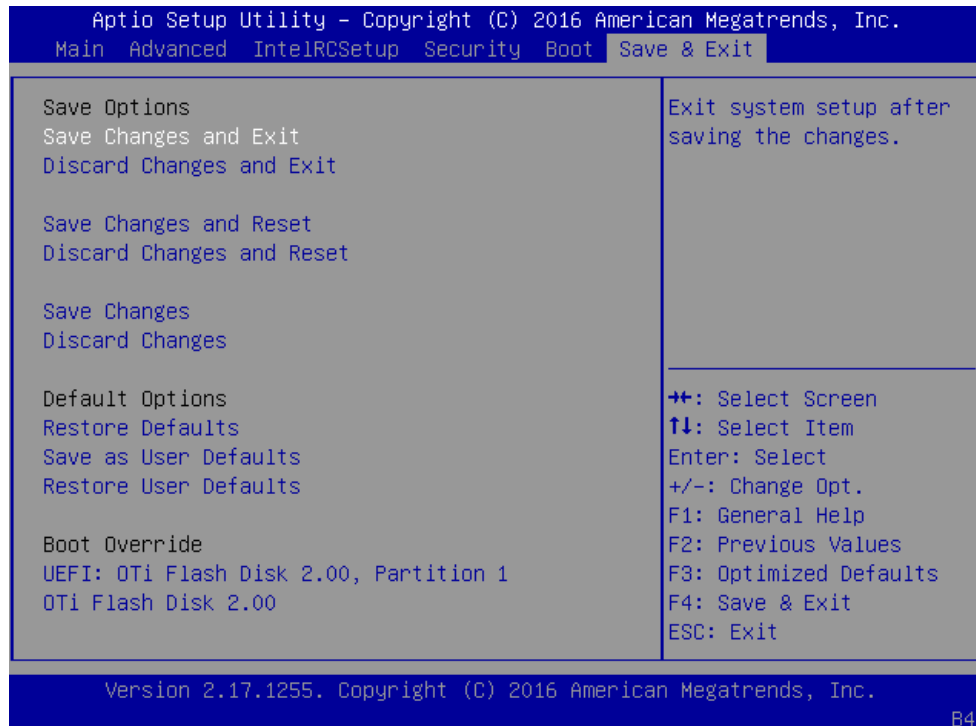

Save Changes and Exit: exit system setup after saving the configuration changes

Discard Changes and Exit: exit system setup without saving the configuration changes

Save Changes and Reset: reset the system after saving the configuration changes

Discard Changes and Reset: reset the system without saving the configuration changes

Save Options

Save Changes: save the configuration changes

Discard Changes: discard all the configuration changes

Restore Defaults: restore to factory default setting

Save as User Defaults: save changes as the new user default

Restore User Defaults: restore the user default

Boot Override

UEFI: OTi Flash Disk 2.00, Partition 1

OTi Flash Disk 2.00

Save Changes and Exit: exit system setup after saving the configuration changes

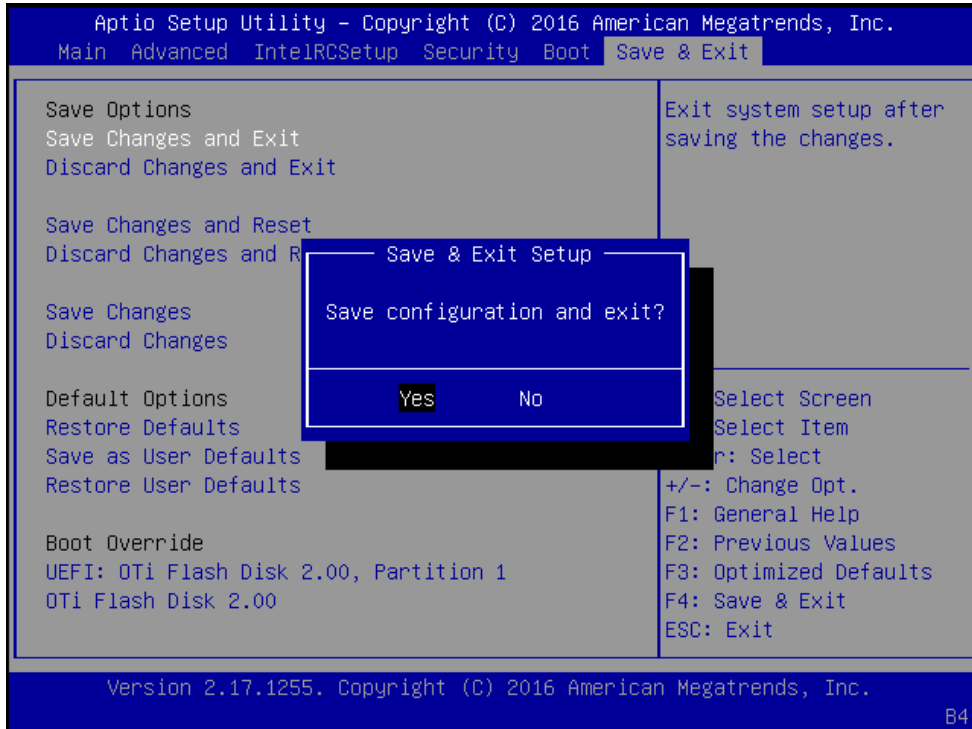

Discard Changes and Exit: exit system setup without saving the configuration changes

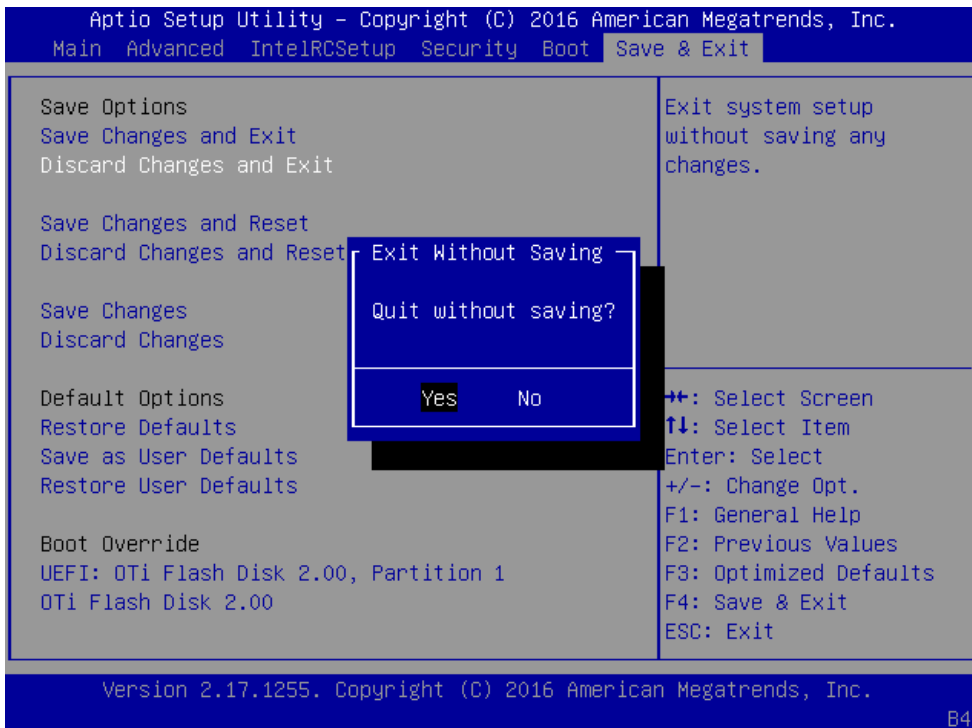

Save Changes and Reset: reset the system after saving the configuration changes

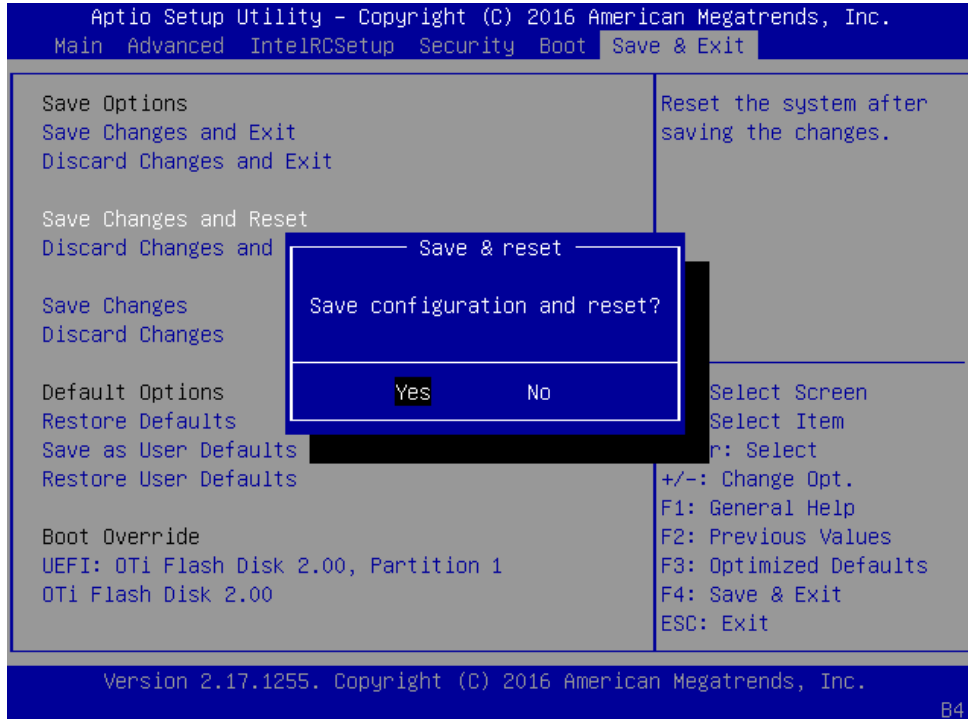

Discard Changes and Reset: reset the system without saving the configuration changes

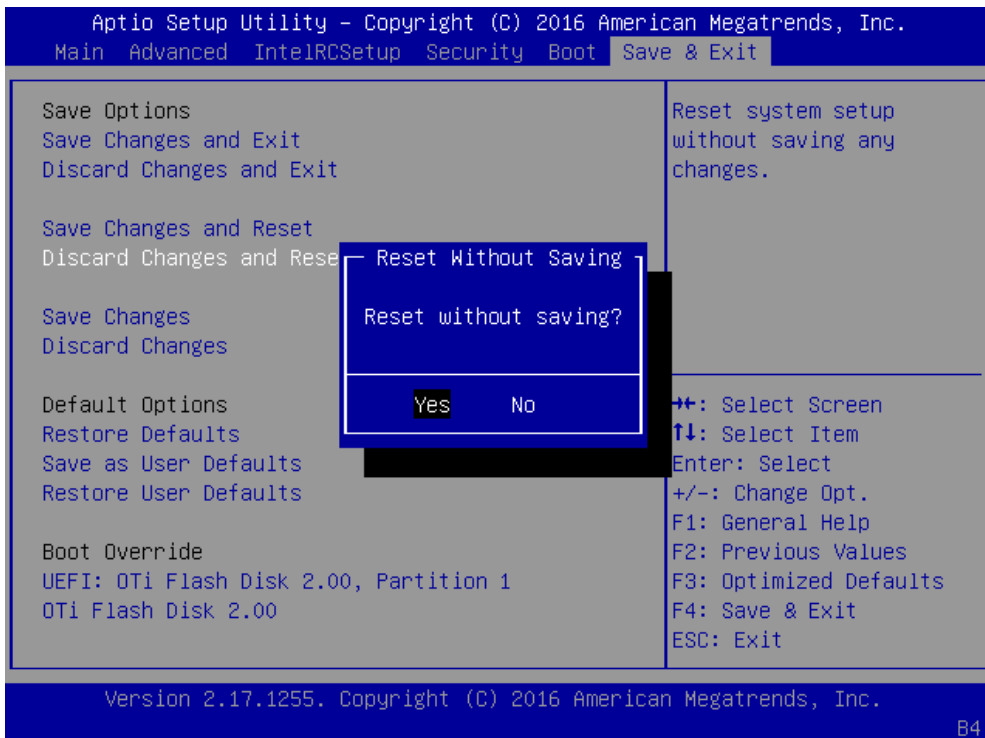

Save Changes: save the configuration changes done so far

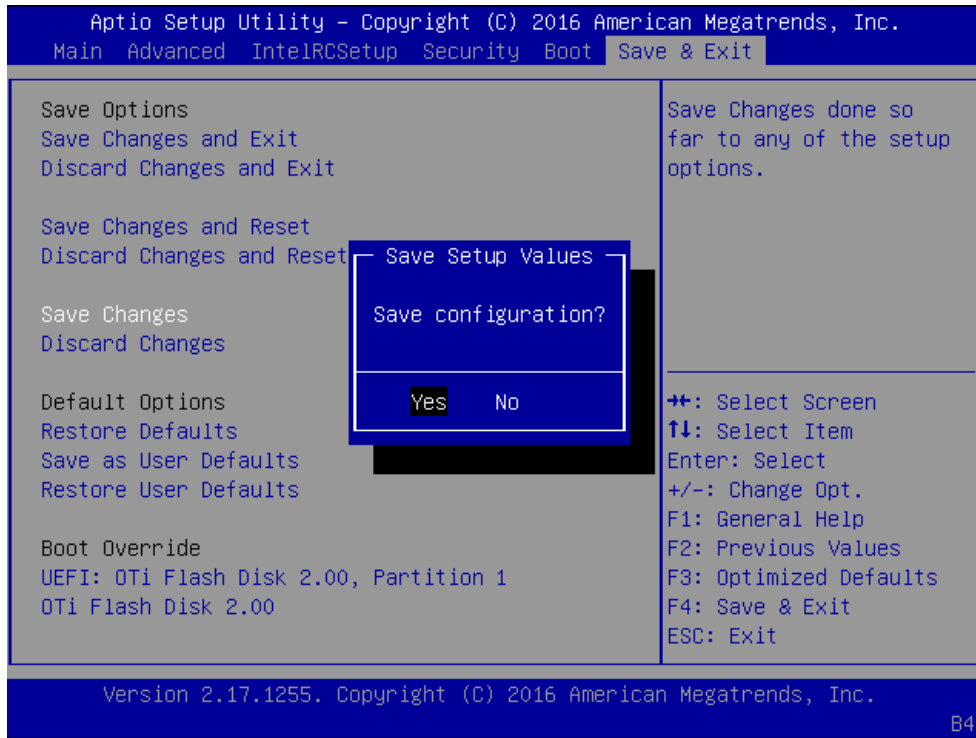

Discard Changes: discard all the configuration changes

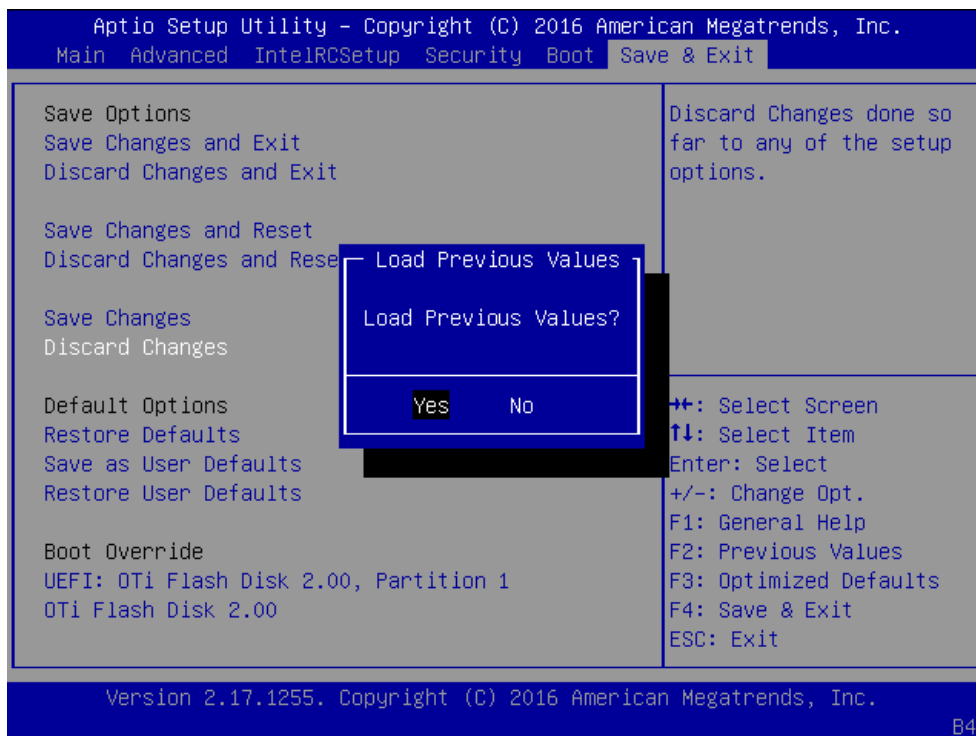

Restore Defaults: restore/load factory default setting for all setup parameters.

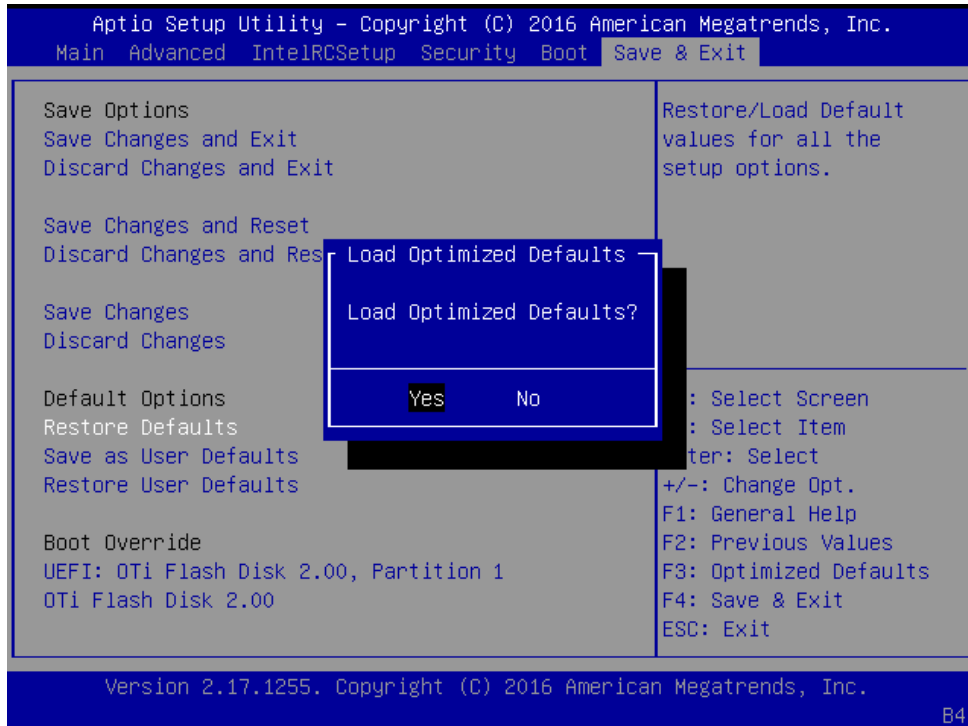

Save as User Defaults: save changes done so far as user default

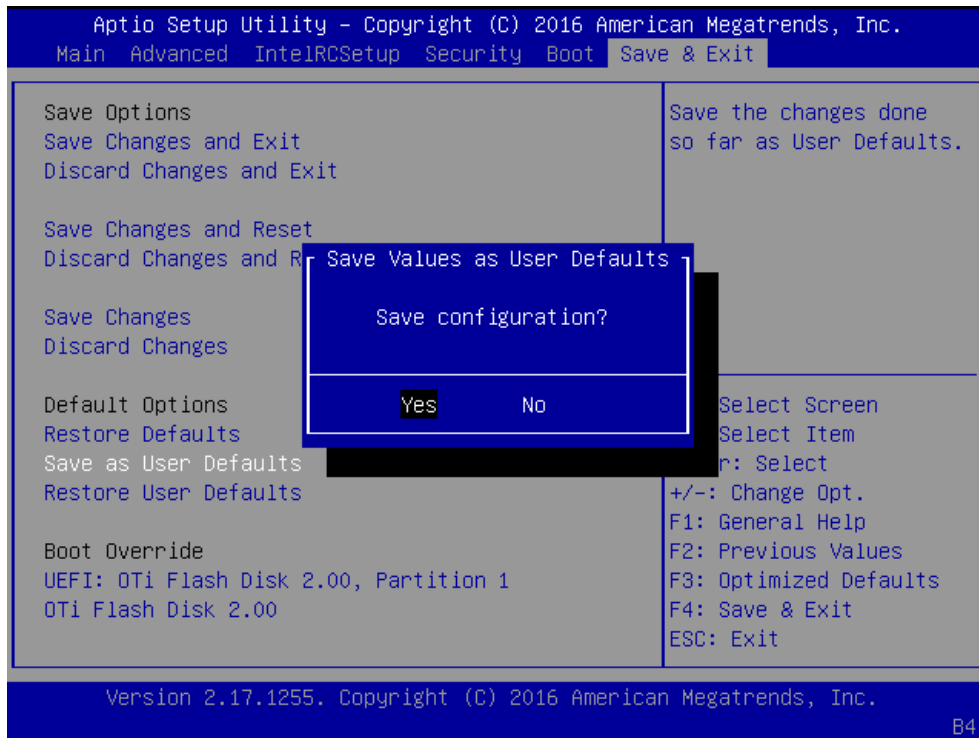

Restore User Defaults: restore the user default

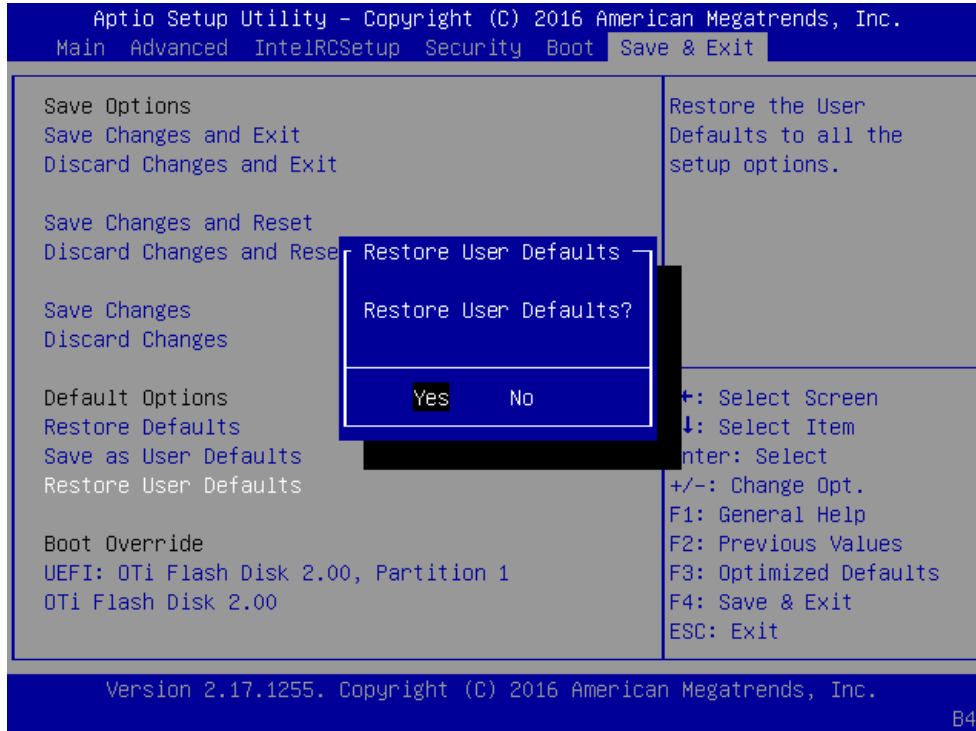

Appendix A: Programming Watchdog Timer

A watchdog timer is a piece of hardware that can be used to automatically detect system anomalies and reset the processor in case there are any problems. Generally speaking, a watchdog timer is based on a counter that counts down from an initial value to zero. The software selects the counter's initial value and periodically restarts it. Should the counter reach zero before the software restarts it, the software is presumed to be malfunctioning and the processor's reset signal is asserted. Thus, the processor will be restarted as if a human operator had cycled the power.



Appendix B: Setting up Console Redirection

Console redirection lets you monitor and configure a system from a remote terminal computer by re-directing keyboard input and text output through the serial port. These following steps illustrate how to use this feature. The BIOS of the system allows the redirection of console I/O to a serial port. With this configured, you can remotely access the entire boot sequence through a console port.

1. Connect one end of the console cable to console port of the system and the other end to serial port of the Remote Client System.
2. Configure the following settings in the BIOS Setup menu:
BIOS > Advanced > Remote Access Configuration > Serial Port Mode > [115200, 8 , n ,1]
3. Configure Console Redirection on the client system. The following is an example on Windows platform:
 - a. A. Click the start button, point to Programs > Accessories > Communications and select Hyper Terminal.
 - b. B. Enter any name for the new connection and select any icon.
 - c. Click OK.
 - d. From the "Connect to". Pull-down menu, select the appropriate Com port on the client system and click OK.
 - e. Select 115200 for the Baud Rate, None. for Flow control, 8 for the Data Bit, None for Parity Check, and 1 for the Stop Bit.

Appendix C: Programming Generation 3 LAN Bypass

The bypass function is used to link two independent Ethernet ports when the system crashes or powers off. This means if your system is equipped with a LAN Bypass function, a condition in your system will not interrupt your network traffic. Different from the previous two generations (Gen1 and Gen2), the Lanner Bypass Gen 3 employs a programming method to control the bypass function by software. There are typically two communication status for the bypass function, one is "Normal" and another is "Bypass" status.

Furthermore, the Lanner Bypass software is capable to control the bypass status in the following 3 instances.

1. When the system powers off, it can be forced to enable the LAN Bypass function.
2. When the system is in the just-on state which is a brief moment when it powers up.
3. When the system is running

Lanner bypass possess the following features:

1. Communication through SMBUS (I2C)
2. Independent bypass status control for each pair up to a total of 4 pairs
3. Lanner Bypass Modules can bypass systems Ethernet ports on a host system during three instances: Just-on (Just-on is the brief moment when the internal power supply turns on and booting process starts), System off, or upon software request (during run-time).
4. Software programmable bypass or normal mode
5. Software programmable timer interval:
 - JUST-ON watchdog timer, used during JUST-ON, has timer setting of 5~1275 seconds of timer interval.
 - Run-Time watchdog timer, used during run-time, has setting of 1~255 seconds of timer interval.
6. Multiple Watchdog Timers:
 - Two for run-time: It is designed to give you a more variety of controls of the bypass on port basis. By using dedicated watchdogs for different pairs of bypass, you have the flexibility to manage the bypass status for them differently.
 - One for just-on: It is designed to give you the precise control of the bypass during this phase.

You can use this timer to delay enabling the bypass in just-on state.

-For sample LAN bypass code and the Bypass Manual, see the *LAN_Bypass* folder on the *Lanner Support Website* a <http://www.lannerinc.com/download-center/> and browse the *download center* and look for *Lanner LAN Bypass Watchdog User Manual* under the *Accessories folder*.

-For a description of the physical LAN ports equipped with this function, refer to *Front Panel Features* in *Chapter1 Introduction*.

Appendix D: Programming the LCM

The LCD panel module (LCM) is designed to provide real-time operating status and configuration information for the system. For sample LCM code, see *LCM* folder in the *Driver and Manual CD*. The driver and the program library can also be found in the folder.

The system supports the following 2 kinds of LCM:

- Parallel Text-based LCM: The LCM connects to the motherboard's parallel port. The LCD screen can display 2 lines, 16 (or 20) characters per line.
- USB and Serial Text or Graphic-based LCM: Our next generation LCM. Lanner engineers design a common source code to be deployed on these two differently interfaced LCM modules. Jumpers are used to select between text and graphic types. See next section.

For Parallel Text-based LCM

Build

To build program source code on Linux platform, please use the following steps as a guideline:

1. Extract the source file:

```
# tar -xvzf plcm_drv_v0XX.tgz
```

(0XX is the version of the program.)

2. Change directory to the extracted folder:

```
# cd plcm_drv_v0XX
```

(0XX is the version of the program.)

NOTE: Apply our Parallel Text-based LCM to the environment of virtualization, please use the version 013 or above of the program.

3. Type "make" to build source code:

```
# make
```

After compiling, the executable programs (plcm_test, plcm_cursor_char, ppdev_test, Test) and the driver (plcm_drv.ko) will appear in the program's folder.

NOTE: The OS supported by Parallel Text-based LCM function includes platforms based on Linux Kernel series 2.4.x, Linux Kernel series 2.6.x and Linux Kernel series 3.0.x or above.

Install

Install the driver and create a node in the /dev directory by:

```
#insmod plcm_drv.ko
```

```
#mknod /dev/plcm_drv c 248 0
```

NOTE:

If you cannot install the driver, check whether you have enabled the parallel port in the BIOS setting . Once the message of "insmod": error inserting 'plcm_drv.ko': -1 Input/output error" appears, please check that whether the major number is repeated or not. The major number needed with the "mknod" command varies with different software versions; please look up the Readme file for this value.

Execute

This section contains sample executable programs that you could test on your platform. It demonstrates some useful functionality that the LCM provides. Note that the installation needs to be completed before proceeding with these executions.

To execute, run the command:

#./plcm_test

Backlight Off/On turning off/on the backlight of the LCM display

Display Off turning off the LCM display

Cursor Off/On NOT showing/showing the cursor on the LCM display

Blinking off/On turning off/on the cursor blinking

Writing "Lanner@Taiwan" displaying the specific sentences

Reading "Lanner@Taiwan" reading the specific sentence

CGram Test displaying the user-stored characters

Keypad Testing Get the keypad input: the 1st button is read in as Left, the 2nd button is read in as Up, the 3rd button is read in as Right, and the 4th button is read in as Down)

Corresponding Commands for "plcm_test"

You can directly input the specific command to have its corresponding function worked on your LCM. This will be much more convenient once you would like to merely execute the keypad testing.

-On

— Turn on the backlight of the LCM display.

— To execute, please type:

#./plcm_test -On

-Off

— Turn off the backlight of the LCM display.

— To execute, please type:

#./plcm_test -Off

-LCM1

— Writing "Lanner@Taiwan" in line1.

— To execute, please type:

#./plcm_test -LCM1

-LCM2

— Writing "2013-11-05" in line 2.

— To execute, please type:

#!/plcm_test -LCM2

Keypad

— Get the keypad input: the 1st button is read in as Left, the 2nd button is read in as Up, the 3rd button is read in as Right, and the 4th button is read in as Down.

— To execute, please type:

#!/plcm_test -Keypad

Commands for plcm_cursor_char

This Run this command for cursor shift & single text update

./plcm_cursor_char

Please read the options below

Insert line select Item 1 to set the starting line as either line 1 or line 2

Move cursor right select Item 2 to move the cursor to the right

Move cursor left select Item 3 to move the cursor to the left

Add a char select Item 4 to display a character on the LCM screen

Clean display select Item 5 to clear up the LCM display

Leave select Item 6 to exit the program

Test

This program is a testing script and runs through the following procedures in sequence:

— **rmmod plcm_drv** (remove the kernel mode driver module)

— **insmod plcm_drv.ko** (install the kernel mode driver module)

— **./plcm_test** (execute the driver testing program)

— **./plcm_test -stop** (stop executing the driver testing program)

— **rmmod plcm_drv** (remove the kernel mode driver module)

To execute, please type:

#!/Test

Virtualization Implemented by Parallel

Port Pass Through

By the utilization of the parallel port pass through, the Parallel Text-based LCM implements the following three kinds of virtualization in the Guest OS.

- QEMU/KVM

- Xen

- VMWare Player

Here, we take the Fedora 20 x86_64 operation system for instance to explain 3 virtualization respectively for parallel port pass through. Use the procedures listed below for step-by-step instructions separately based on your case.

In case of QEMU/KVM or Xen, please use the following steps as a guideline to implement the virtualization :

- (1) Make sure that the Guest OS has been installed.
- (2) Add the following 4 lines into the xml file (for example, add to /etc/libvirt/qemu/<yourvirtualmachine>.xml in linux KVM):

```
<parallel type='dev'>
<source path='/dev/parport0'/>
<target port='0'/>
</parallel>
```

- (3) Open a terminal in the Guest OS and then issue the following commands to install Linux Kernel drivers.

```
# modprobe parport
# modprobe parport_pc
# modprobe ppdev
```

- (4) Check that whether the /dev/parport0 exists or not. You may not find proper /dev/parport0 in the device list, please reconfirm the setup of xml file in the Guest OS.

- (5) Reboot the Guest OS.

Note: It is necessary for you to install "insmod parport.ko", "parport_pc.ko" and "ppdev.ko" Linux Kernel drivers in virtualization environment before executing the "ppdev_test" testing program.

In case of VMWare Player, please use the following steps as a guideline to implement the virtualization:

- (1) Make sure that the Guest OS has been installed.
- (2) To set up the parallel port pass through, please enter VMWare Player's --> Virtual Machine Setting --> VMWare Player's setting page to select /dev/parport0 as parallel port device.

- (3) Open a terminal in the Guest OS and then issue the following commands to install Linux Kernel drivers.

```
# modprobe parport
# modprobe parport_pc
# modprobe ppdev
```

- (4) Check that whether the /dev/parport0 exists or not. You may not find proper "/dev/parport0" in the device list, please reconfirm the setup of VMWare Player's setting page described in Step 2.

- (5) Reboot the Guest OS.

Note: It is still necessary for you to install "insmod parport.ko", "parport_pc.ko" and "ppdev.ko" Linux Kernel drivers in virtualization environment before executing the "ppdev_test" testing program.

Appendix E: Terms and Conditions

Warranty Policy

1. All products are under warranty against defects in materials and workmanship for a period of one year from the date of purchase.
2. The buyer will bear the return freight charges for goods returned for repair within the warranty period; whereas the manufacturer will bear the after-service freight charges for goods returned to the user.
3. The buyer will pay for repair (for replaced components plus service time) and transportation charges (both ways) for items after the expiration of the warranty period.
4. If the RMA Service Request Form does not meet the stated requirement as listed on "RMA Service," RMA goods will be returned at customer's expense.
5. The following conditions are excluded from this warranty:
 - Improper or inadequate maintenance by the customer
 - Unauthorized modification, misuse, or reversed engineering of the product
 - Operation outside of the environmental specifications for the product.

Requesting a RMA#

1. To obtain a RMA number, simply fill out and fax the "RMA Request Form" to your supplier.
2. The customer is required to fill out the problem code as listed. If your problem is not among the codes listed, please write the symptom description in the remarks box.
3. Ship the defective unit(s) on freight prepaid terms. Use the original packing materials when possible.
4. Mark the RMA# clearly on the box.

Note: Customer is responsible for shipping damage(s) resulting from inadequate/loose packing of the defective unit(s). All RMA# are valid for 30 days only; RMA goods received after the effective RMA# period will be rejected.

RMA Service Request Form

When requesting RMA service, please fill out the following form. Without this form enclosed, your RMA cannot be processed.

RMA No:	Reasons to Return: <input type="checkbox"/> Repair(Please include failure details) <input type="checkbox"/> Testing Purpose
Company:	Contact Person:
Phone No.	Purchased Date:
Fax No.:	Applied Date:
Return Shipping Address: _____	
Shipping by: <input type="checkbox"/> Air Freight <input type="checkbox"/> Sea <input type="checkbox"/> Express _____	
<input type="checkbox"/> Others: _____	

Item	Model Name	Serial Number	Configuration

Item	Problem Code	Failure Status

*Problem Code:

- | | | | |
|------------------------|------------------------------|--------------------|--------------------------|
| 01: D.O.A. | 07: BIOS Problem | 13: SCSI | 19: DIO |
| 02: Second Time R.M.A. | 08: Keyboard Controller Fail | 14: LPT Port | 20: Buzzer |
| 03: CMOS Data Lost | 09: Cache RMA Problem | 15: PS2 | 21: Shut Down |
| 04: FDC Fail | 10: Memory Socket Bad | 16: LAN | 22: Panel Fail |
| 05: HDC Fail | 11: Hang Up Software | 17: COM Port | 23: CRT Fail |
| 06: Bad Slot | 12: Out Look Damage | 18: Watchdog Timer | 24: Others (Pls specify) |

Request Party

Confirmed By Supplier

Authorized Signature / Date

Authorized Signature / Date